

USER'S MANUAL

TFMX-IIC TYPE-2

TFMX-C
(single head machine)

TWMX-C

TFMX (L)

How to perform embroidery

1. To turn ON the power	34
2. Thread passing, fabric setting	37
3. Registration of a design into the machine memory	41
4. Decision of an embroidery design and the color change sequence	50
5. Decision of the design start position	57
6. Check items before embroidering	64
7. Embroidery starts	68



Foreword

This user's manual describes about the correct using method and instructions for use of this product. Please use this machine after understanding the contents of the manual.

This manual may contain discrepancies in detailed specifications as compared with the actual production models. If you have any questions about this manual, consult your TAJIMA distributor.

We believe that "BASICS TAJIMA EMBROIDERY MACHINES" and "MACHINE SETUP INSTRUCTIONS" are useful to deepen your knowledge about this product. Please also read those booklets.

Regarding how to handle the products related, refer to the user's manual exclusive for them included in the manual CD.

Tokai Industrial Sewing Machine Co., Ltd.

SAFETY PRECAUTIONS

To prevent any harm or damage to the person who use this product or other person, we describe items that must be surely followed as below.



Indicates that there is a lot of danger of death or serious injuries [*1] if handled by mistake.



Indicates that there is a likelihood of death or serious injuries [*1] if handled by mistake.





Indicates a potentially hazardous situation which may result in minor or moderate injury [*2] or property damage if handled by mistake.

*1: A condition caused by electric shock, injury, fracture of a bone, etc., that leads to aftereffects, or an injury that necessitates hospitalization or visits to a hospital over a long period.

*2: An injury that does not necessitate hospitalization or visit to a hospital over a long period.

 : Prohibited items

 : Items that may cause electric shock if not observed

 : Items that must be followed carefully to ensure safe operation

Chapter 1 Items that must be followed carefully

1. Safety Precautions	2
1-1. WARNING	2
1-2. CAUTION	4
2. Important warning items for safe operation (UL and CSA-spec.)	6
3. Warning labels	9
4. Inspection before starting work	12

Chapter 2 Name and way to use of each part

1. Name of each part	14
1-1. TFMX-C single-head machine	14
1-2. TWMX-C	15
1-3. TFMX-IIC TYPE-2	16
1-4. TFMX (L)	17
2. How to use each part	18
2-1. Operation panel	18
2-2. Sleep mode key	21
2-3. Emergency stop switch	22
2-4. Needle Base LED Lamp	23
2-5. Jog remote-controller (Option for some models)	23
2-6. Table offset switch	24

Chapter 3 Screen

1. Screen display	26
1-1. Main screen	26
1-2. List screen	28
1-3. Setting screen	28
1-4. Character/numeric value input screen	28
1-5. Design confirmation screen	29

2.	Message display.....	31
2-1.	Condition data	31
2-2.	Start point of design	32
2-3.	Offset Return.....	32

Chapter 4 How to perform embroidery

1.	To turn ON the power.....	34
1-1.	Power switch	34
1-2.	To turn ON the power.....	36
2.	Thread passing, fabric setting	37
2-1.	Thread passing.....	37
2-2.	To set fabric to embroidery frame	40
3.	Registration of a design into the machine memory	41
3-1.	To use USB memory (Data Input USB).....	41
3-2.	To use personal computer (Data Input LAN).....	45
4.	Decision of an embroidery design and the color change sequence.....	50
4-1.	To decide embroidery design (Data Setting).....	50
4-2.	To decide color change sequence (Needle Bar Selection).....	53
4-3.	To change color automatically / to start operation automatically (Auto Color Change "AC" / Auto Start "AS")55	
5.	Decision of the design start position.....	57
5-1.	To check design size and setting contents of design (Check of design).....	57
5-2.	To lower the needle bar to adjust the frame position (Needle bar operation)	58
5-3.	To move frame to the design start position (Manual frame travel).....	59
5-4.	To check if design fits in embroidery space (Trace).....	62
6.	Check items before embroidering	64
6-1.	Maximum speed (Maximum RPM).....	64
6-2.	Embroidery head	66
7.	Embroidery starts	68
7-1.	Start and stop	68
7-2.	Frame Back (to return the frame) / Frame Forward (to advance the frame)	69
7-3.	Handling of thread breakage	73
7-4.	Completion of embroidery	75

Chapter 5 Functions concerning embroidery

- 1.** To change color..... 78
 - 1-1.** To change color manually (Manual Color Change)..... 78
- 2.** To trim thread 79
 - 2-1.** To trim thread manually (Manual Thread Trimming) 79
 - 2-2.** To trim thread automatically (ATH) 80
 - 2-3.** To change thread breakage detecting sensitivity (Thread Detection)..... 83
 - 2-4.** To trim thread by the number of consecutive jump stitches (Jump Convert) 85
 - 2-5.** To add thread trimming code to the design and trim thread (Data Edit "Insert")..... 86
 - 2-6.** To change thread trim timing (ATH Start Timing)..... 88
- 3.** To set the embroidery speed..... 89
 - 3-1.** To limit embroidery speed by stitch length (Min. Revolution)..... 89
 - 3-2.** To set embroidery speed within speed limit section (Revolution limit)..... 90
 - 3-3.** To decide upper limit value of the maximum speed (Max. Revolution Limit) 91
- 4.** To stop the machine..... 92
 - 4-1.** To stop the machine automatically when reaching the set value (Preset Halt)..... 92
 - 4-2.** To stop the machine before needle bar hits the frame (Software Frame Limit) 93
 - 4-3.** To stop the machine with needle bar stuck in the material (Stop at Lower D.Point)... 95
 - 4-4.** To stop at Frame Limit (Frame Limit setting) 96
- 5.** To change the direction and the size of the design..... 98
 - 5-1.** To perform enlargement, rotation, reversion (Data Conversion)..... 98
- 6.** To embroider the same design repeatedly 100
 - 6-1.** To repeat to horizontal and vertical direction (Repeat) 100
 - 6-2.** To repeat at the same place (A.S. after Auto Data Set)..... 103
- 7.** To adjust finishing of embroidering 104
 - 7-1.** To adjust driving error of the frame (Backlash) 104
 - 7-2.** To adjust stitch length of satin stitch (Satin Stitch)..... 105
 - 7-3.** To divide a long stitch (Auto Jump)..... 107
 - 7-4.** To change stitching condition in every needle bar (Setting in units of Needle bar)... 108
 - 7-5.** To delete tiny stitch (Cleanup)..... 111
 - 7-6.** To change thread tension (Frame Start Timing) 113

7-7.	Not to stand out the edge of upper thread (Upper thread lock timing)	114
7-8.	To adjust stitching length according to a stitch length (Frame Drive Adjustment).....	115
8.	To increase embroidering efficiency.....	117
8-1.	To change number of lowering needle bar at slow operation (Main Shaft Inching) ..	117
8-2.	To collect up frame moving amount of consecutive jump stitches in a batch to feed the frame all at once (Jump code combination).....	117
8-3.	To change moving speed of needle bar case (Color change speed).....	118
8-4.	To change travel speed of the frame (Frame Travel Speed)	119
8-5.	To set data of the design automatically after the embroidery is finished (Automatic Data Set after finishing embroidery).....	120
9.	To edit design.....	122
9-1.	To modify the stitch (Data Edit "Modify").....	122
9-2.	To insert the stitch (Data Edit "Insert")	126
9-3.	To delete the stitch (Data Edit "Delete").....	130
10.	Setting and resetting of password.....	133
10-1.	To change password (Functional Limit of Password).....	133
10-2.	To cancel the password	135
11.	Functions that must be remembered.....	136
11-1.	To check the number of total stitches up to now (Total Stitch Counter).....	136
11-2.	To color in every needle bar (Needle Bar Color).....	137
11-3.	To display the setting color when making the design (Needle bar information).....	138
11-4.	To check version of current software (Software Version).....	139
11-5.	To switch display language (Language).....	140
11-6.	To release fixing of main shaft motor (weak brake)	141
11-7.	To display/Not to display the screen for reading Condition data (Input confirmation of condition file)143	

Chapter 6 Functions concerning frame movement

- 1.** To return the frame (Frame Back) / to advance the frame (Frame Forward) 146
 - 1-1.** To switch Frame Back / Frame Forward 146
 - 1-2.** To execute by Stop code, to specify number of stitches to execute..... 147
 - 1-3.** To change a frame feed amount of frame back / frame forward 149
 - 1-4.** To set All Head Sewing Start Point (Frame Back All Head Sew) 150
- 2.** Necessary works after replacing the frame 152
 - 2-1.** To change frame type..... 152
 - 2-2.** To rotate the design by 180 degrees when a cap frame is equipped
(Design rotation by 180 degrees on Cap Frame) 155
- 3.** To return the frame to the original position 156
 - 3-1.** To return the moved frame to the previous position (Manual Offset) 156
 - 3-2.** To return moved frame to original position and start operation
(Return the frame after manual frame travel) 157
 - 3-3.** To prevent displacement of design when the power is shut off during operation
(Power resume) 158
 - 3-4.** To memorize frame origin (Frame origin memory) 159
 - 3-5.** To perform Frame origin memory when the power is turned ON
(Frame origin memory with the power-ON)160
- 4.** To return the frame to the design start position..... 162
 - 4-1.** To return the frame to the design start position manually
(Return to the design start position)..... 162
 - 4-2.** To return the frame to the design start position automatically (Auto Origin Return).. 163
- 5.** To move the frame to the position registered 164
 - 5-1.** To move the frame automatically at the start and the end of embroidery
(Automatic Offset) 164
 - 5-2.** To move the frame automatically at the start,
in the middle and the end of embroidery 166
 - 5-3.** To return the frame to the offset start position manually
(Return to the offset origin) 168
- 6.** To register frame position 169
 - 6-1.** To register the frame position to make threading easily (table offset position) 169

Chapter 7 Function concerning storing and deleting of design

1. Design stored in the machine memory.....	172
1-1. To delete a design (Memory Delete).....	172
1-2. To move a design (Movement of design).....	173
1-3. To copy a design (Copy a design).....	174
1-4. To change the file name of the design (Changing design name).....	176
1-5. To change a folder name (Changing folder name).....	178
1-6. To sort a design (Design sort "in memory").....	180
1-7. To store a design to a USB memory (USB "Save").....	182
2. Design saved in USB memory	184
2-1. To delete a design (USB Delete).....	184
2-2. To sort a design (Design sort "USB")This function sorts designs in the machine memory by turns from the front. The folder is displayed in advance of design.	186

Chapter 8 Setting for optional device

1. To make optional device available for use	190
1-1. Sequin Device (common to III and IV).....	190
1-2. Automatic Lubrication System.....	192
1-3. Network	193
1-4. Lochrose embroidery device	194
1-5. Cording Device.....	196
1-6. Boring Device II	197
1-7. Bobbin changer	198
2. To set details of optional device	200
2-1. Sequin Device III	200
2-2. Sequin device IV	204
3. Functions concerning optional device	206
3-1. To make the air compressor available for use (Air Pressure Sensor).....	206
3-2. To reverse the 1st color and the 2nd color in sequin device III (Data conversion for sequin output)	207
3-3. To change color by using DST design in sequin III (Needle bar selection).....	209
3-4. Lochrose counter.....	211

Chapter 9 Countermeasure when some trouble occurs in the machine

1. Countermeasure when the machine stopped	214
1-1. Normal stop.....	214
1-2. Abnormal stop.....	215
1-3. Stop due to malfunction	217
2. Trouble examples and Corrective actions.....	221
2-1. Thread breakage is highly visible.....	221
2-2. Needle breaks.....	222
2-3. Bad finishing of sewing	222
2-4. To suspend the error head.....	223





Chapter 10 Maintenance and Inspection

1. Items that must be followed carefully.....	226
2. Cleaning.....	227
3. Lubrication.....	229
4. Greasing.....	232
5. Inspection, Repair	235

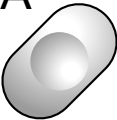
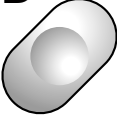
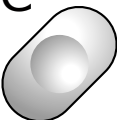
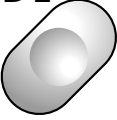
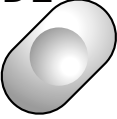

Chapter 11 Appendix

1. Spec. of the machine	238
1-1. Power supply specifications	238
1-2. Ambient noise level.....	238
1-3. Switching of input voltage (some spec. only).....	239
1-4. Layout of electrical component, card	241
1-5. Machine weight	242
2. Function code.....	243
2-1. Function codes that can be edited by this machine	243
2-2. Function codes that cannot be edited by this machine (display only).....	244
3. Electrical system diagram	245
3-1. Single-head machine	245
3-2. TFMX-IIC TYPE-2, TFMX (L).....	246
4. Terminology	247

Menu key	Title	Operation in the middle of embroidery Enable○/ Unable×
A 	1 Data Input (Memory)50	○
	4 Data Input (USB).....41	○
	5 Data Input (LAN)45	○
	8 Memory Delete.....172	○
B 	1 Auto Color Change (AC) / Auto Start (AS)55	○
	2 Needle Bar Selection53	○
	3 Data Conversion98	×
	4 Repeat.....100	×
	5 Automatic offset164	×
	6 Automatic Start after Automatic Data Set103	○
	10 Needle Bar Color.....137	○
C 	1 Maximum RPM.....64	○
	2 Total Stitch Counter / Design Timer136	○
	3 Frame Back/Frame Forward146	○
	5 Frame Back All Head Sew150	○
	6 Preset Halt92	○
	7 Frame type152	×
	10 Stop at Lower D. Point95	○
D1 	1 Trace62	×
	2 Manual Color Change78	○
	3 Manual Thread Trimming79	○
	4 Return to the design start position162	○
	5 Manual Offset.....156	○
	6 Return to the offset origin.....168	○
	10 Needle bar operation.....58	○
D2 	1 Manual device - Up/Down..... --- Refer to the separate manual for the optional device.	Sequin device IV Lochrose embroidery device

F1 	1 Jump Convert 85	○
	2 Auto Jump 107	○
	3 Satin Stitch 105	○
	4 Backlash 104	○
	5 Jump Code Combination 117	○
	6 Software Frame Limit 93	×
F2 	1 Min. Revolution 89	○
	2 Revolution Limit 90	○
	3 Main Shaft Inching 117	○
	4 Automatic Origin Return 163	○
	5 Frame Travel Speed 119	○
	6 Thread Detection 83	○
	9 ATH 80	○
	10 Upper thread lock timing 114	○
F3 	1 Boring 197	×
	2 Sequin 200 (Sequin Device III)	○
	2 Sequin 204 (Sequin Device IV)	
	3 Cording 196	×
	6 Lubrication 192	○
	9 Bobbin Changer 198	○
	10 Lochrose embroidery device 194	×
 	1 Data Edit 122 (Modification)	○
	1 Data Edit 126 (Insertion)	○
	1 Data Edit 130 (Deletion)	○
	2 Cleanup 111	○
	4 Move a design 173	○
	5 Copy a design 174	○
	6 Changing design name 176	○
	7 Changing folder name 178	○
9 Data conversion for sequin output 207	○	

To search from the menu key

	6 USB (Save) 182	○
		7 USB (Delete) 184
SET+A	1 Design sort (in memory) 180	○
	4 Design sort (USB) 186	○
	8 Input confirmation of condition file 143	○
	9 Automatic data set after end of embroidery 120	○
SET+B	1 Design rotation by 180° on Cap Frame 155	×
	10 Needle Bar Information 138	○
SET+F1	1 Password (Functional Limit) 133	○
	3 Setting in units of Needle bar 108	○
	6 Frame Limit Setting 96	○
	7 Frame origin memory with the power-ON 161	○
SET+F2	1 Max. Revolution Limit 91	○
	2 Frame Start Timing 113	○
	3 Frame Drive Adjustment 115	○
	4 ATH Start Timing 88	○
	5 Table Offset Position 169	×
	6 Return the frame after manual frame travel 157	○
	8 Power Resume 158	○
	9 Frame Origin Memory 159	×
SET+F3	2 Weak Brake 141	○
	3 Air Pressure Sensor 206	○
	7 Sequin device 190	×
	10 Network 193	○
SET+F4	8 Software Version 139	○
	10 Language 140	○

To search from the menu key

Chapter 1

Items that must be followed carefully















1. Safety Precautions.....	2
2. Important warning items for safe operation (UL and CSA-spec.)	6
3. Warning labels	9
4. Inspection before starting work.....	12

1. Safety Precautions

1-1. WARNING

To prevent accidents resulting in injury or death and physical damage, the following items must be observed strictly when operating the machine.

WARNING

-  This machine is designed for industrial use. Use this machine for semi- or finished textile products and similar materials. Using the machine for other purposes must be avoided.
-  Do not stand on the machine.
-  For the machine model with the bar switch, using the bar switch as a grip to support yourself is strictly prohibited.
-  Do not use a device such as a cellular phone that generates microwave near the control circuits of the power supply box, the operation panel box, etc. Microwave may cause malfunctioning of the machine.
-  Do not detach covers for the shaft and the pulley. Also, do not run the machine without the covers.
-  Do not have your hands, etc. access to the vicinity of needle during operation. Otherwise, sticking of needle could injure you.
-  During operation, do not access your hands and/or face to moving sections. Especially, it is dangerous around needle, rotary hook, take-up lever, pulley and speed-reduction box.
-  This machine uses strong magnet. The person, who is mounted with internal implantable medical electronics like a pacemaker, should not use this machine. The person who is mounted with a equipment described above also should not access to magnet inside of this machine. This internal equipment could malfunction.
-  Read this book thoroughly and understand the contents of operation certainly. Then, operate the machine.
-  Wear proper clothes and tidy up yourself so that you can smoothly perform the operation.
-  A single operator should operate the machine in principle. If plural operators are working together, make sure that no one is working near the moving units of the machine before starting the machine.
-  Use the machine under the environment where access can be supervised so that unauthorized person does not operate the machine. Supervise children so that they do not access to the machine.
-  Only the persons who are sufficiently trained for the operation must operate the machine.
-  The rear of the machine is not a working area. If you have to move to the rear of the machine, make sure to turn OFF the main switch.

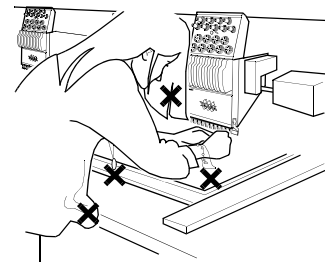
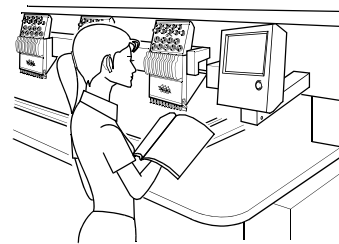
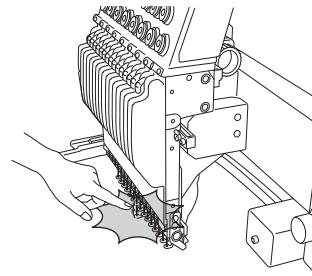

! WARNING

- ! Stop the machine before threading into the needle and checking the finish of embroidery.
- ! For the machine model with the sub table, lift up and fix the sub table securely after threading and/or adjusting the machine.
- ⚠ Do not damage, modify or heat the power or other cables. Do not exert undue force to them, either. Otherwise the cables will be damaged causing fire and electric shock.
- ⚠ Insert the power cable plug fully. If a metallic part etc. touches an electrode in the plug, it may cause fire and/or electric shock.
- ⚠ Keep away electrical units from water and chemicals. Entry or splashing of them into electrical units leads to short circuits, causing fire, electric shock and other troubles. If water or other chemicals enter the unit, turn OFF the power switch, shut OFF the primary power of the machine and contact your local distributor.

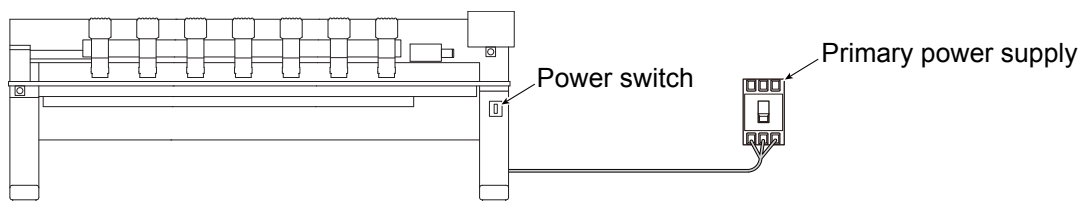





- ⚠ Before opening the electrical boxes, be sure to turn OFF the power switch of the machine and shut OFF the primary power. If not, it may cause electric shock.

1-2. CAUTION





When operating the machine, the following items must be observed strictly to prevent accidents resulting in injury or death and property damage.

CAUTION

-  Use the machine with about 70% of the maximum speed as "Operation for total fitting" for about one week after installing this machine. By performing operation for total fitting, life of the machine will become longer, which will be useful to avoid unexpected troubles.
-  Do not use bent needles or needles that are not suitable for the material. Be sure to turn OFF the power switch after working, and turn OFF the primary power supply.
-  Do not put things on the machine table.
-  This machine uses strong magnet. This machine including magnet should not be accessed to a cellular phone, an analogue watch, a floppy disk, a magnetic card, a magnetic tape or a magnetic ticket.

In addition to full-time leak current, leak electric current generated by harmonics and surge flows in the power cable of the machine. For this reason, if selection and installation of breaker of leak current and leak current relay used for the factory are not correct, malfunctioning of the machine may occur.

Regarding connection of power cord, observe the following items.

-  Use a breaker of electric current leakage and leak current relay for which measures are taken against harmonics and surge. If you use conventional breaker and relay without such measures, select with sufficient leak current capacity to fill up leak current by harmonics and surge. (In this case, leak current must be controlled constantly satisfactorily.)
-  Regarding capacity of electric current leakage for leakage breaker and leak current relay necessary per machine, consult your local TAJIMA distributor.
-  For actual product names of breaker of electric current leakage and leak current relay for which measures are taken against harmonics and surge, please consult your local TAJIMA distributor or electric engineers.
-  To prevent the machine from property damages (the power decline of the main shaft motor, etc., stop position error and its color change error, design displacement, etc), one embroidery machine should be connected to one no fuse breaker in regard to connecting power harness.

! CAUTION

! Control the operation noise in the environment.

This machine is designed to reduce noise during operation. To improve the sound insulation performance in a factory still more, use the interior finish materials which show high sound insulating performance for the walls, ceiling, and floor of the factory.

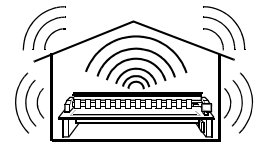

! Install the machine on a sturdy floor.

The floor structure must be strong enough to bear the machine weight (indicated on the spec. plate).

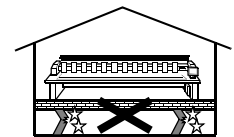

! Avoid dust and moisture.

Since dust and moisture lead to dirt and rust on the machine, use the machine in an environment of facility of air conditioner, and clean the working place periodically. Use caution not to expose the machine to direct wind from the air conditioner so that embroidery threads do not become disheveled.

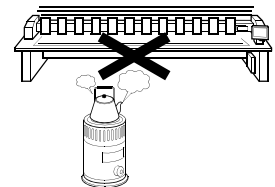

Humidity:

30 to 95% RH (relative humidity) without condensation

Ambient temperature:

5 to 40°C (during operation), -10 to 60°C (during storage)

! Avoid direct sunlight.

If the machine is exposed to direct sunlight over an extended period of time, the machine body may be discolored or deformed. Put curtains or shades to prevent the machine from direct sunlight.

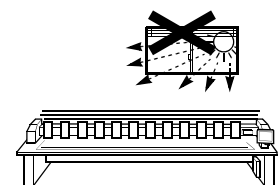

! Provide enough space for maintenance.

Taking account of workability when maintaining and inspecting the machine, provide 50 cm or more working area to right, left and rear directions of the machine against obstacles such as walls.

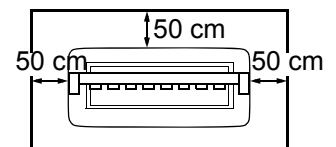

! Pay attention to interference of radio wave.

Although the machine is designed not to affect radio wave interference to other equipments, there could be cases where it causes interference depending on operation environment and type of other equipment. If such problems arise, install the equipment with a space from the machine as big as possible.

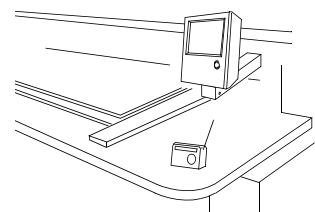

1
2
3
4
5
6
7
8
9
10
11

2. Important warning items for safe operation (UL and CSA-spec.)

The following contents explains about UL, and CSA spec. machines.

IMPORTANT SAFETY INSTRUCTIONS

(applied to UL-spec. and CSA-spec. machines)

UL is safety standard applied to USA and CSA is safety standard applied to Canada.

Read all instructions before using this appliance

When using an electrical appliance, basic safety precautions should always be followed, including the following:











DANGER

To reduce the risk of electric shock:







-  An appliance should never be left unattended when plugged in. Always unplug this appliance from the electric outlet immediately after using and before cleaning.

WARNING

To reduce the risk of burns, fire, electric shock, or injury to persons:

-  Do not allow to be used as a toy. Close attention is necessary when this appliance is used by or near children.
-  Use this appliance only for its intended use as described in this manual. Use only attachments recommended by the manufacturer as contained in this manual.
-  Never operate this appliance if it has a damaged cord or plug, if it is not working properly, if it has been dropped or damaged, or dropped into water. Please consult the nearest authorized dealer or service center and use this appliance after the examination, repair, electrical or mechanical adjustment has been made.
-  Never operate the appliance with any air openings blocked. Keep ventilation openings of the sewing machine free from the accumulation of lint, dust, and loose cloth.
-  Keep fingers away from all moving parts. Special care is required around the sewing machine needle.
-  Always use the proper needle plate. The wrong plate can cause the needle to break.
-  Do not use bent needles.
-  Do not pull or push fabric while stitching. It may deflect the needle causing it to break.
-  Switch the sewing machine off ("O") when making any adjustments in the needle area, such as threading needle, changing needle, threading bobbin, or changing presser foot, etc.
-  Always unplug sewing machine from the electrical outlet when removing covers, lubricating, or when making any other user servicing adjustments mentioned in the instruction manual.

 **WARNING**

-  Never drop or insert any object into any opening.
-  Do not use outdoors.
-  Do not operate where aerosol (spray) products are being used or where oxygen is being administered.
-  To disconnect, turn all controls to the off("O") position, then remove plug from outlet.
-  Do not unplug by pulling on cord. To unplug, grasp the plug, not the cord.
-  Connect this appliance to a properly grounded outlet only. See Grounding Instructions.



SAVE THESE INSTRUCTIONS

GROUNDING INSTRUCTIONS

(applied to UL-spec. and CSA-spec. machines)

This product must be grounded. In the event of malfunction or breakdown, grounding provides a path of least resistance for electric current to reduce the risk of electric shock. This product is equipped with a cord having an equipment-grounding conductor and a grounding plug. The plug must be plugged into an appropriate outlet that is properly installed and grounded in accordance with all local codes and ordinances.

 **DANGER**

-  Improper connection of the equipment-grounding conductor can result in a risk of electric shock. The conductor with insulation having an outer surface that is green with or without yellow stripes is the equipment-grounding conductor. If repair or replacement of the cord or plug is necessary, do not connect the equipment-grounding conductor to a live terminal.
-  Check with a qualified electrician or serviceman if the grounding instructions are not completely understood, or if in doubt as to whether the product is properly grounded.
-  Do not modify the plug provided with the product - if it will not fit the outlet, have a proper outlet installed by a qualified electrician.

! DANGER

! This product is for use on a nominal 120V circuit, and has a grounding plug that looks like the plug illustrated in sketch A in Figure-1. A temporary adaptor, which looks like the adaptor illustrated in sketches B and C, may be used to connect this plug to a 2-pole receptacle as shown in sketch B if a properly grounded outlet is not available. The temporary adaptor should be used only until a properly grounded outlet can be installed by a qualified electrician. The green colored rigid ear, lug, and the like, extending from the adaptor must be connected to a permanent ground such as a properly grounded outlet box cover. Whenever the adaptor is used, it must be held in place by the metal screw.

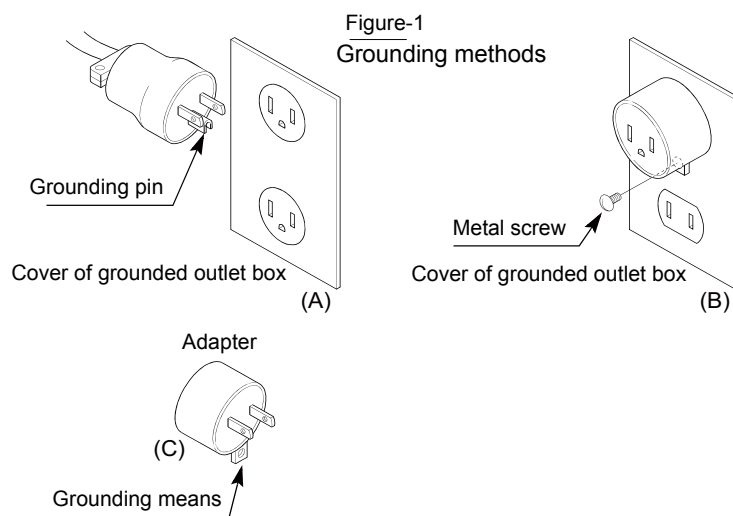

3. Warning labels

The machine has warning labels that bear instructions for safe operation. When using the machine, machine operators must follow the instructions shown on the warning labels.

Do not detach the warning label nor make the printing surface illegible by paint etc. If the warning label is missed or damaged, contact your local distributor.

[TFMX-C single-head machine]

A Pay attention not to be caught into the machine.



D High voltage indication mark



There could be danger of electric shock, burning, or death. Persons except the service personnel designated by Tajima should not open the covers.

When you open the cover, turn OFF the power switch and wait for four minutes.

B Pay attention around needle.

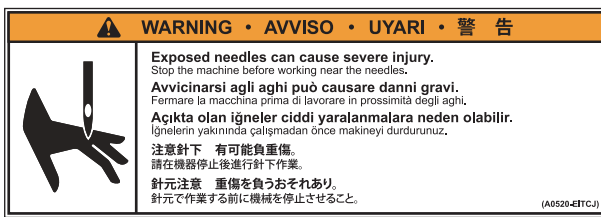

E Catching mark



There could be danger of being caught or clipped. Persons except the service personnel designated by Tajima should not open the covers.

C Pay attention to rotary hook.

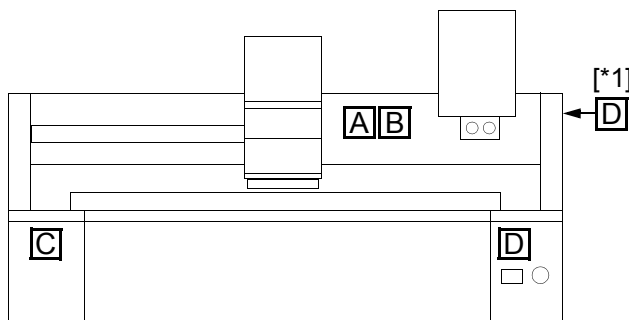

[*1] To be affixed on the right-side box cover

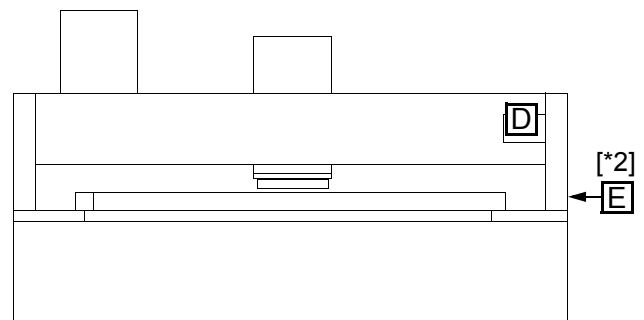

[*2] To be affixed on the left-side box cover

- 1
- 2
- 3
- 4
- 5
- 6
- 7
- 8
- 9
- 10
- 11

[2 or more heads machine]

A Pay attention not to be caught into the machine.

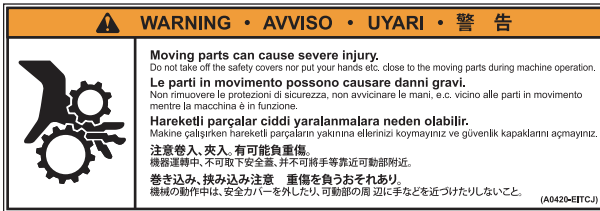

B Pay attention around needle.

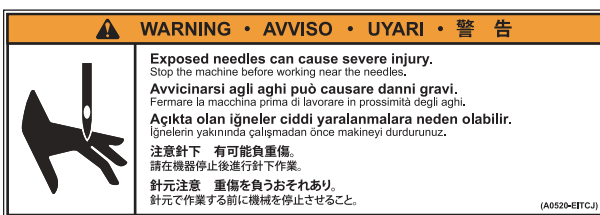

C Pay attention to rotary hook.



D High voltage indication mark



There could be danger of electric shock, burning, or death. Persons except the service personnel designated by Tajima should not open the covers.

When you open the cover, turn OFF the power switch and wait for four minutes.

E Catching mark



There could be danger of being caught or clipped. Persons except the service personnel designated by Tajima should not open the covers.

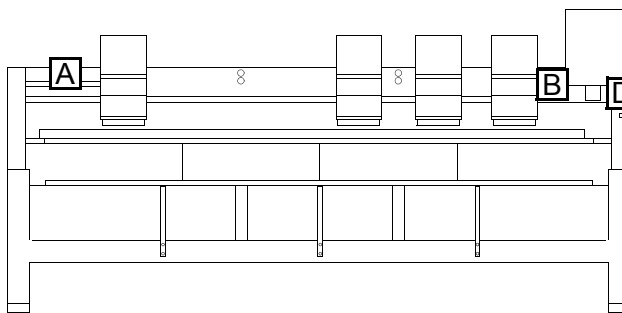

D To be affixed on the right-side box cover

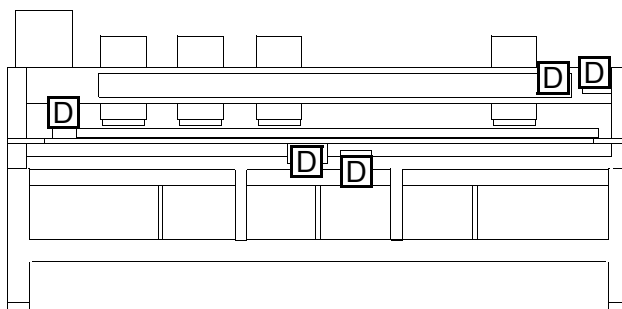

E To be affixed on the left-side box cover

[TWMX-C]

A Pay attention not to be caught into the machine.

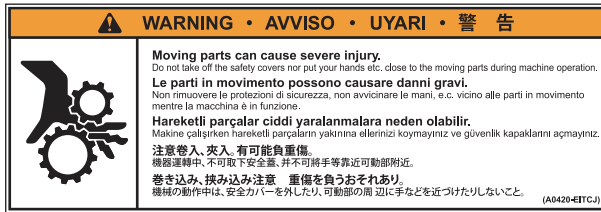

B Pay attention around needle.

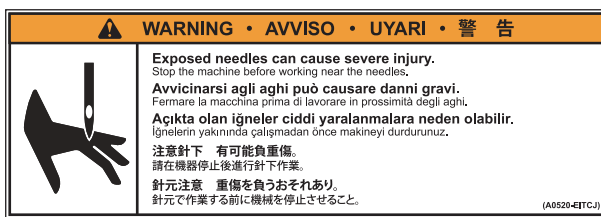

C High voltage indication mark



There could be danger of electric shock, burning, or death. Persons except the service personnel designated by Tajima should not open the covers.

When you open the cover, turn OFF the power switch and wait for four minutes.

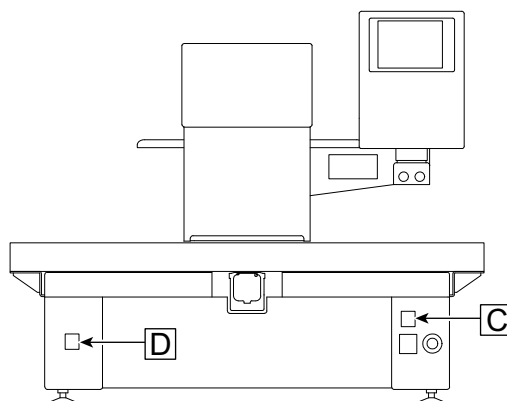
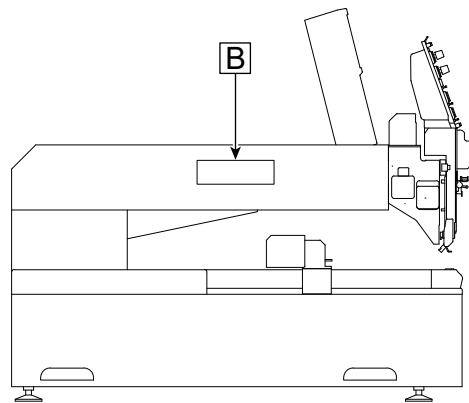
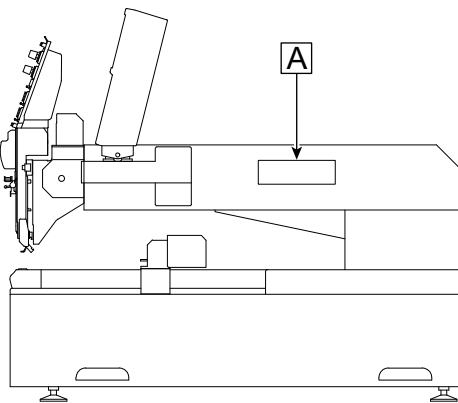

D Pay attention to rotary hook.

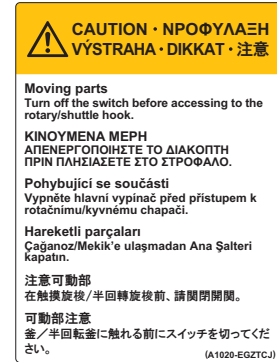

1
2
3
4
5
6
7
8
9
10
11

4. Inspection before starting work

Before starting work, execute inspection (including cleaning, lubrication) of each part.

Place	Checking
Covers	Covers might be attached incorrectly.
Upper thread	The thread might be passed incorrectly to each part. The tension might be inadequate. The thread might be entwined around frame/drive system.
Under thread	The under thread (bobbin case) might not be set to rotary hook correctly. The tension might be inadequate.
Needle	The needle might be bent. The direction of needle might have been wrong. The needle might be broken.
Rotary hook(→p.227)	Cleaning/lubrication might be performed in inadequate frequency.
Tension base switch(→p.66)	The switch of head to use might not be turned ON. The switch of unused head might not be turned OFF.
Needle bar suspension lever (→p.67)	Is the lever of head to use set to ON? Is the lever of unused head set to OFF?
Middle thread guide adjusting lever (→p.67)	Is position correct?
Jog remote-controller(→p.23)	Is it contained in the pocket?

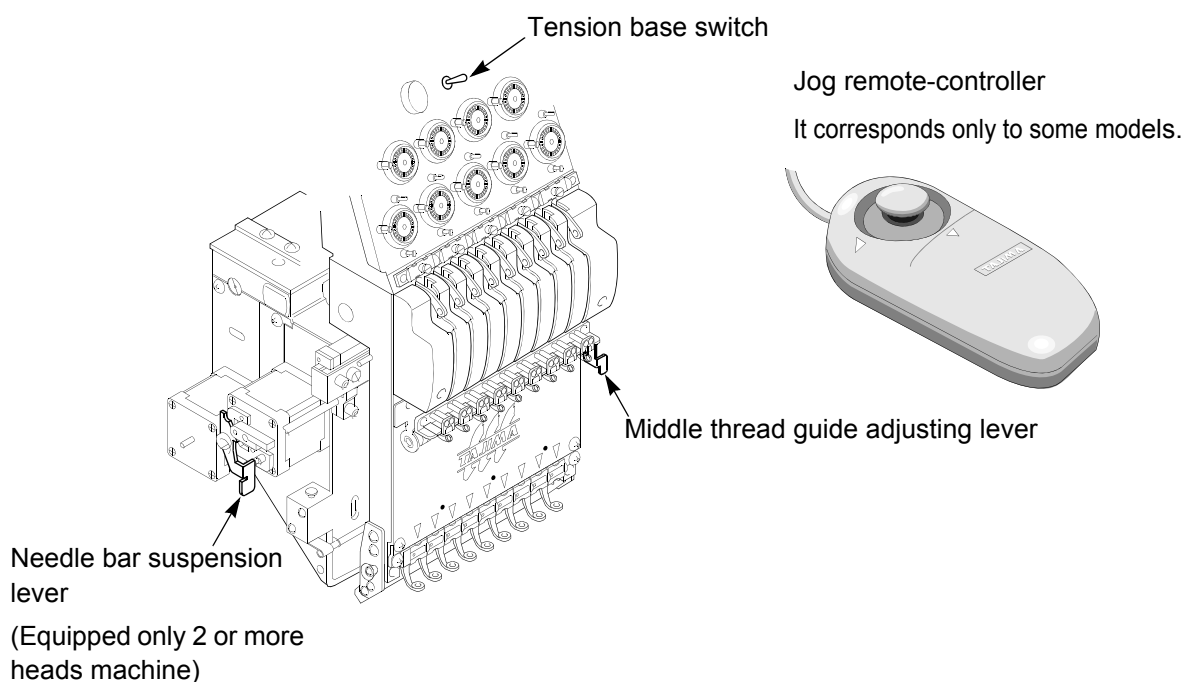

Chapter 2

Name and way to use of each part

- 1. Name of each part14
- 2. How to use each part.....18

1. Name of each part

1-1. TFMX-C single-head machine

It is described as "TFMX-C".

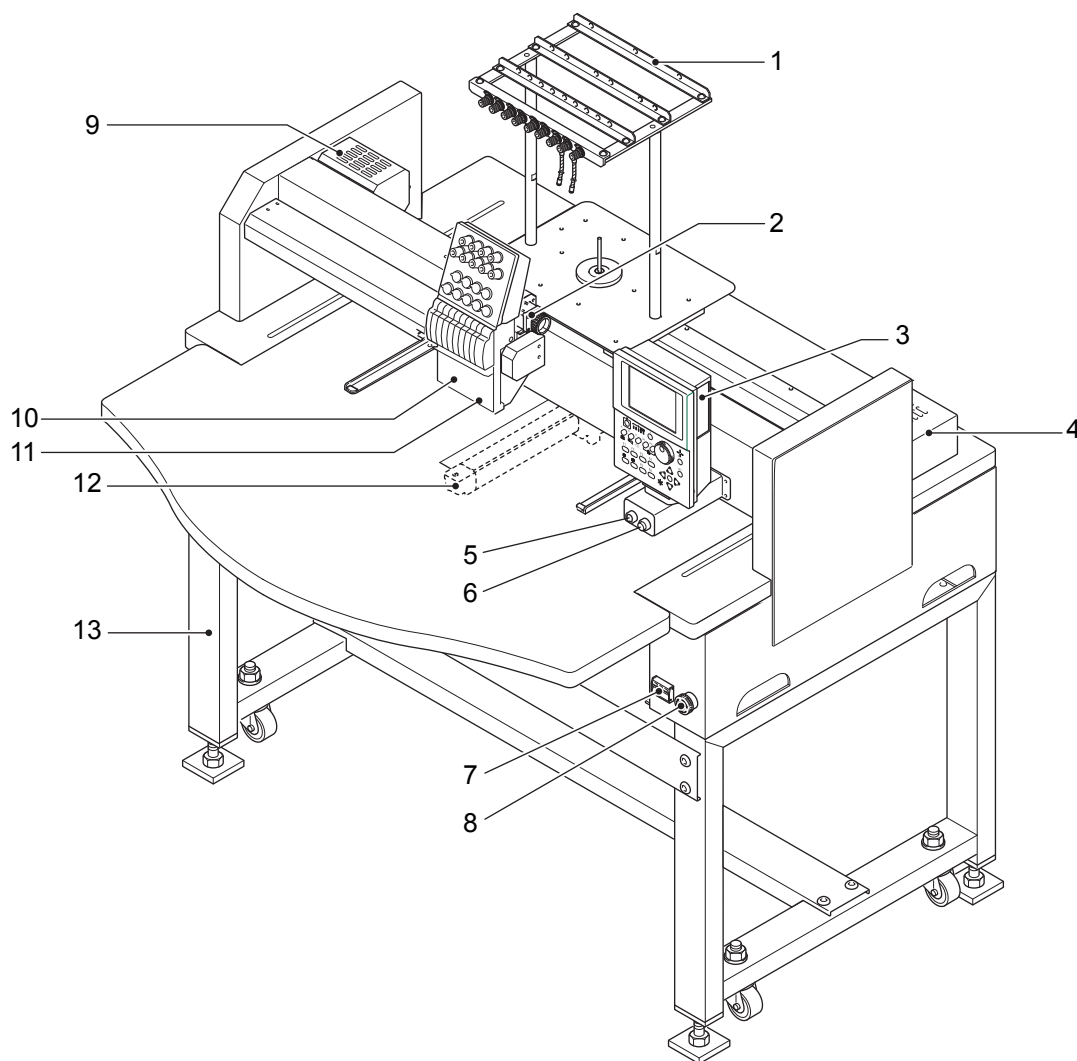

Only main sections are shown here. For details, refer to the separate parts list.

- | | |
|---------------------------|---------------------------------|
| 1. Thread course | 8. Emergency stop switch(→p.22) |
| 2. Color change system | 9. Main shaft motor |
| 3. Operation panel(→p.18) | 10. Head |
| 4. X-axis motor | 11. Needle Base LED Lamp(→p.23) |
| 5. Start switch(→p.68) | 12. Rotary hook |
| 6. Stop switch(→p.68) | 13. Stand (option) |
| 7. Power switch(→p.34) | |

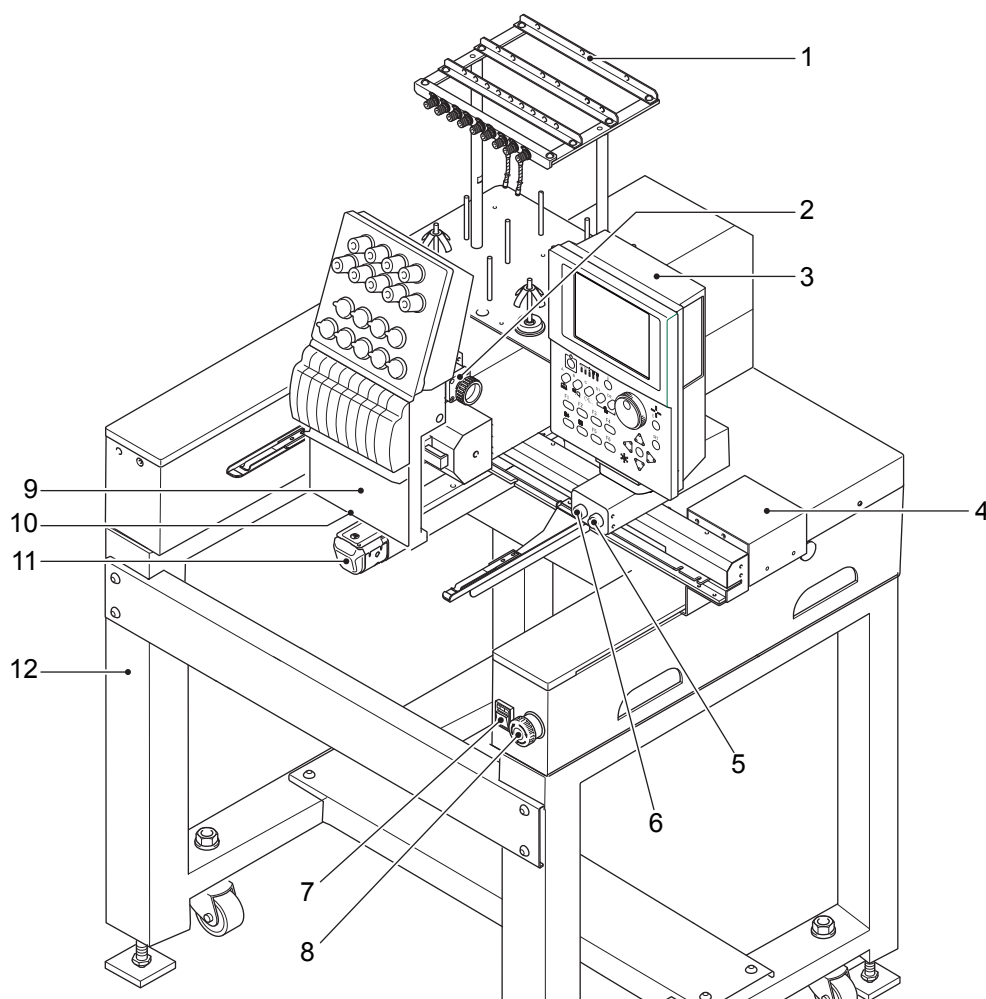
1-2. TWMX-C

Only main sections are shown here. For details, refer to the separate parts list.

1. Thread course
2. Color change system
3. Operation panel(→p.18)
4. X-axis motor
5. Stop switch(→p.68)
6. Start switch(→p.68)
7. Power switch(→p.34)
8. Emergency stop switch(→p.22)
9. Head(→p.66)
10. Needle Base LED Lamp(→p.23)
11. Rotary hook
12. Stand (option)

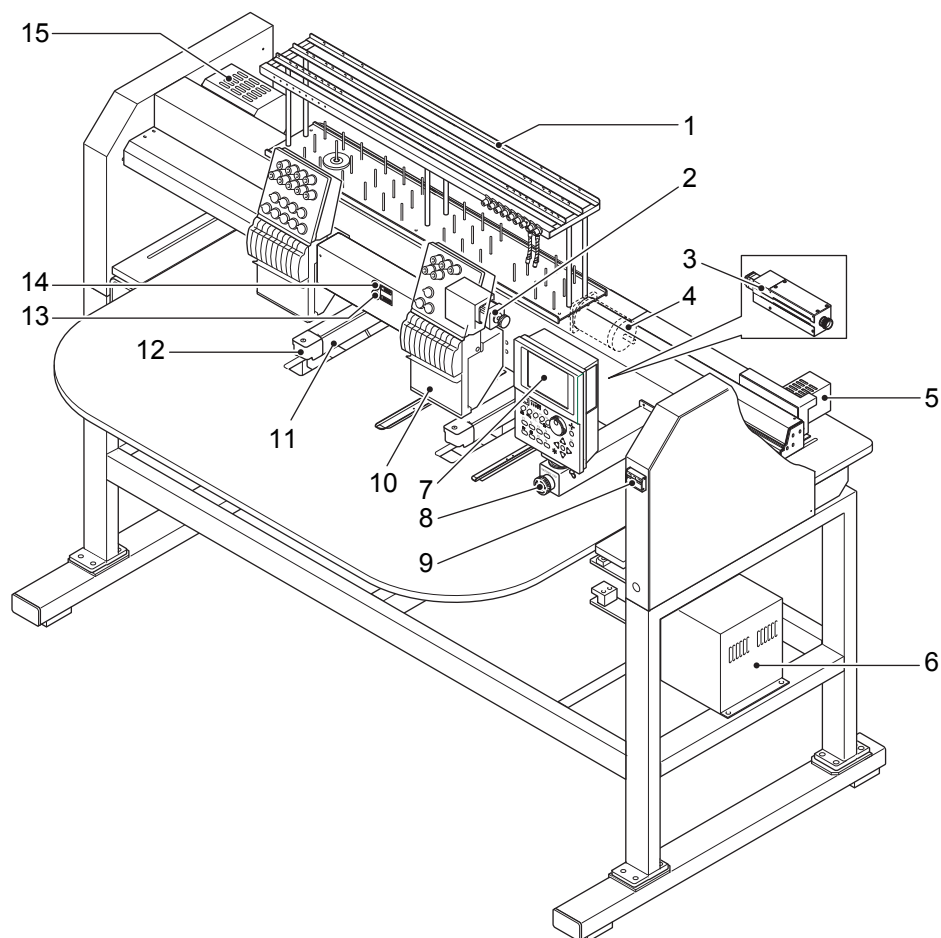
1-3. TFMX-IIC TYPE-2

Only main sections are shown here. For details, refer to the separate parts list.

- | | | |
|--|---------------|-------------------------|
| 1. Thread course | | 9. Power switch(→p.34) |
| 2. Change unit A | ↔ Alternative | 10. Head(→p.66) |
| 3. Change unit B | | 11. Slim cylinder bed |
| 4. Y-axis motor | | 12. Rotary hook |
| 5. X-axis motor | | 13. Stop switch(→p.68) |
| 6. Transformer | | 14. Start switch(→p.68) |
| | | 15. Main shaft motor |
| Existence/absence differs depending on spec. | | |
| 7. Operation panel(→p.18) | | |
| 8. Emergency stop switch(→p.22) | | |

1-4. TFMX (L)

It may be described as "L-spec. machine" in this manual.

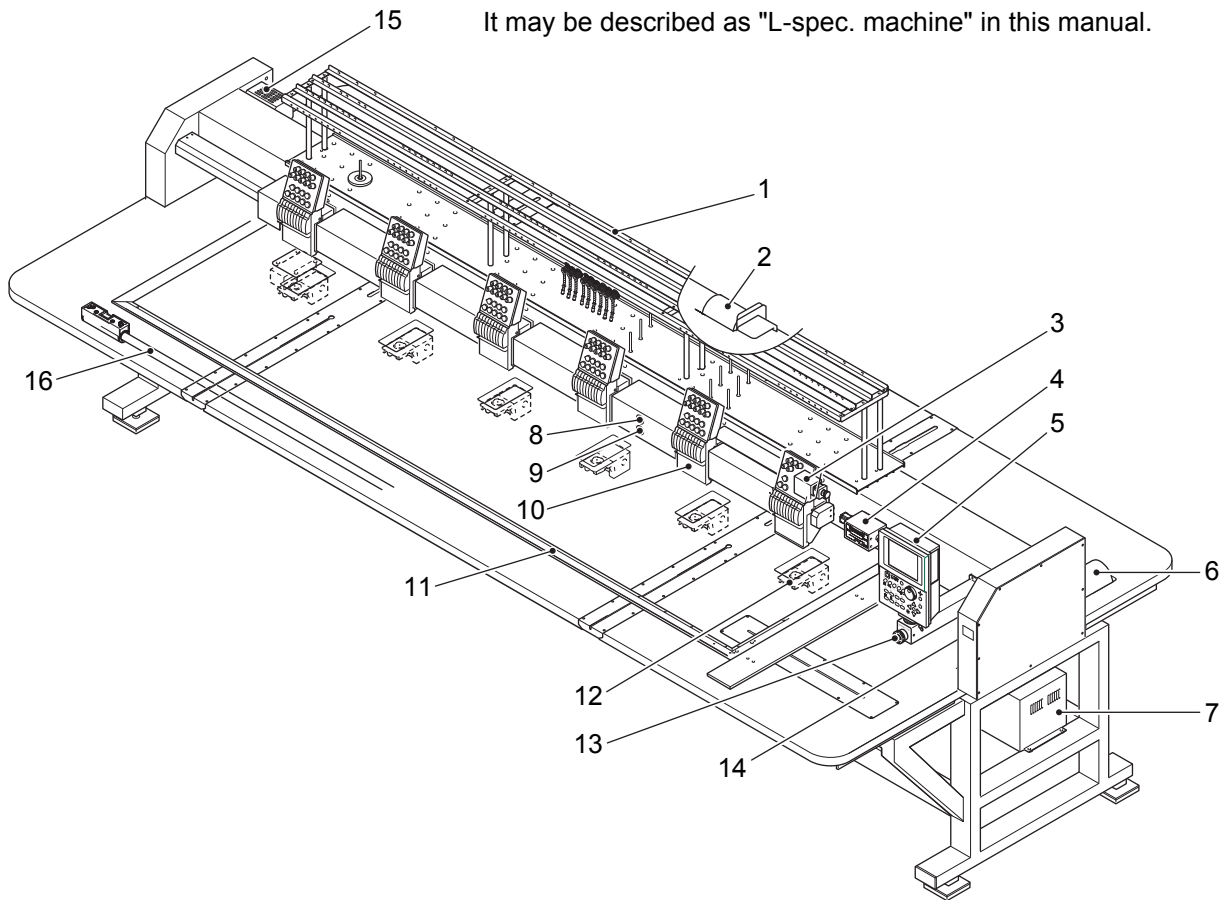

Only main sections are shown here. For details, refer to the separate parts list.

- | | |
|--|----------------------------------|
| 1. Thread course | 8. Stop switch(→p.68) |
| 2. Main shaft motor | 9. Start switch(→p.68) |
| 3. Change unit A | Alternative |
| 4. Change unit B | |
| 5. Operation panel(→p.18) | 10. Head(→p.66) |
| 6. X-axis motor | 11. Border frame |
| 7. Transformer | 12. Rotary hook |
| Existence/absence differs depending on spec. | 13. Emergency stop switch(→p.22) |
| | 14. Power switch(→p.34) |
| | 15. Main shaft motor |
| | 16. Bar switch(→p.69) |

2. How to use each part

2-1. Operation panel

2-1-1. Front

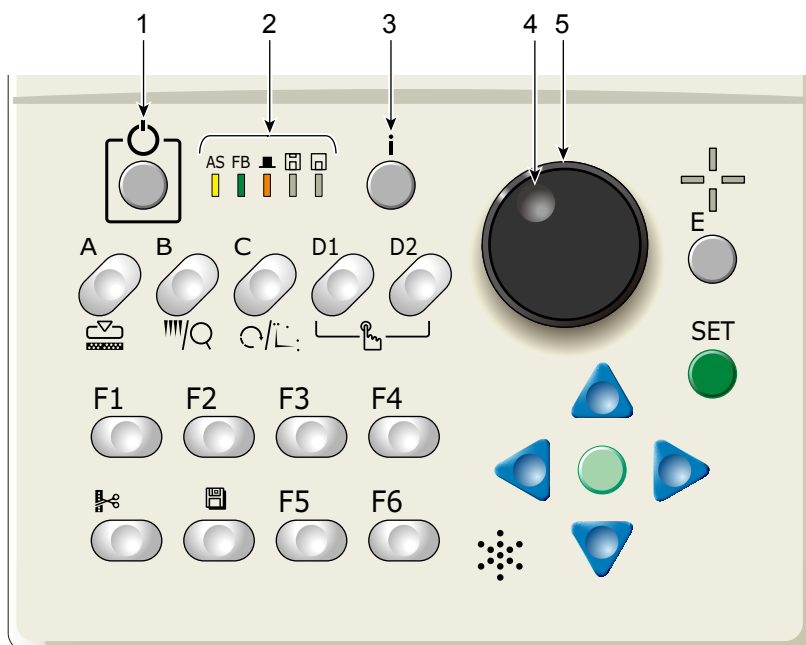

1. Sleep mode key(→p.22)

Switch to power save mode. To release, press this key again.

2. Condition of the machine

AS (Auto Start)

To perform: Lit

Not to perform: Unlit

FB (frame back / foward)(→p.69)

Frame Back: Lit

Frame Forward: Unlit

■(Main shaft stop position)

Fixed position: Lit (normal)

Other than the fixed position: Unlit (abnormal)

Lower dead point, or main shaft brake "NO": Blinking

□(FDD)

Not used currently

□(USB port)

During operation: Lit

3. Design confirming mode key (i key in this manual) (→p.29)

It is possible to check the detail of the design to be embroidered from now.

4. Jog dial

Move the frame at low speed.

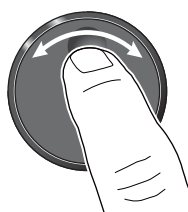

It is illustrated as below in this manual.

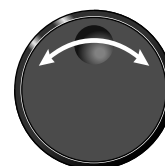

5. Jog shuttle

Move the frame at high speed.

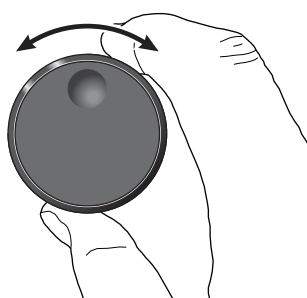

It is illustrated as below in this manual.

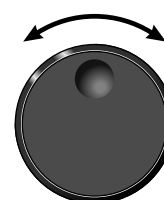

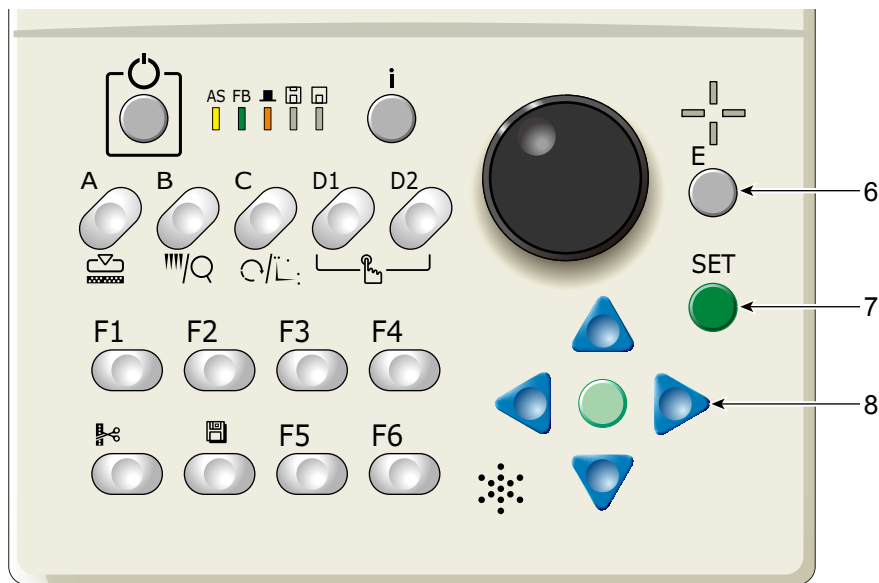

6. Escape key (E key in this manual)

The screen will return to the original screen.
Release the stop factor.

Frame travel direction will be selected at Frame Travel by using the the jog dial or the jog shuttle.
(→p.60)

7. Set key

Determine the selected value.

8. Frame Travel key(→p.60)

Move the frame manually.

2-1-2. Side

(1) USB port

Two USB ports are located at the side face of the right-side of the machine. Use the USB port for the following purpose.

- When connecting the USB memory
- When connecting the bar code reader (commercial item)

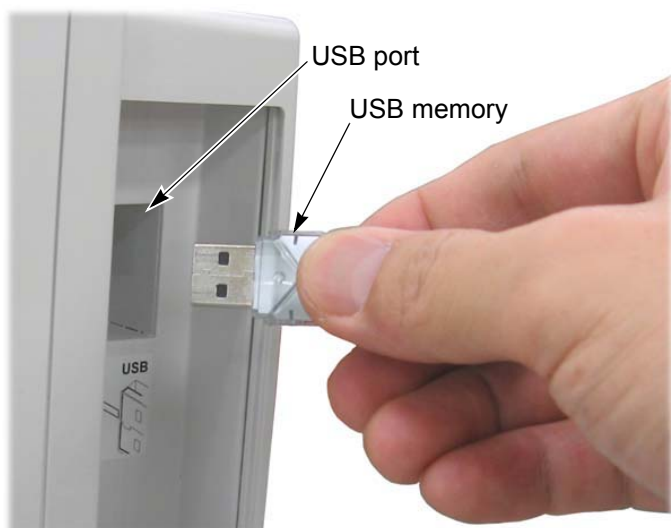

(2) USB memory

Prepare a commercial item. USB memory is used for the following cases.

When registering the design (saved in the USB memory) into the machine memory

When saving the design (saved in the machine memory) into the USB memory

When installing the software in the machine

Some type and/or capacity of the USB memory could not be used for this machine. In this case, buy the USB memory recommended by Tajima. For details, consult the distributor.

For using the USB memory, observe the items to notice described below.

CAUTION

- ⊘** When you insert the USB memory, do not mistake the direction of connector. The USB memory and its inside card could be damaged.
- ⊘** Do not insert the USB memory into the connector in the state that dirt and dust are attached to the inside of the connector.
- !** Insert a USB memory slowly and gently.
- !** Insert a USB memory upright against the port (insert slot). Oblique insertion could damage to inside card due to interference of connector with the card.
- !** Wait for five or more seconds after inserting or taking out a USB memory, and then start operation. It may take about one minute at a maximum to recognize data.

2-1-3. Rear**(1) LAN port**

Use the LAN port when connecting the LAN cables.

(2) LAN cable

Please prepare a commercial item. LAN cable is used for connecting a personal computer with the machine. Setting of the operation panel is necessary additionally. (→p.193)

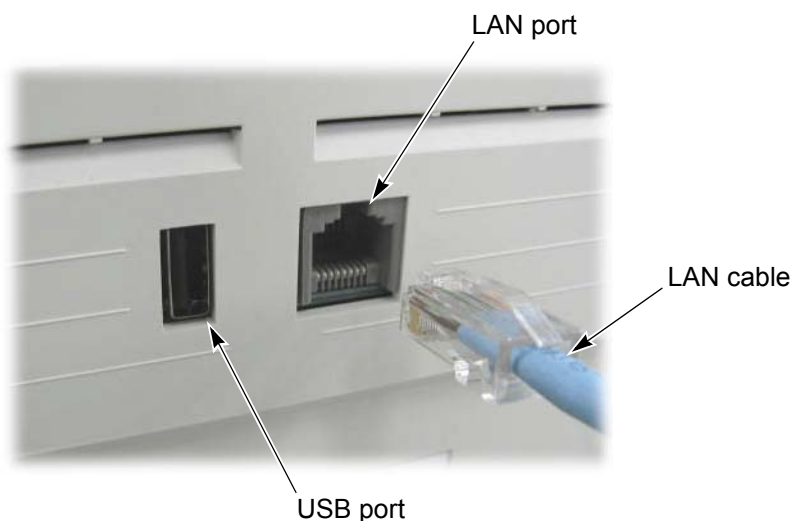

2-2. Sleep mode key

Setting the machine to sleep mode at intermission etc. will suppress unnecessary power consumption.

2-2-1. How to switch to the sleep mode

- (1) Set to the main screen.
- (2) Press the sleep mode key for a few seconds. The sleep mode key is blinking in red.

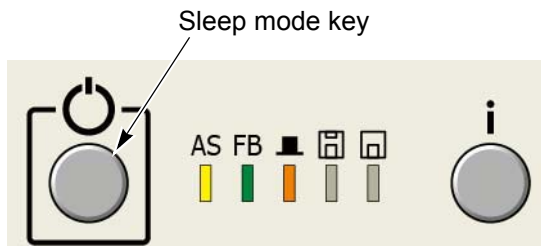

2-2-2. How to cancel the sleep mode

CAUTION

 When performing this operation, do not put your hands etc. on the machine table. Moving frame could injure you.

Press the sleep mode key. The sleep mode key will be unlit. (Cancellation will be completed.)

When the following message will be displayed after the cancellation, press the SET key. Pressing SET key will move the frame to the origin and then return to the previous position.

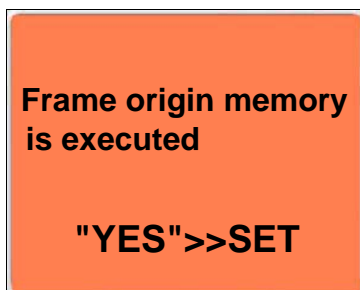

This message will not be displayed in L-spec. machine.

It is displayed only when "Frame origin memory with the power ON" is set to "YES".(→p.160)

Regarding "Frame origin memory", refer to the detail page. (→p.159)

2-3. Emergency stop switch

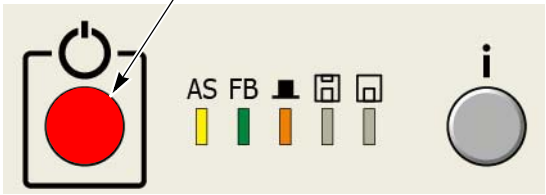

The emergency stop switch is equipped as a measure for safety. Pressing this switch will stop the machine. Since the switch is in the locked state, release it according to the following procedure. After releasing, the operation can be started as usual.

Specification of the machine	Condition after stop	How to release
EN-spec. (European safety spec.)	The power will be turned OFF.	<p>(1) Turn the switch clockwise. (The power will be turned ON.)</p> <p>(2) Start the operation.</p>
Excluding EN-spec., and Japanese domestic use	The machine will switch to the sleep mode.	<p>(1) Turn the switch clockwise.</p> <p>(2) Press the sleep mode key.</p> <div style="text-align: center;">  <p>Sleep mode key</p> </div> <p>It takes a while until the sleep mode is released.</p> <p>(3) Start the operation.</p>

2-4. Needle Base LED Lamp

Needle Base LED Lamp is equipped to TFMX-C, TWMX-C. It is possible to turn ON/OFF Needle Base LED Lamp by the switch

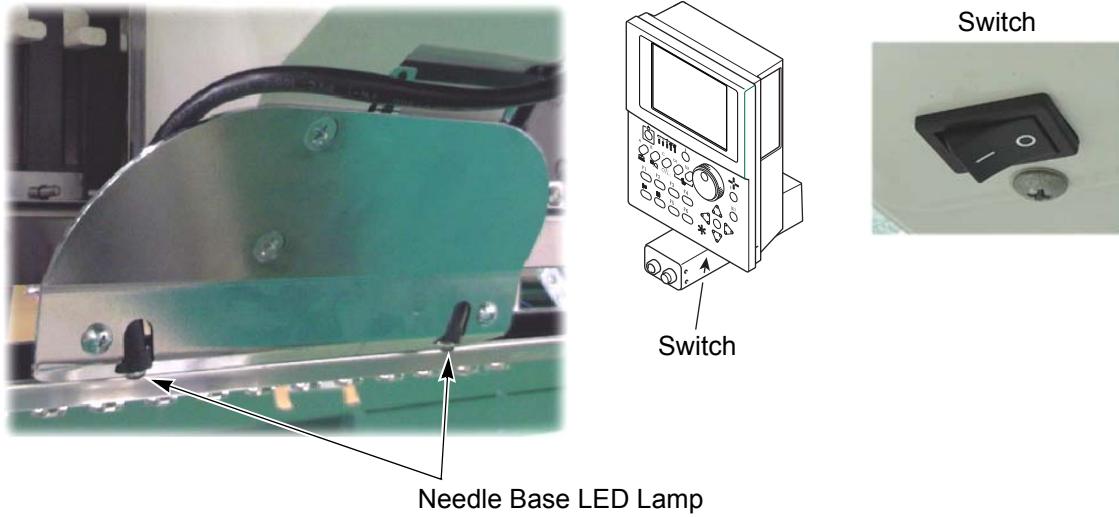

2-5. Jog remote-controller (Option for some models)

This is a device to move the frame manually. Regarding how to use, refer to the detail page.(→p.61)

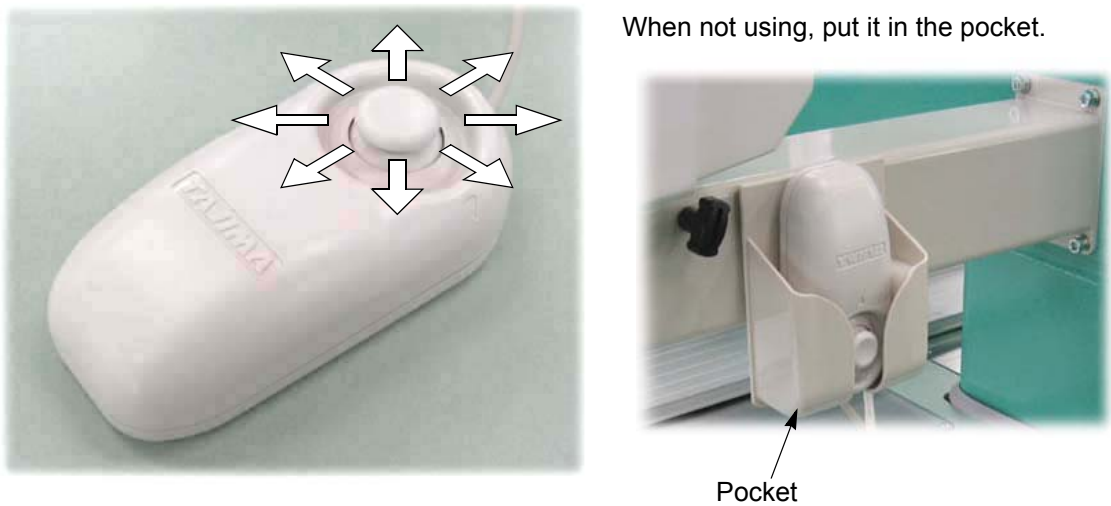

2-6. Table offset switch

This operation facilitates threading by moving the frame to the rear (the table offset position) at thread breakage. Pressing this switch will move the frame to the table offset position. This function is supported by the machine equipped with the table offset switch.



Table offset switch

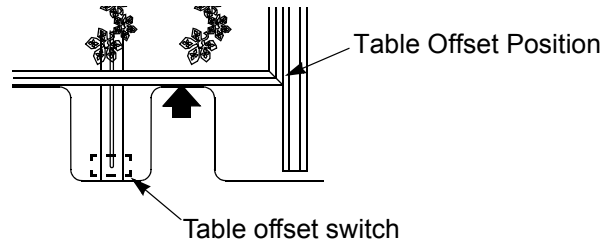

When changing table offset position, refer to the detail page. (→p.169)

2-6-1. How to operate

CAUTION

 When performing this operation, do not put your hands etc. on the machine table. Moving frame could injure you.

The machine stops when thread breaks. Since the movement of the machine differs depending on the switch operation, perform any one of the following operations. The frame moves in the same way even when the thread does not break.

(1) Press the switch and release it immediately.

→ The frame will move to the rear.

(2) Press the switch for two seconds or more.

→After trimming threads of all heads, the frame will move to the rear.

Since the movement of the machine after passing the thread differs depending on the switch operation, perform any one of the following operations.

(1) Press the switch and release it immediately.

→ The frame will return to the original position.

(2) Press the start switch, or move the bar switch to the right.

→ The frame will return to the original position and the operation will be started.

(3) Press the stop switch or move the bar switch to the left.

→ The frame will return to the original position and the machine will perform frame back/forward.

(→p.69)

Chapter 3

Screen

1. Screen display	26
2. Message display	31

1. Screen display

1-1. Main screen

When the power is turned ON, the following screen will appear. From this screen, setting/operation to embroider will start. To return to the main screen from other screen, press E key until the main screen appears.

1-1-1. Screen

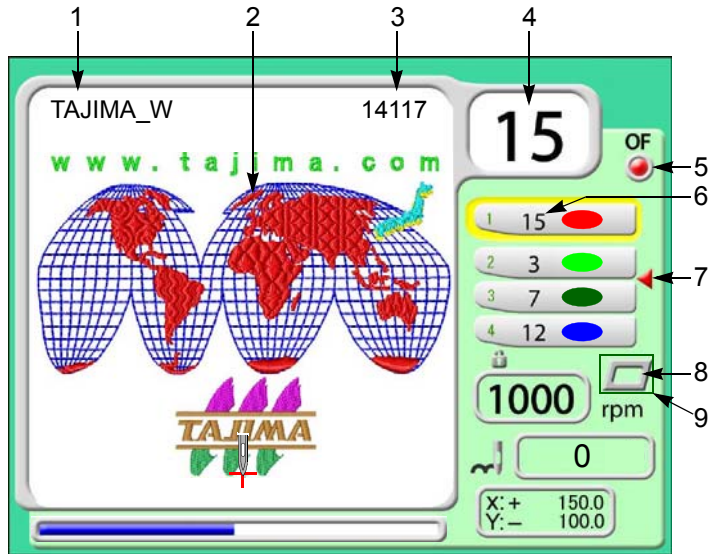

1. Design name
2. Design (data set design) to be embroidered from now
3. Total stitch number of design
4. Current needle bar No.
5. Setting of Automatic Offset(→p.164)
 : With, : Without
6. Needle bar No. selected in each step (→p.53)
7. Setting to return the frame to the front during embroidery (→p.166)
 : With setting
8. Current set frame
9. Software Frame Limit(→p.93)
 : With setting

At cap frame spec., setting "Design rotation by 180 degree" to "YES" will rotate the design by 180 degree.(→p.155)



- / W Tubular W: TWMX-C
- / W Border frame
- / X-EXT XExtension unit
- Cap frame
- Frame holder
- Cylindrical frame
- Tubular goods auto clamp frame
- Border frame auto clamp frame

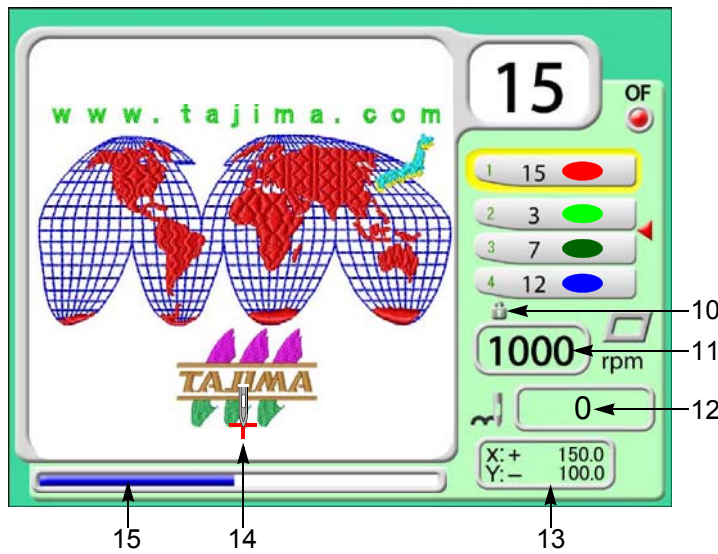

10. R.P.M. limit for each design

When R.P.M. limit value is written for the design (****.TCF), the padlock icon will be displayed.

To write the revolution limit value in the design(****.TCF), DG/ML by Pulse is necessary.

The lock icon will be displayed after design input (described below).

LAN input (except Sidekick)

Design input by using USB memory

Data set of the machine memory design

11. Maximum speed(→p.64)

During stop

The current set maximum speed will be displayed.

During operation

The actual embroidery speed will be displayed.

12. Current number of stitches

13. Current frame position (mm)

14. Start point of design

15. Completed ratio of embroidery

1
2
3
4
5
6
7
8
9
10
11

1-2. List screen

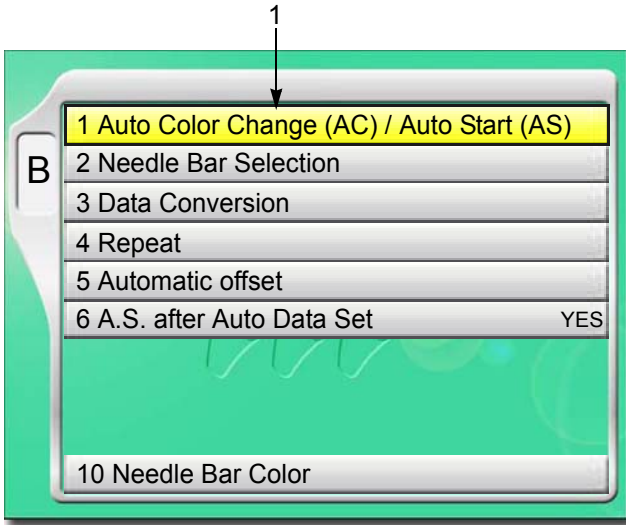

The screen shown left will be displayed if B key is pressed.

1. Cursor

Selected item will be displayed in yellow.

To lower the cursor, press B key or ▼

Pressing [SET] will switch to "Setting screen".

1-3. Setting screen

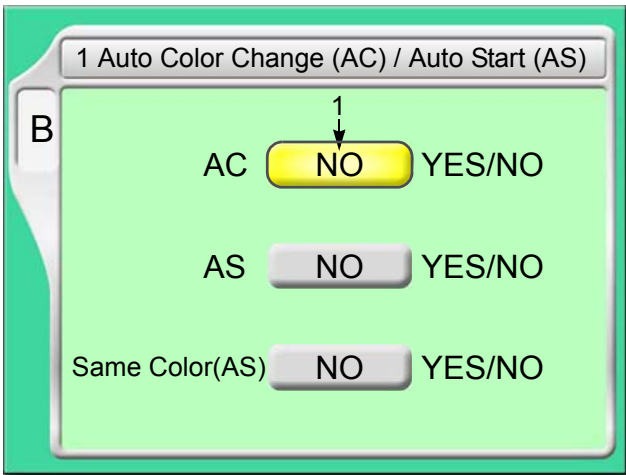

1. Select YES/NO by using the jog dial and press SET key.

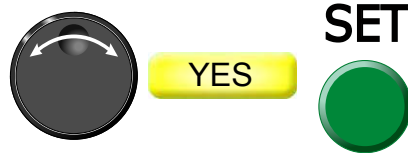

To lower the cursor, press set key or ▼

To return the screen, press E key.

1-4. Character/numeric value input screen

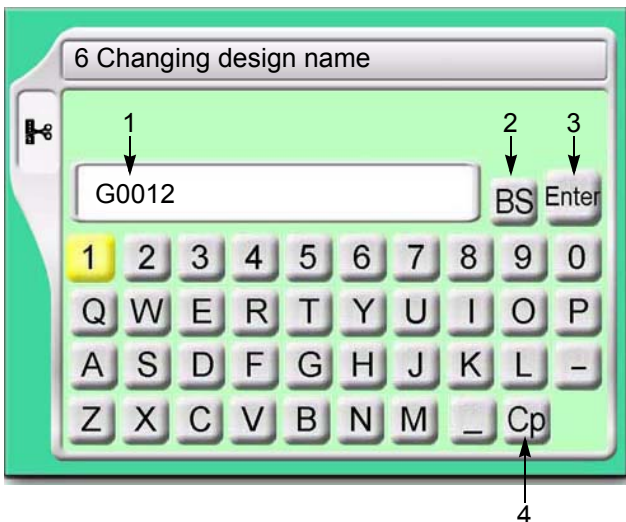

1. File name (up to 8 characters)
2. Return the cursor or delete the character.
3. Determine the input character and numeric value.
4. Switching of large letter/small letter

[How to input]

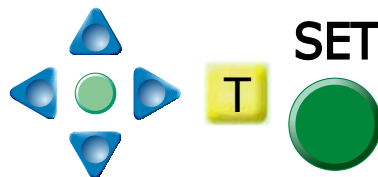

After finishing input, press Enter and SET key.

1-5. Design confirmation screen

It is possible to check the setting content of the design to embroider from now and the occurrence record of stop factors (Error Stack).

To switch to the design confirmation screen, press i key.

Pressing again i key will switch to the next screen.

To return to the original screen, press E key.

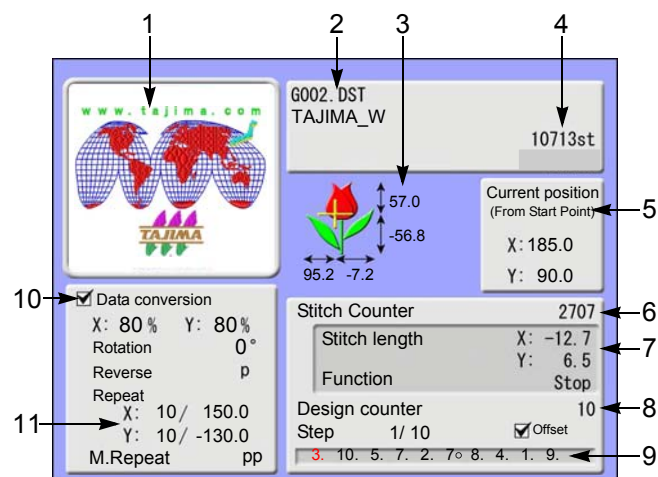
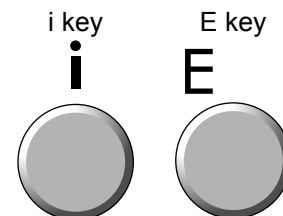

1. Design (data set design) to be embroidered from now
2. File name
3. Design size
+ : Design Start Point (starting position of design)
4. Total stitch number of design
5. Current frame position
Distance from design start point
6. Current number of stitches
7. Current stitch contents
8. Number of times of embroidering this design continuously
9. Step(→p.53)

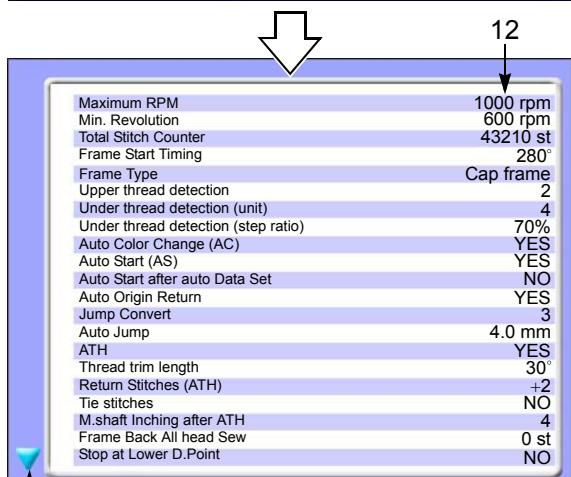
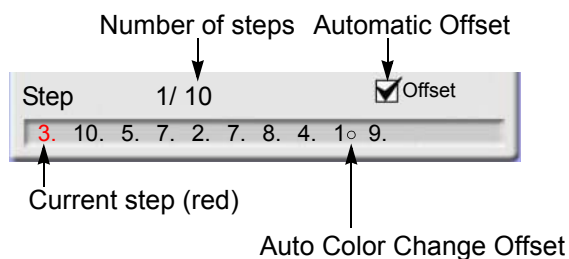

10. Scaling up/down/reversion of design
11. Design repetition
12. Current setting contents
13. It indicates the next page exists.

Pressing key will scroll the page.

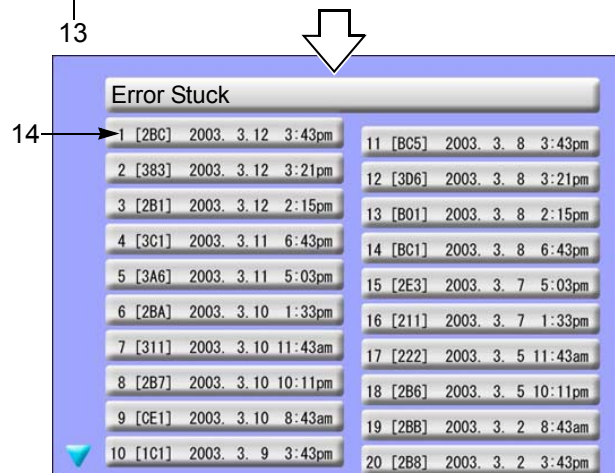

14. Stop factor occurred at last(→p.214)

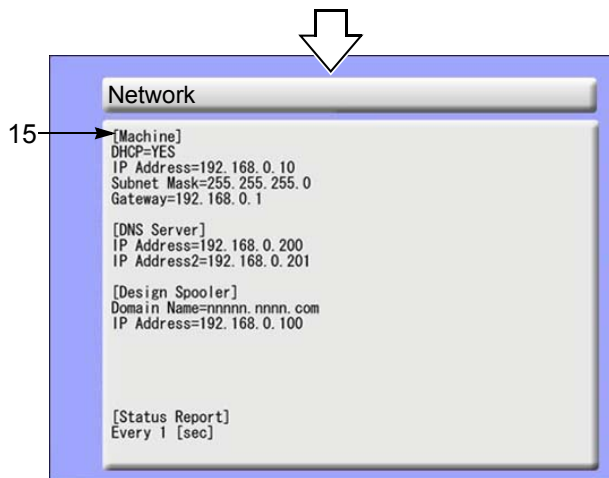

15. Network information

The screen shown left will be displayed even if Network is set to "NO". Contents of display differ depending on individual environment.

2. Message display

2-1. Condition data

When registering the design (saving format is T3, or T2 design) saved in the USB memory into the machine memory, the following message will appear.

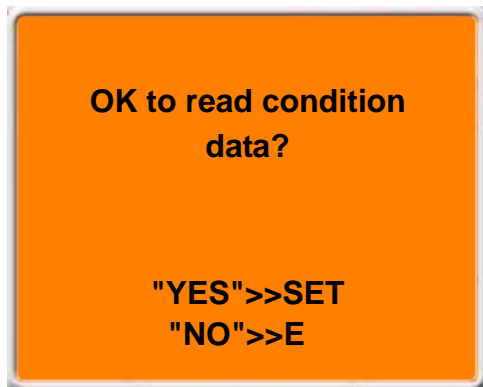

Condition data means the following two items in this case.

- (1) Color change sequence
The whole color change sequence included in the design can be registered into the machine memory. Therefore, it is unnecessary to set it again.
- (2) Start point of design
The frame position where the machine started embroidering last time can be registered in the machine memory. Therefore, it is unnecessary to adjust the position of the frame.

There are following three items of condition data except the one described above. By setting them after data set, each setting contents will be added in a design. Therefore, it is unnecessary to perform setting again when you embroider this design next time.

- (1) Scaling up/down/reversion of design
- (2) Design repetition
- (3) Automatic Offset

2-1-1. When reading the design (Example: TAJIMA_W) saved in the USB memory by a personal computer

Indications in a personal computer are different as shown in the chart below depending on the saving format (T3, T2, T) of the design.

Saving format	Indication in personal computer	Use
T3	TAJIMA_W.TCF	Data integrating CT0, DGF and TBF of T2
T2	TAJIMA_W.CT0	Color change sequence, design start point
	TAJIMA_W.DGF	Redeced-size design data (Thumbnail)
	TAJIMA_W.TBF	Stitch data of TAJIMA binary format
T	TAJIMA_W.DST	Stitch data of TAJIMA ternary format

[About T2]

One design consists of three types of file (TAJIMA_W.CT0, TAJIMA_W.DGF, TAJIMA_W.TBF).

2-1-2. Saving or reading of condition data

Condition data can be saved or cannot be saved depending on its place to save.

O: Can be saved / X : Unable to save

Condition data	Saving into machine memory	Saving into USB memory		Saving from DG/ML by Pulse into the machine memory
		T3, T2	T	
1. Color change sequence	O	O	X	O
2. Start point of design	O	O ^[*1]	X	O
3. Data Conversion ^[*2]	O	X	X	X
4. Repeat of design	O	X	X	X
5. Automatic Offset	O	X	X	X

*1: When embroidering the design between models with different embroidery spaces, the start position of the design may differ depending on the model.

*2: Scaling up/down/rotation/reversion of design

2-2. Start point of design

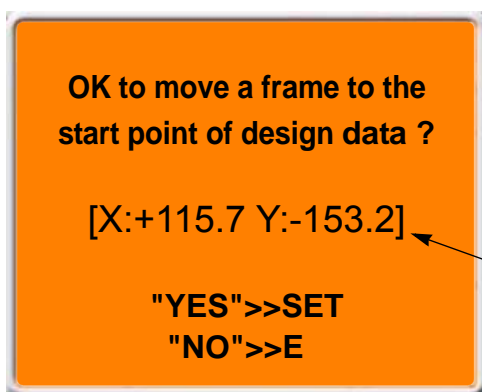

The message shown left will be displayed only when the machine reads condition data at "2-1."

This message is displayed when performing data set. Design start position means the frame position where the embroidery of this design was started last time.

These figures mean the destination of moving the frame. Frame coordinates are shown.

2-3. Offset Return

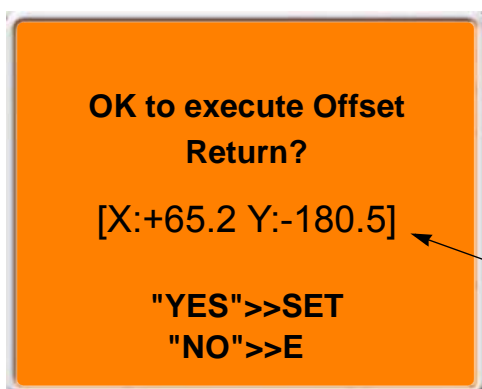

The message shown left will be displayed only when the machine has the setting of "Automatic offset".

This message is displayed when performing data set. Offset return means the offset start position where this design was embroidered last time.

These figures mean the destination of moving the frame. Frame coordinates are shown.

Chapter 4

How to perform embroidery

1. To turn ON the power.....	34
2. Thread passing, fabric setting.....	37
3. Registration of a design into the machine memory.....	41
4. Decision of an embroidery design and the color change sequence	50
5. Decision of the design start position	57
6. Check items before embroidering	64
7. Embroidery starts.....	68

1. To turn ON the power

! CAUTION	
<p>⊘ Do not turn ON the machine power in the state that the USB memory is connected to the operation panel except when installing the software in the machine. The system sometimes may not start up.</p>	

1-1. Power switch

There are following types of the power switch depending on the model.

1-1-1. TFMX-C, TWMX-C

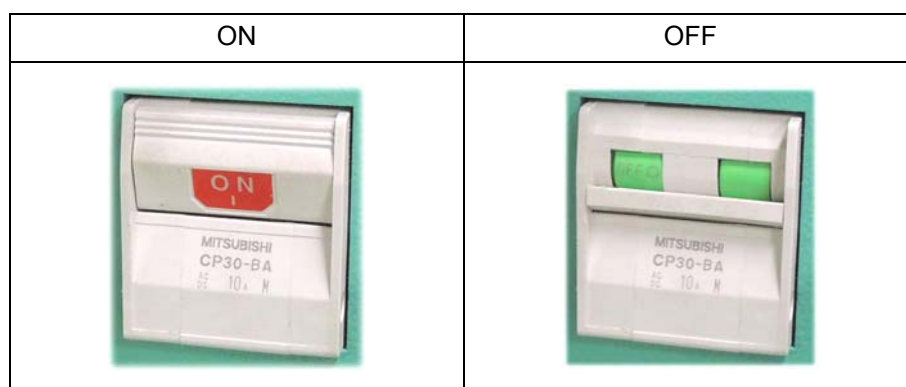

1-1-2. TFMX-IIC TYPE-2

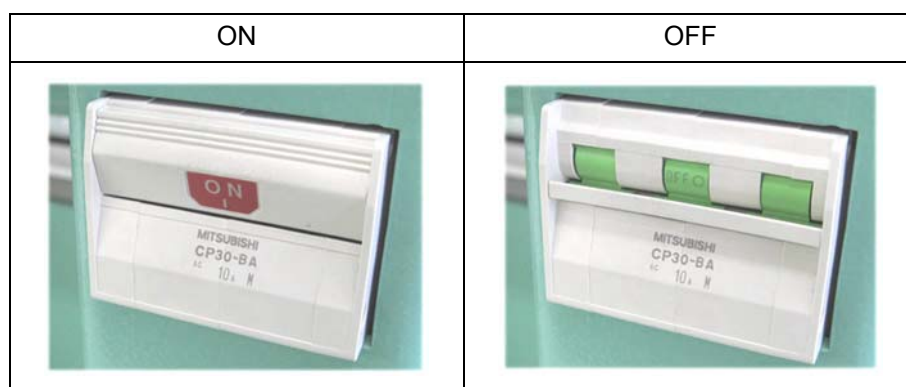

1-1-3. Some spec. of TFMX-IIC TYPE-2, TFMX(L)

This type can be locked.

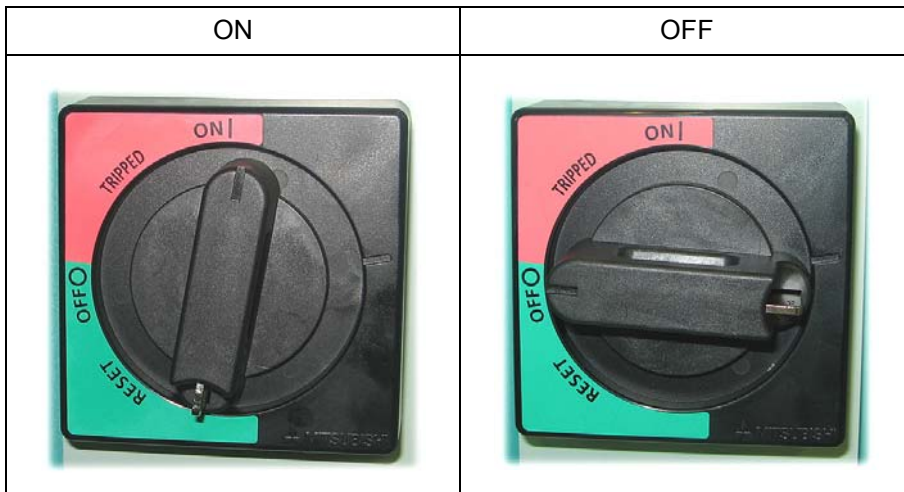

[When locking]

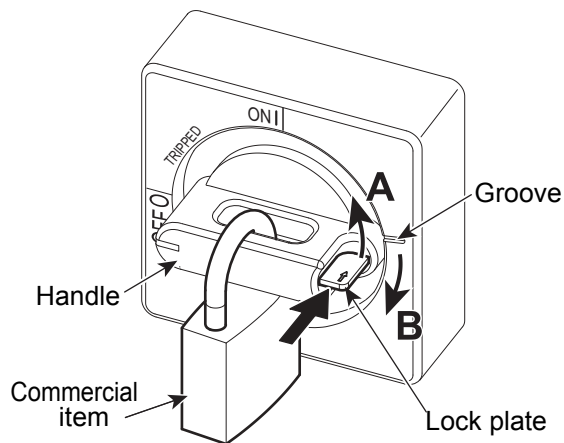

- (1) Turn the handle toward direction A to the position of the groove.
- (2) Push the lock plate to the direction indicated by a big arrow and return the handle to the direction B (the original position).
- (3) Lock.

1
2
3
4
5
6
7
8
9
10
11

1-2. To turn ON the power

- (1) After turning on the power, the screen will switch as the figure below. Wait for a while until the power starts up.

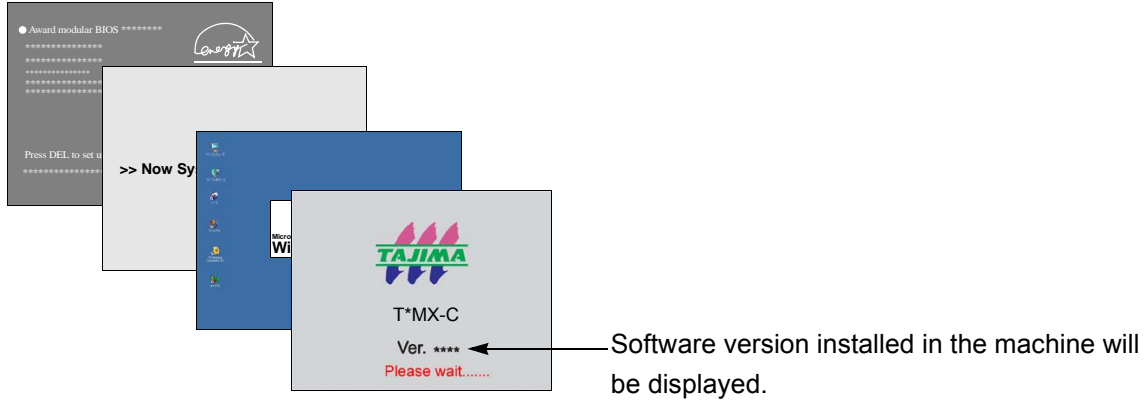

- (2) When the power starts up, the following message will appear. Then, press SET (this message will not be displayed in L-spec. machine).

CAUTION

When performing this operation, do not put your hands etc. on the machine table. Moving frame could injure you.

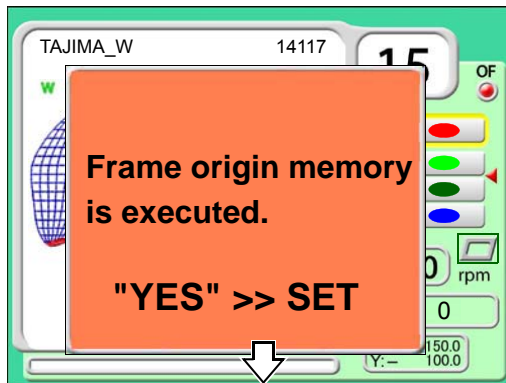

This operation is to grasp accurately the frame position and it is displayed every time when the power is turned ON.

This message will be displayed only when "Frame Origin Memory with the power-ON" is set to "YES". (→p.160)

When you do not want to display this message, set to "NO".

SET Press SET.



The frame will move and return to the original position.

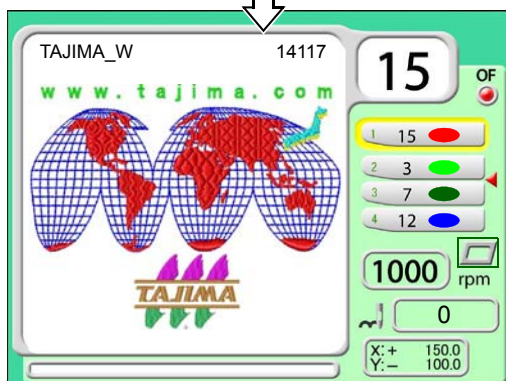

Main screen

2. Thread passing, fabric setting

2-1. Thread passing

If the thread does not pass to each section correctly, it could cause trouble such as the deterioration of embroidery or the thread breakage, etc. Pass the thread correctly referring to the figure below.

- (1) Place the thread cone on the thread stand blade.
- (2) Pass the thread through the thread course.

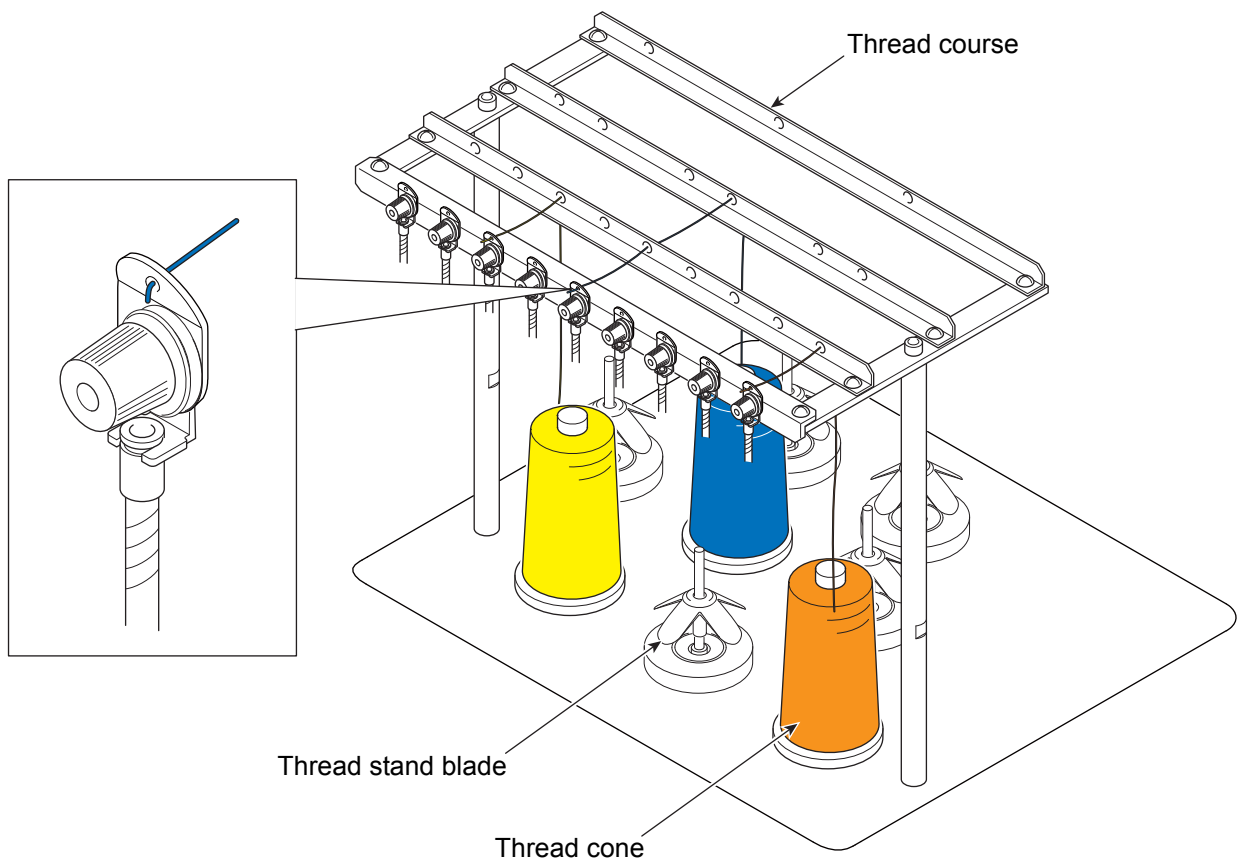

1

2

3

4

5

6

7

8

9

10

11

- (3) Put the thread into the groove of the tension stud. (Indicated by an arrow)
- (4) To perform threading through the spiral tube, use the threader (accessory).

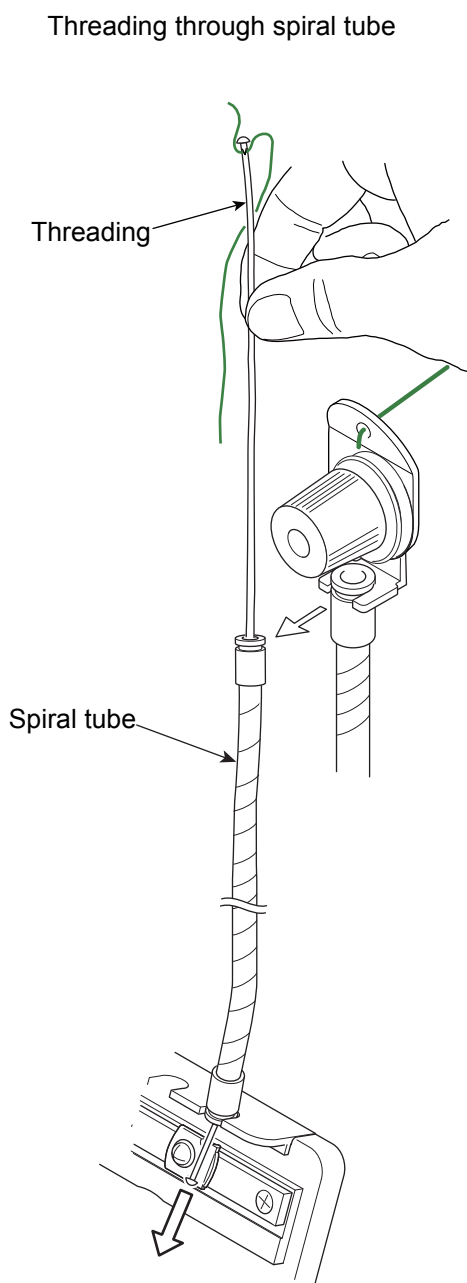
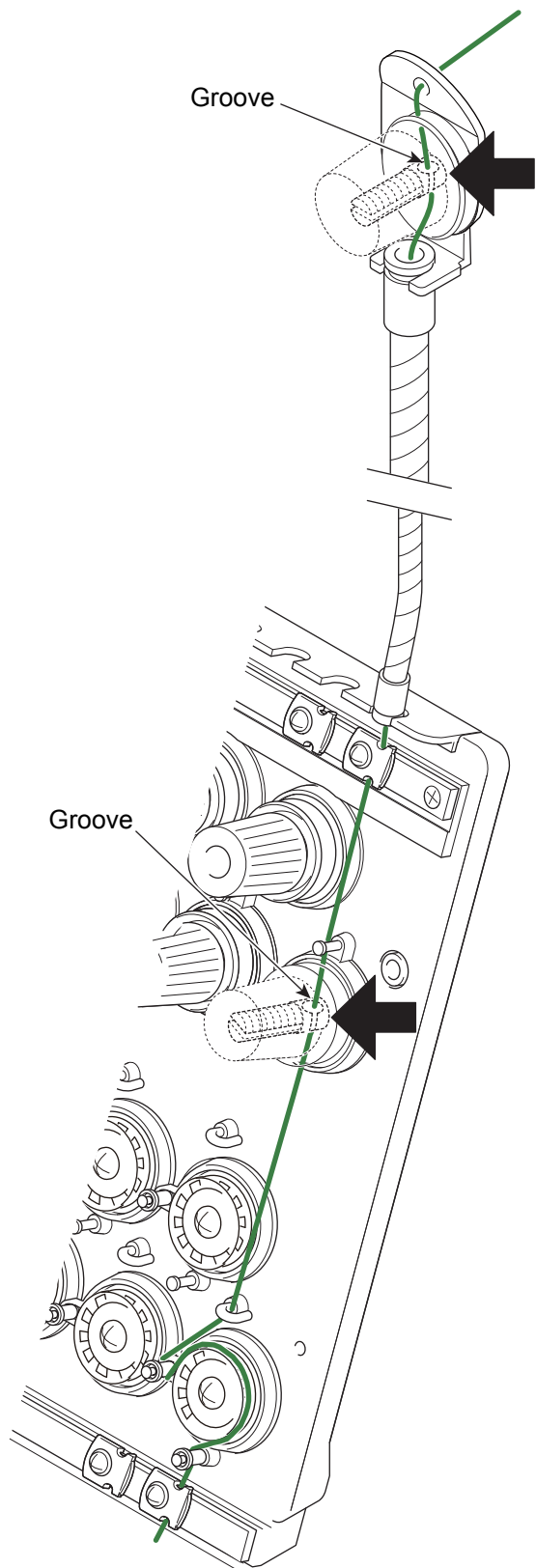

! CAUTION

- !** Pass the thread to the thread take-up spring and the upper thread lock surely. Otherwise, thread breakage would be caused or the thread tension would be affected badly.
- !** Return the adjusting lever to the original position after passing the thread. Otherwise, thread breakage would be caused or the thread tension would be affected badly.

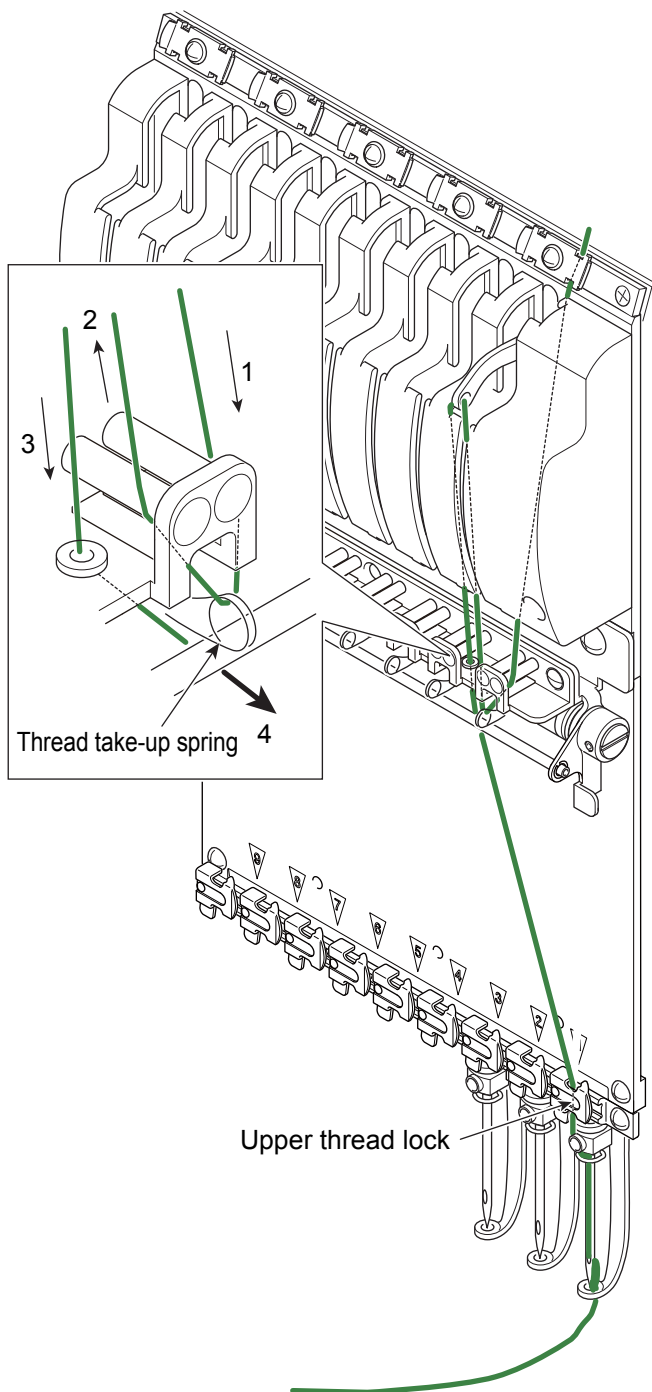

How to use adjusting lever

(1) Raise the lever.

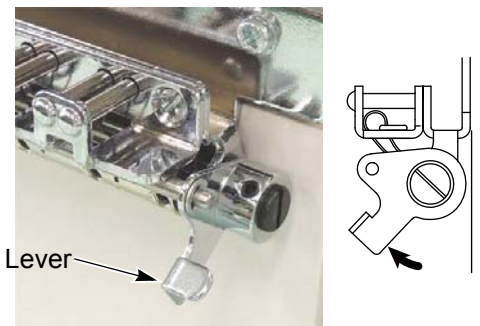

(2) Thread passing

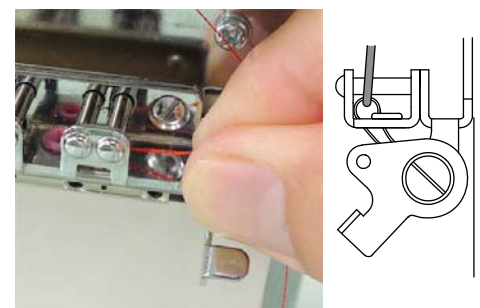

(3) After threading, return the lever. (The screw should face the front.)

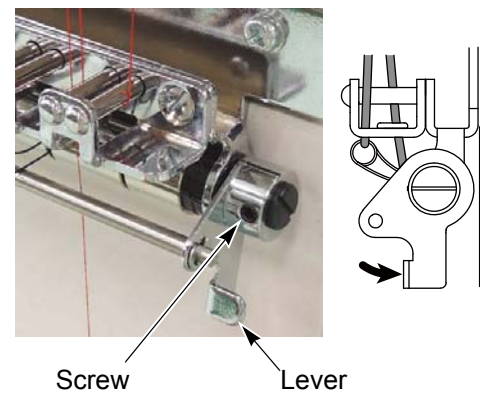

1
2
3
4
5
6
7
8
9
10
11

2-2. To set fabric to embroidery frame

To make embroidery results beautiful or to perform efficient works by reducing the thread breakage, it is important to stretch the fabric correctly on the embroidery frame. Fix fully stretched fabric without any wrinkle.



Regarding how to stretch the fabric and replace the embroidery frame, refer to the separate manual "FRAME REPLACEMENT".

[Typical example]

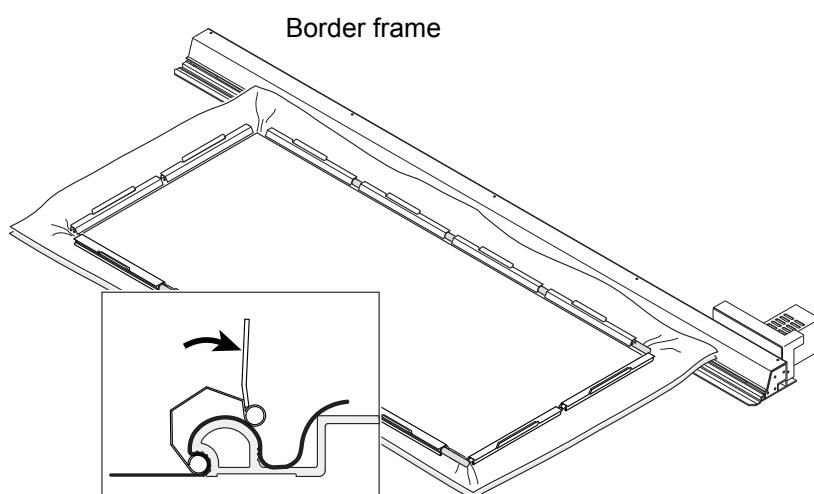
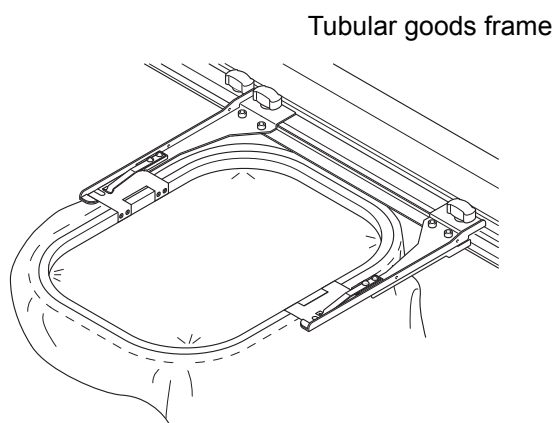
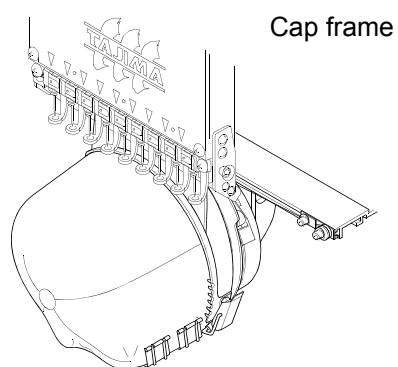

3. Registration of a design into the machine memory

Register designs in the machine memory by the following methods.

- (1) Use USB memory
- (2) Use personal computer (DG/ML by Pulse is necessary)

3-1. To use USB memory (Data Input USB)

Register designs saved in the USB memory into the machine memory. The maximum number of stitches per design is 1,000,000 stitches.

3-1-1. Screen

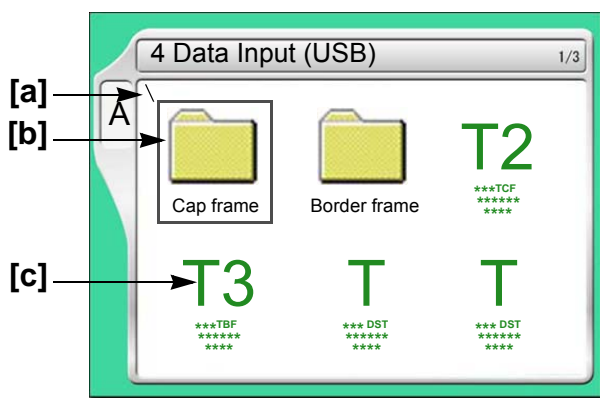

Folders and designs saved in the USB memory will be displayed. The design except the one shown at left will be displayed depending on a saving format of the design.

[a] Folder layer

The folder in the USB memory can be read up to three levels. The total of folders and designs that can be read per 1 layer directory is 255 designs.

- \ : Root folder
- \\ : Folder (First level)
- \\\ : Folder (Second level)
- \\\\ : Folder (3rd layer directory)

[b] Folder

[c] Design

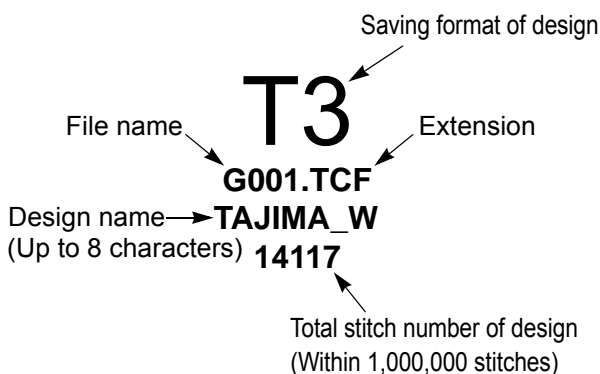

The extension differs depending on the saving format of the design.

- T3: TCF
- T2: TBF
- T: DST

For saving format of the design, refer to the detail page. (→p.31)

3-1-2. How to operate

The following is an example of registering a design saved in the USB memory into the machine memory.

(1) To set USB memory

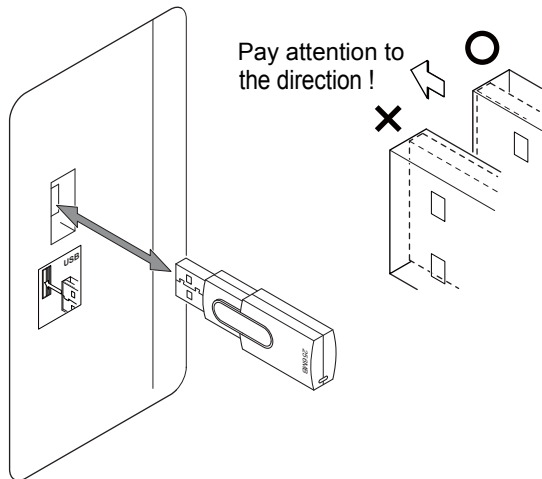

(2) To open screen

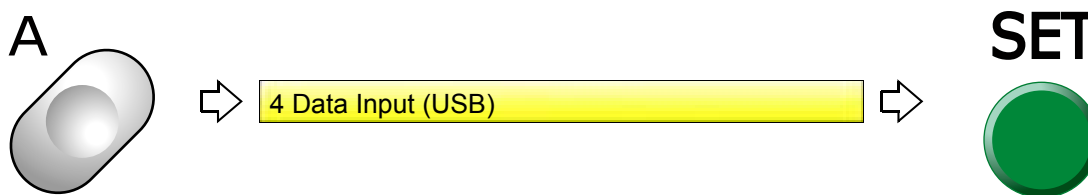

(3) To select a design

The operation differs depending on the storing place of the design.

(a) Design in folder

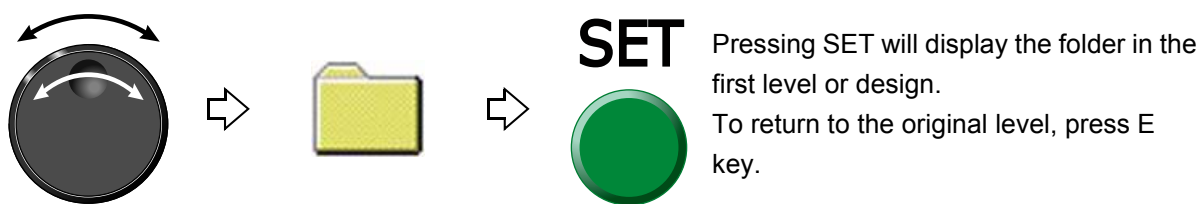

(b) Design on screen

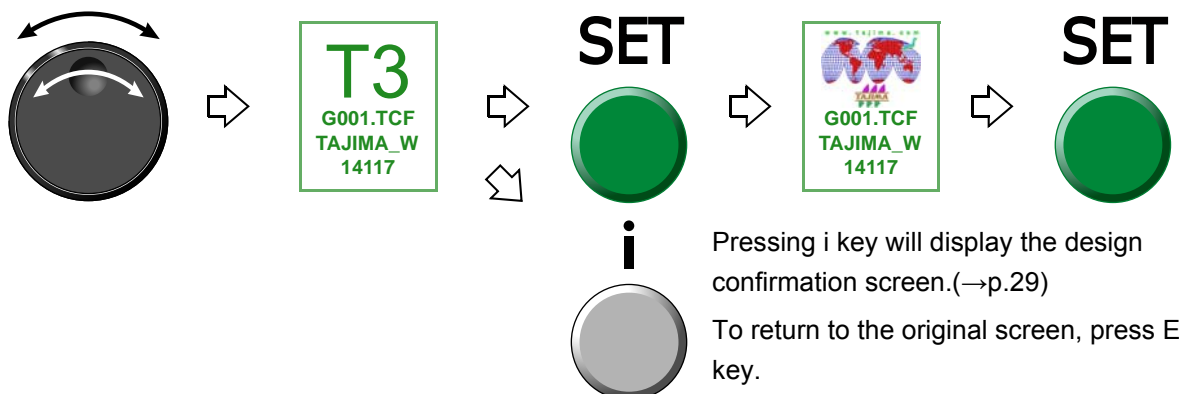

(4) To read condition file

If the saving format of the selected design is T3 or T2, the following message will appear.
Condition file means Color Change Sequence and Design Start Position.

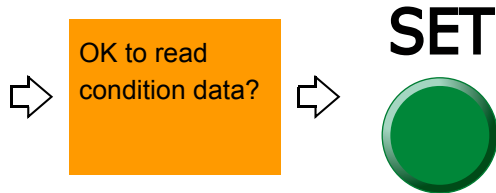

(5) To move frame to the design start position

⚠ CAUTION

⊘ When performing this operation, do not put your hands etc. on the machine table. Moving frame could injure you.

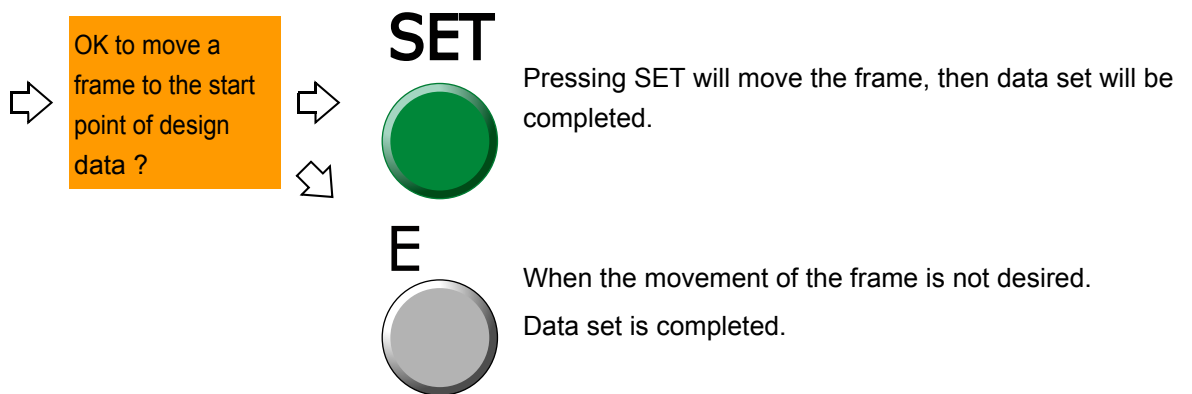

After that, proceed to "To decide color change sequence (Needle Bar Selection)"(→p.53).

1
2
3
4
5
6
7
8
9
10
11

When some message is written for the design (****.TCF), the below screen will be displayed.

To write the message into the design data (****.TCF), DG/ML by Pulse is necessary.

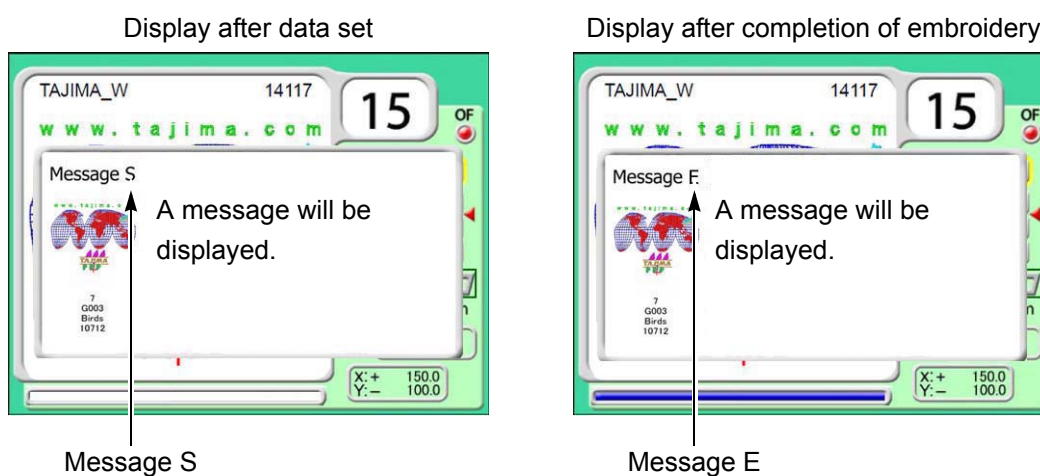

Besides, when the data of the design (****.TCF) in which the message is written is set, if i key is pressed, the detail of the message can be checked.

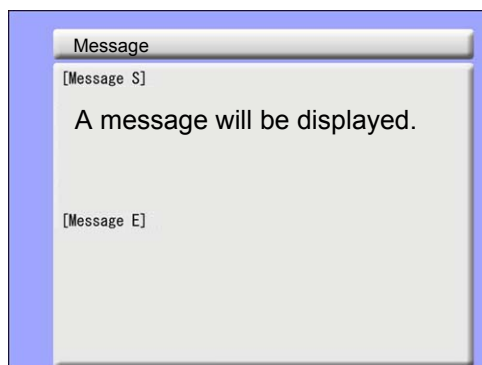

3-2. To use personal computer (Data Input LAN)

Register designs (saved in the personal computer) into the machine memory. Besides, it is possible to more easily register the designs into the machine memory using a commercially available bar code reader (*). The maximum number of stitches per design is 800,000 stitches.

(*) It is possible to use only the USB connection bar code reader supporting CODE39.

Software sold separately (DG/ML by Pulse) and setting of IP address are necessary to perform this operation. For details, consult the distributor.

[Example of connection]

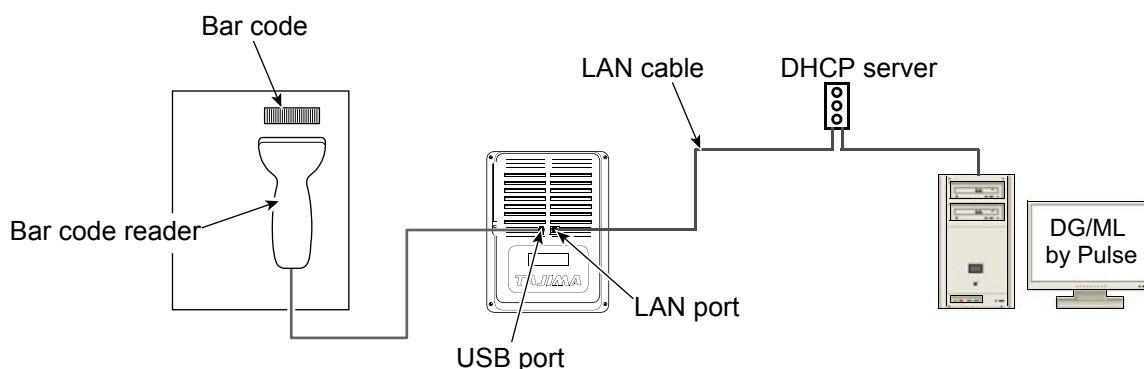

3-2-1. Screen

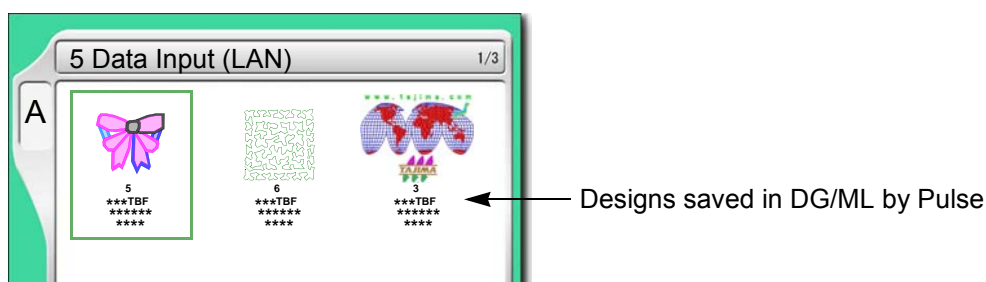

3-2-2. How to operate (not to use bar code reader)

The following is an example of registering a design (saved in a personal computer) into the machine memory.

- (1) After connecting the LAN cable to the LAN port at the back of the operation panel, start up DG/ML by Pulse.
- (2) Check if network setting is "YES".(→p.193)
- (3) To open screen

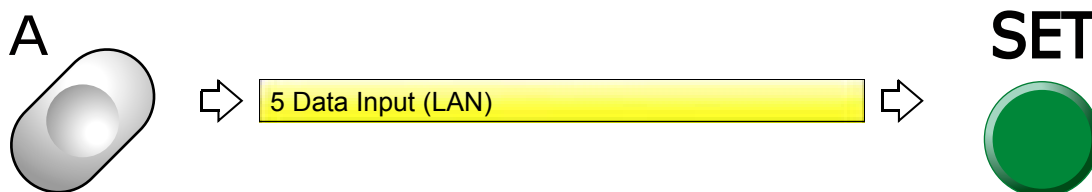

(4) To select a design



(5) To read condition file

If the saving format of the selected design is T3 or T2, the following message will appear.
Condition file means Color Change Sequence and Design Start Position.

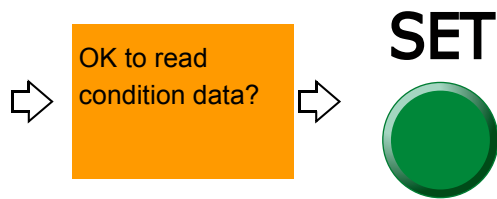

(6) To move frame to the design start position

⚠ CAUTION

⊘ When performing this operation, do not put your hands etc. on the machine table. Moving frame could injure you.

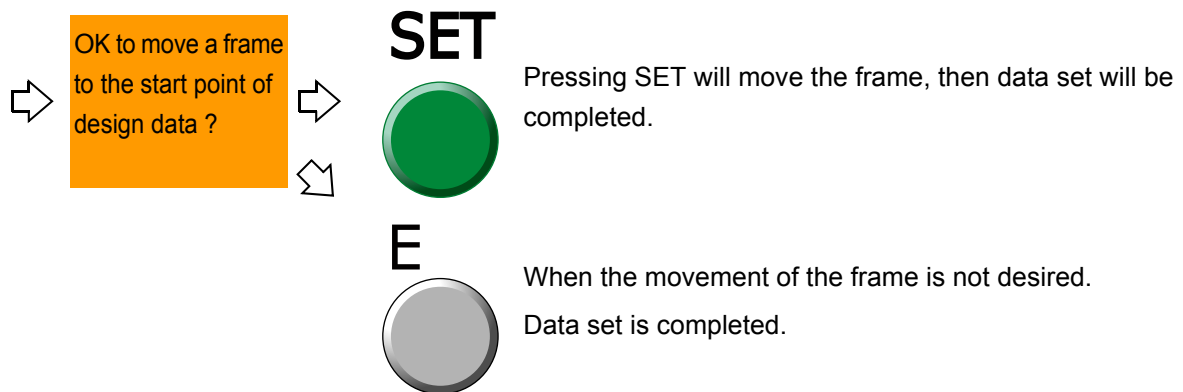

After that, proceed to "To decide color change sequence (Needle Bar Selection)"(→p.53).

3-2-3. How to operate (to use bar code reader)

The following is an example of registering a design (saved in a personal computer) into the machine memory.

- (1) After connecting the LAN cable to the LAN port at the back of the operation panel, start up DG/ML by Pulse.
- (2) Check if network setting is "YES".(→p.193)
- (3) Connect the bar code reader to the USB port of the operation panel.(→p.20)

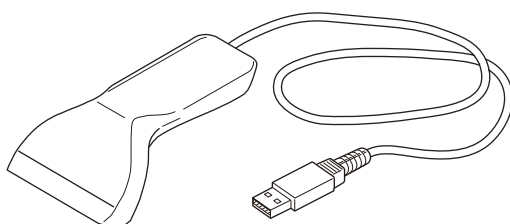

- (4) Set to the main screen.

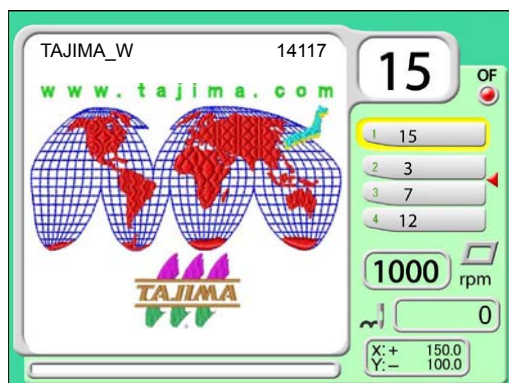

The bar code can be read also from the following screen.

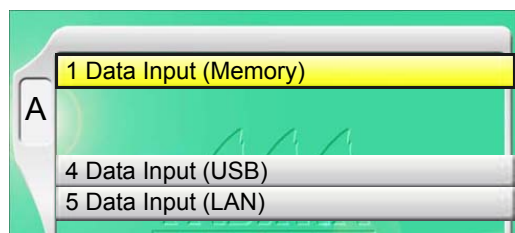

- (5) Read the bar code.

Condition data (Color change sequence) is also read automatically.

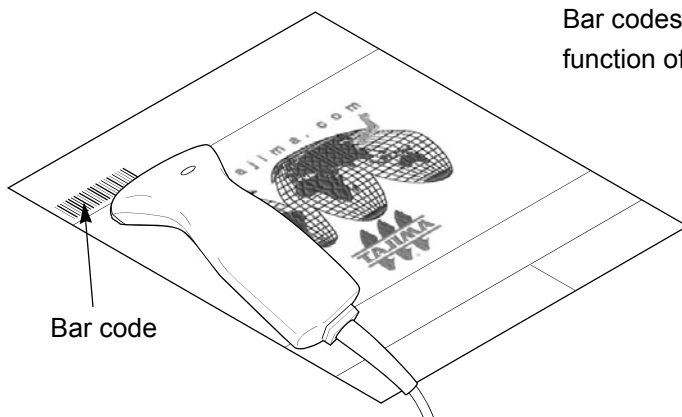

Bar codes can be printed by using the print function of DG/ML by Pulse.

This design is now ready for embroidery. (Data set is completed).

After that, proceed to "To decide color change sequence (Needle Bar Selection)"(→p.53).

3-2-4. How to use a bar code reader during machine operation

Read the bar code of the next embroidery design by a bar code reader. (Pre-reading of the next design)

The pre-read design is set right after the current embroidery design is completed, and then a yellow bar will be displayed.

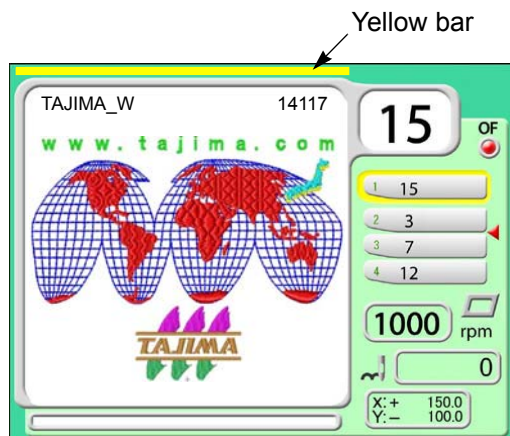

When performing the following operation, the yellow bar will disappear.

- (a) When performing panel operation
- (b) When the machine is started/stopped
- (c) When the power is turned OFF and ON

The pre-read design requires the following conditions.

- (a) The design which can be performed pre-reading is one design only.
- (b) When bar codes are read plural times during operation, the design read latest will be selected.
- (c) When suspending to embroider a design during operation and setting the data of another design, the pre-read design will be deleted.
- (d) To suspend embroidering some design during operation and perform the data setting of the pre-read design, read the bar code again.
- (e) When performing the Frame Forward of the design in the middle of embroidering and outputting the end code, the pre-reading design will not be set the data.

If the bar code cannot be read, error code No.BC1 will be displayed. The following points are given as factors.

(a) Selected design is not stored in Spooler

Spooler: Area to store the design temporarily in a personal computer

(b) Misreading by bar code reader

Deal with above troubles with the following procedure. If these troubles are not solved, please consult the distributor.

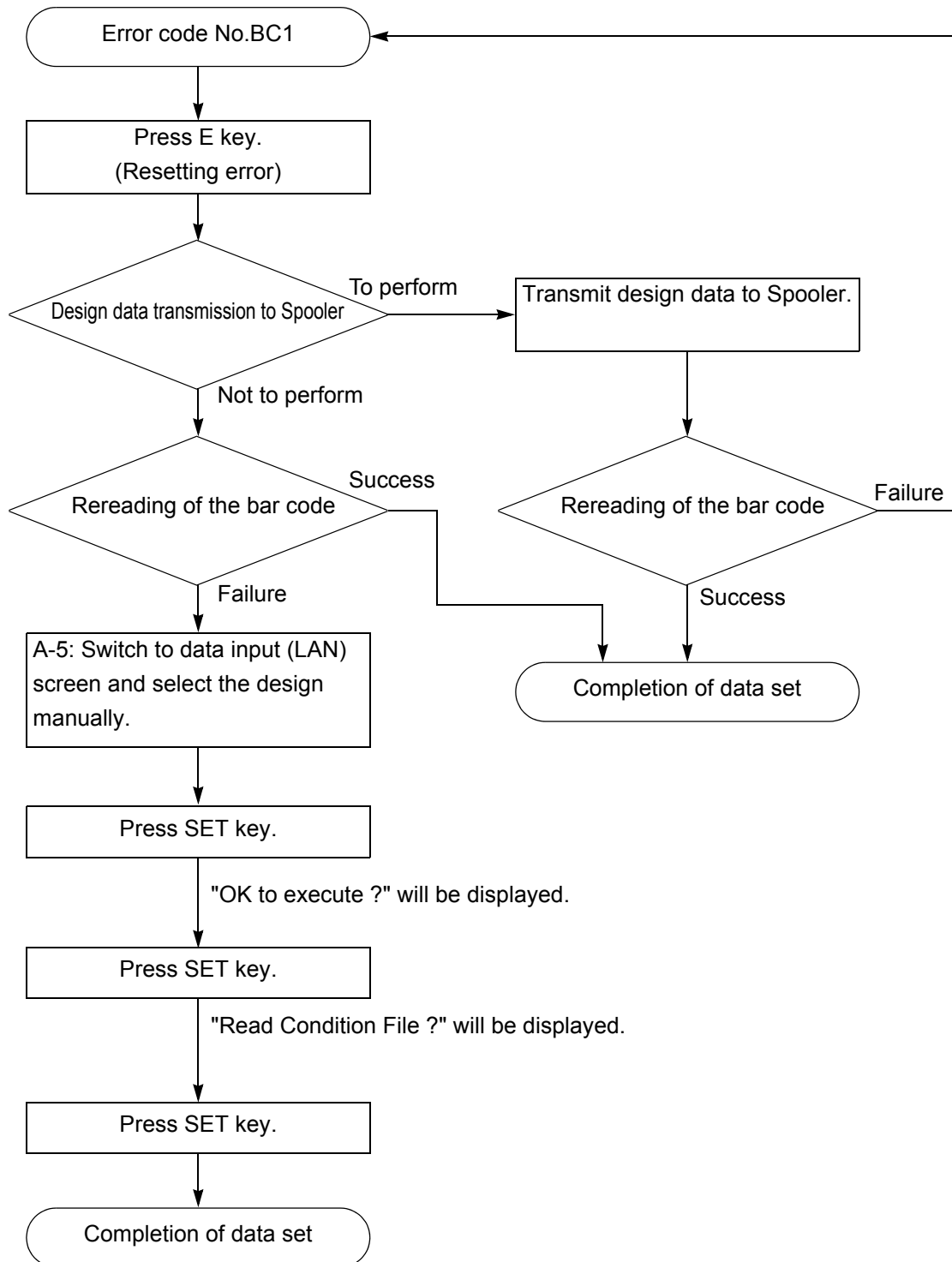

4. Decision of an embroidery design and the color change sequence

4-1. To decide embroidery design (Data Setting)

Select the design in the machine memory and enable to embroider.

4-1-1. Screen

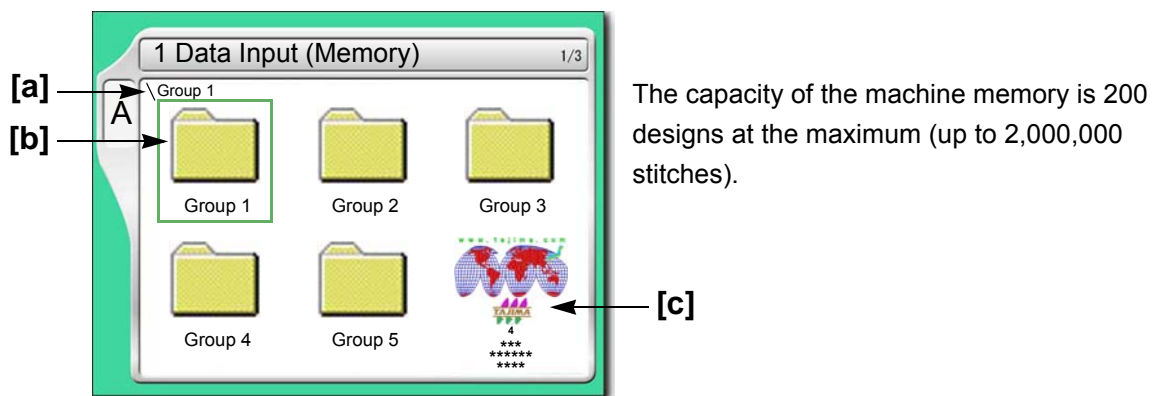

[a] Folder layer

The root folder and folder on the first level of the machine memory can be displayed.

\ : Root folder

\\: Folder Group 1 to 5 (First level)

[b] Folder

Folder name can be changed.(→p.178)

[c] Design registered in the machine memory

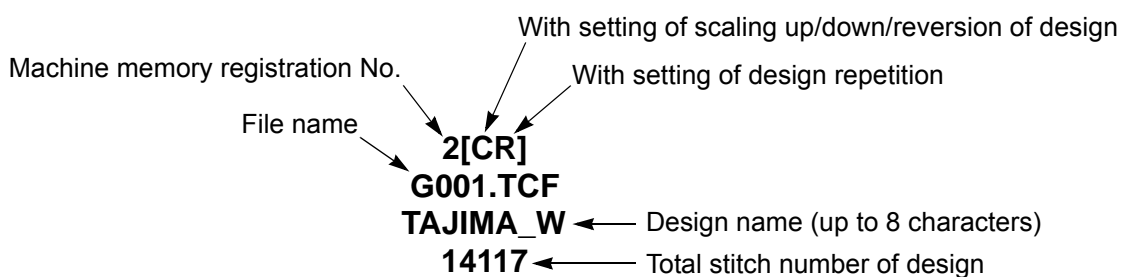

4-1-2. How to operate

This is an example of selecting the design in the memory of the machine and enabling to embroider.

(1) To open screen

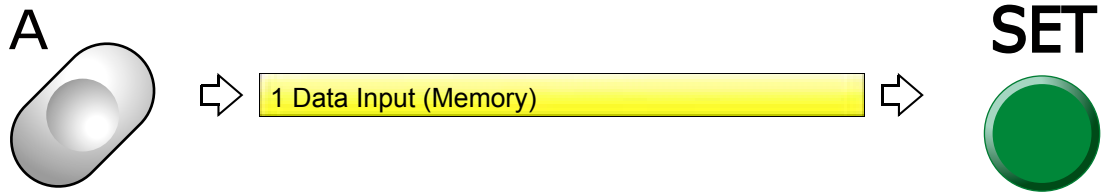

(2) To select a design

The operation differs depending on the storing place of the design.

(a) Design in folder

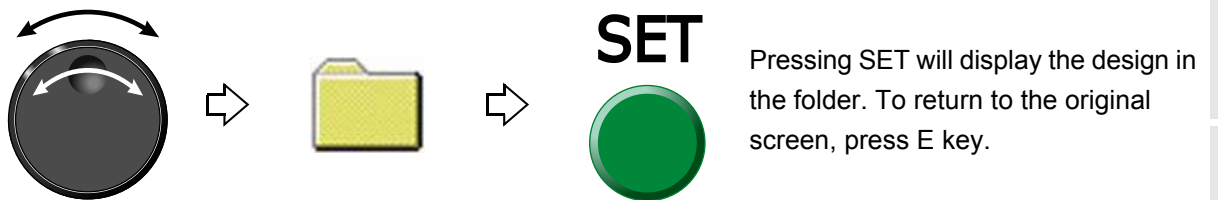

(b) Design on screen

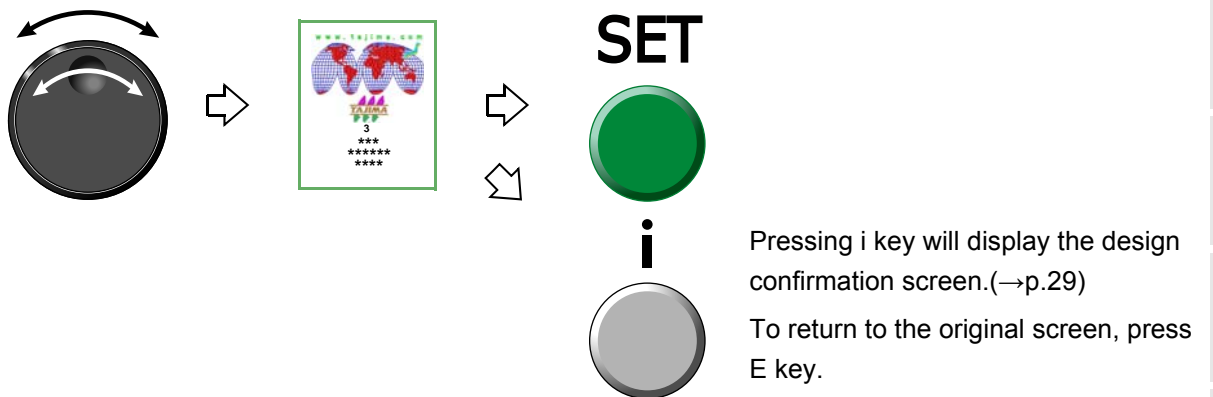



1
2
3
4
5
6
7
8
9
10
11

(3) To move frame to the design start position

 **CAUTION**

 When performing this operation, do not put your hands etc. on the machine table. Moving frame could injure you.

 OK to move a frame to the start point of design data ? 

SET  Pressing SET will move the frame, then data set will be completed.

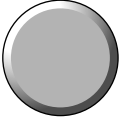
E  When the movement of the frame is not desired. Data set is completed.

4-2. To decide color change sequence (Needle Bar Selection)

This setting is unnecessary when the color change sequence is already included as the condition data in the design to be embroidered from now.

4-2-1. Screen

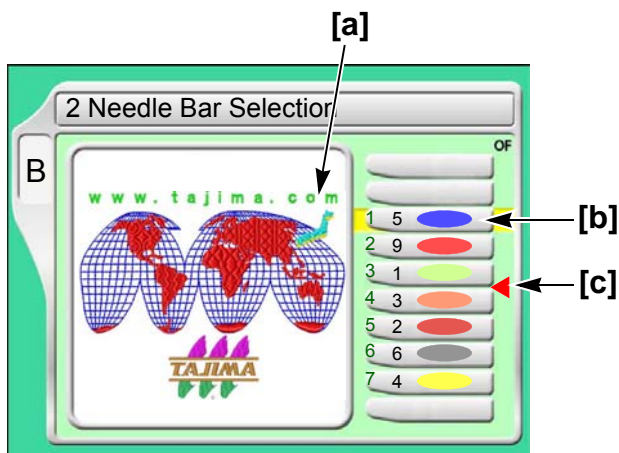

[a] Design (data set design) to be embroidered from now

[b] Step

The section divided by a color change code in the design data. The first section is called step 1, and the next section is called step 2.

Step display differs depending on with/without setting of "Auto Color Change (AC)".

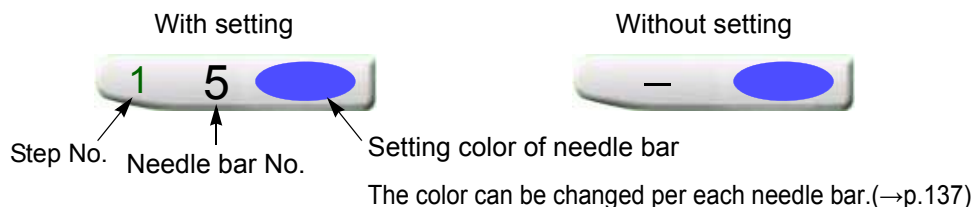

When Sequin device III is mounted, the following display will appear.

When sewing with the right device

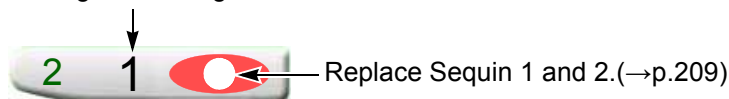

When sewing with the left device
(An example of 9-needle machine)



[c] Offset mark

The illustrated example shows that the frame moves to the front after finishing of step 3. (→p.166)

However, to move the frame, the setting of "Automatic Offset" is necessary.(→p.164)

4-2-2. How to operate (not to insert offset mark)

The following is an example of setting step 1 to the needle bar No.4.

(1) To open screen

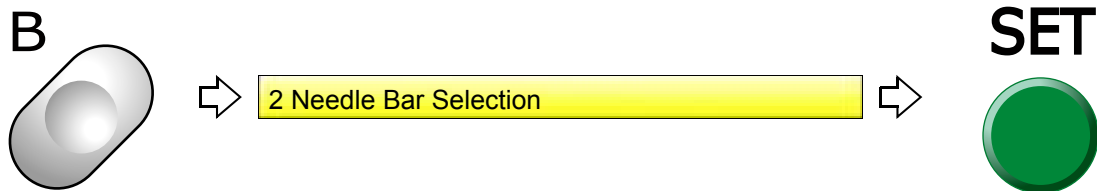

(2) To select needle bar No. to use at step 1

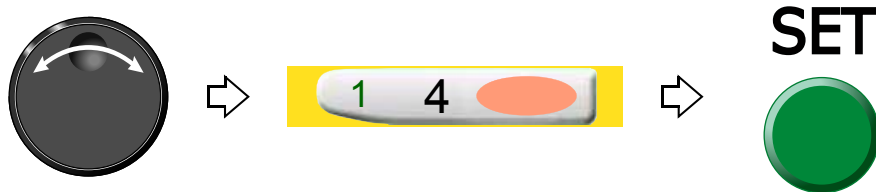

Set also other needle bar No. in the same procedure.

4-2-3. How to operate (to insert offset mark)

The following is an example of inserting the offset mark between step 2 and step 3.

(1) To select step to insert offset mark



(2) To insert offset mark

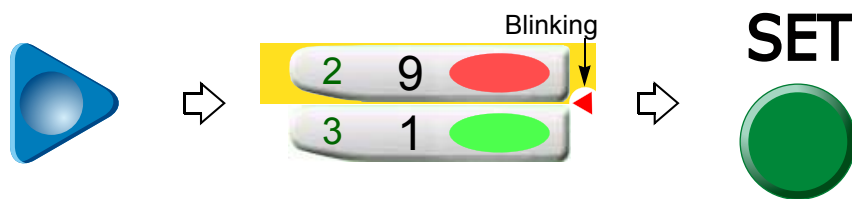

To delete the offset mark

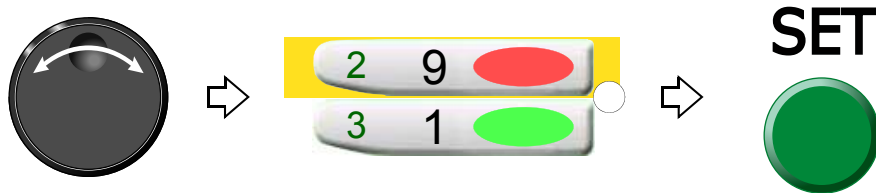

4-3. To change color automatically / to start operation automatically
(Auto Color Change "AC" / Auto Start "AS")

4-3-1. Screen

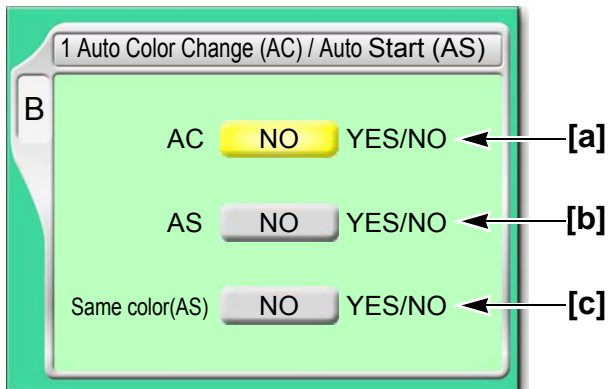

[a] Setting to perform color change automatically according to the color change sequence

YES: To perform

NO: Not to perform

When you desire to embroider by single color without color change, select "NO". Selecting "NO" will disable the following settings.

[b] Setting to start operation automatically after color change

YES: To perform

NO: Not to perform

Selecting "NO" will disable the following settings.

[c] Setting to start operation automatically when the same needle bar No. is selected at the previous and the next steps.

YES: To perform

NO: Not to perform

The below example shows that selecting "NO" will stop the operation after step 1 is finished. When you want to stop only the desired step individually, select "NO".

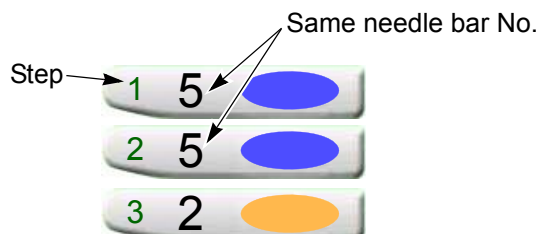

4-3-2. How to operate

The following is the example of setting in the conditions below.

Auto Color Change (AC)

Auto Start (AS)

Automatic Start at the same color

(1) To open screen

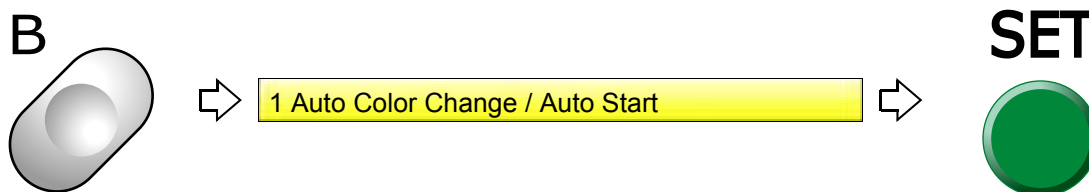

(2) Auto Color Change (AC)



(3) Auto Start (AS)



(4) Automatic Start at the same color

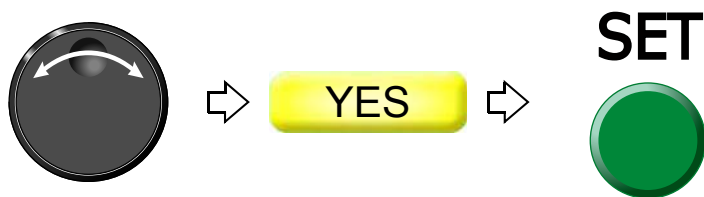

5. Decision of the design start position

5-1. To check design size and setting contents of design (Check of design)

Check setting conditions such as size, scale up/down, repeat, etc of the design to be embroidered from now. Use the checking result as rough standard when deciding the design start position.

For this function, refer to the detail page.(→p.29)

5-1-1. Explanation on the screen

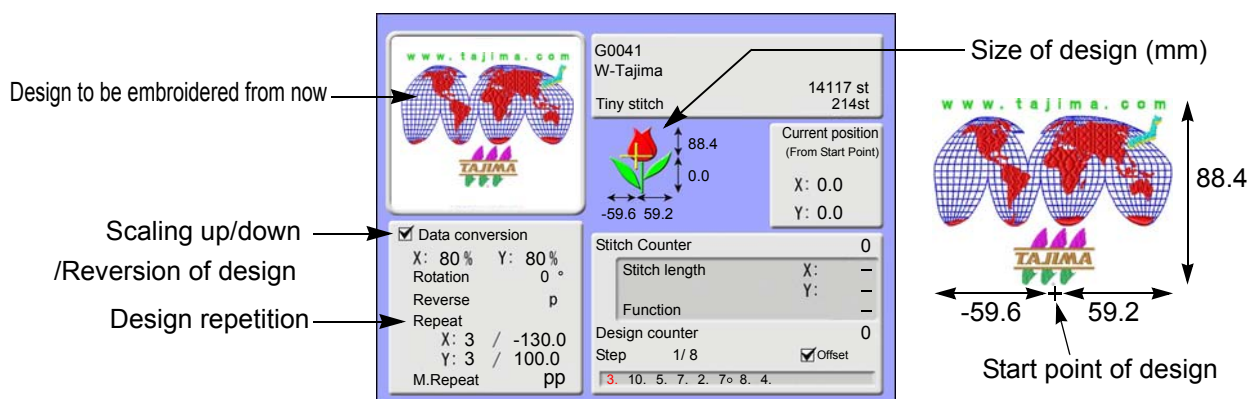

The size after scaling up/down will be displayed with the value based on the design start position. This example shows the size of vertical 88.4 mm and horizontal 118.8 mm.

5-1-2. How to operate

(1) To open screen

Press i key.

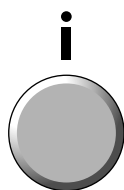

After pressing this key again, setting contents in detail and the code No. occurred up to now can be confirmed.

To return to the main screen, press E key.

5-2. To lower the needle bar to adjust the frame position (Needle bar operation)

This function does not correspond to TFMX-C, TWMX-C.

5-2-1. Screen



↑
Up: To raise needle bar
Down: To lower needle bar

5-2-2. How to operate

! CAUTION

⊘ When performing this operation, do not put your hands etc. near the needle. Moving up/down of the needle bar could injure you.

The following is an example of lowering the needle bar.

(1) To open screen

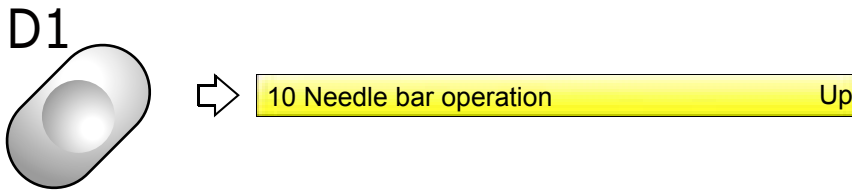

(2) To lower needle bar



5-3. To move frame to the design start position (Manual frame travel)

This operation is unnecessary when the frame has already come to the start position of the design by the operation described previously.

5-3-1. Explanation on the screen

Main screen

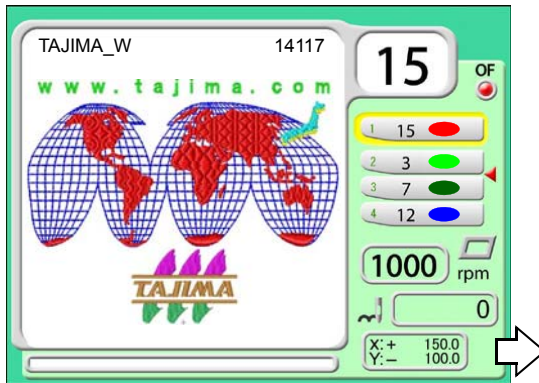

The current frame position is displayed by the numerical value (mm). The frame position is based on the frame origin.

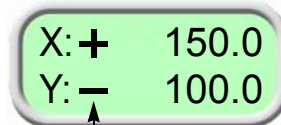

The code (+/-) means the frame travel direction.

[Relation between frame travel direction and code]

- (1) If the frame moves to the rear, the code will be "Y:-".
- (2) If the frame moves to the front, the code will be "Y:+".
- (3) If the frame moves to the right, the code will be "X:-".
- (4) If the frame moves to the left, the code will be "X:+".

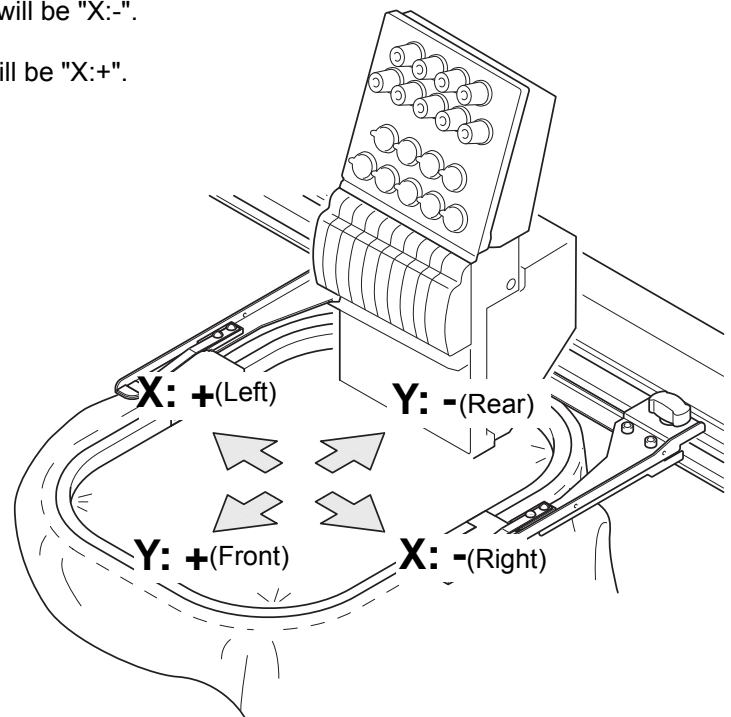

5-3-2. How to operate

There are following two methods.

! CAUTION

 When performing this operation, do not put your hands etc. on the machine table. Moving frame could injure you.

(1) To use Frame Travel key**(a)** Switch to the main screen

Press E key plural times to switch to the main screen.

(b) To move frame to the design start position

Press any desired key. The frame will move.

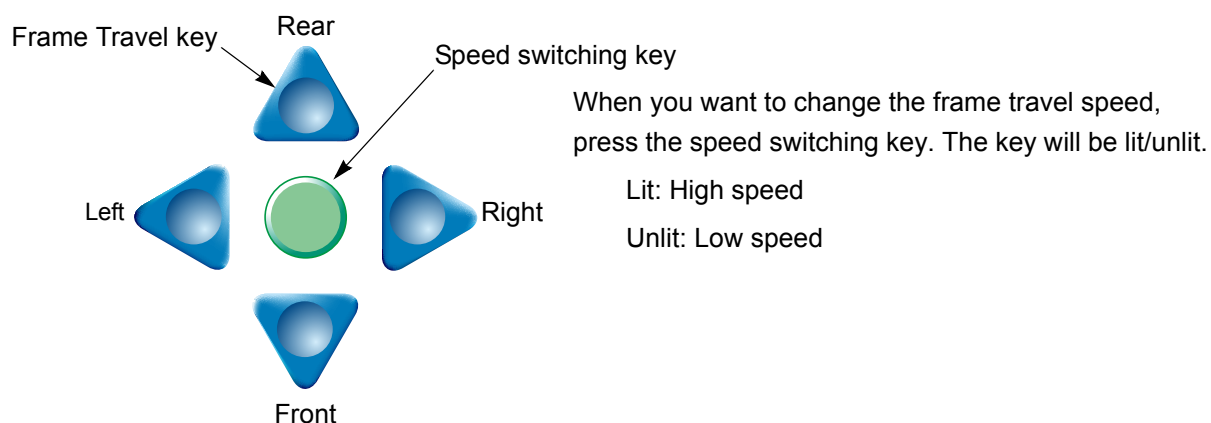
**(2)** To use Jog dial/Jog shuttle**(a)** Switch to the main screen

Press E key plural times to switch to the main screen.

(b) To decide Frame Travel direction

Press E key to decide the frame travel direction.

It moves vertically.

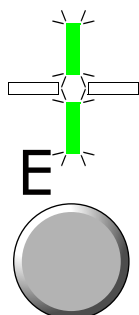

It moves horizontally.

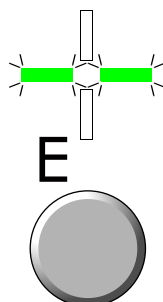

(c) To move frame to the design start position

Turn the jog dial (low speed) / the jog shuttle (high speed). The frame will move.

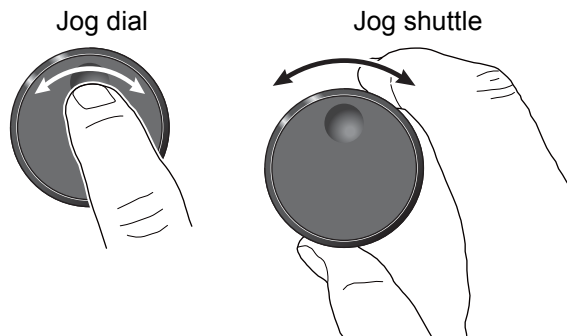
**(3) To use the Jog remote-controller (some models only)****(a) Switch to the main screen**

Press E key plural times to switch to the main screen.

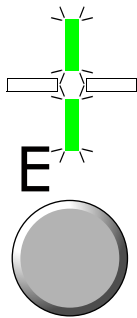
**(b) To move frame to the design start position**

Tilt the stick. The frame will move.

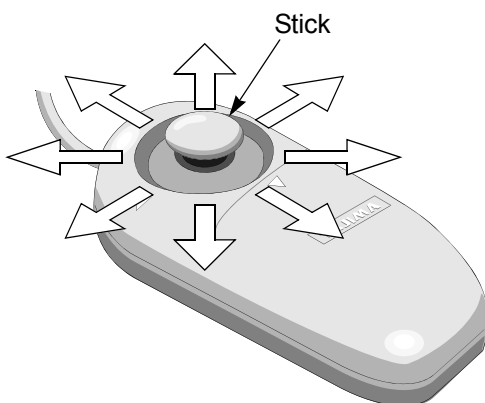

Frame travel speed will be changed by degree of leaning condition of the stick.

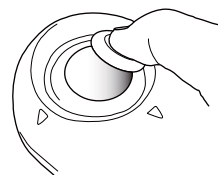

1

2

3

4

5

6

7

8

9

10

11

5-4. To check if design fits in embroidery space (Trace)

Since the frame moves according to the size of the design, you can check whether the design fits in the embroidery space or not.

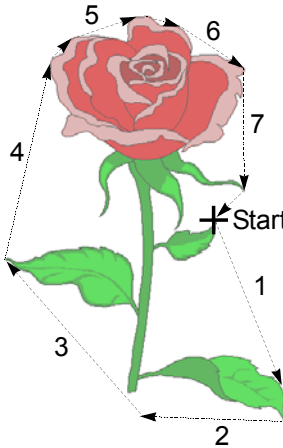

The number in the left figure indicates the orbit of the frame. After completion of trace, embroidering from that position is possible.

When repeat is set

The machine will trace whole designs after tracing the first design.

When Automatic Offset is set

The machine traces according to the setting.

5-4-1. Screen

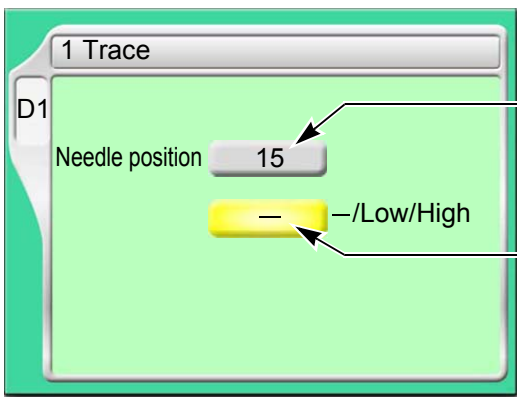

Current needle bar No.

The frame will move on the basis of this needle bar.

Speed of frame travel

Low: Low speed

High: High speed

-: Not to execute

5-4-2. How to operate

CAUTION

When performing this operation, do not put your hands etc. on the machine table. Moving frame could injure you.

The following is an example of executing Trace.

(1) To open screen

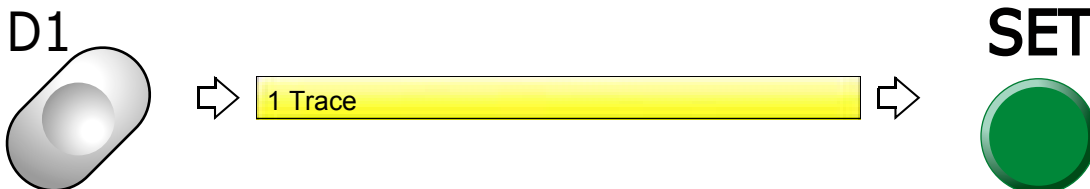

(2) To execute

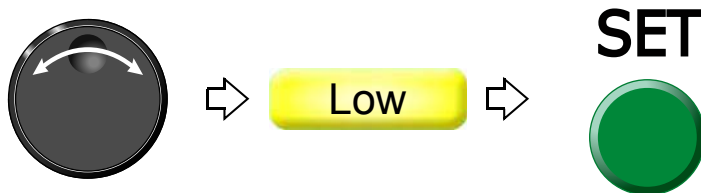

When the tracing is impossible due to the design size exceeding the embroidery space, follow the procedure below after checking the size of the design.

- (a)** The frame will move again after temporary stop.
- (b)** Code No.225 will be displayed.
Press E key.
- (c)** Move the frame to the design start position.
- (d)** Perform tracing again.

To suspend tracing, follow the procedure below.

- (a)** Suspend the operation by the stop switch.
Code No.1C1 will be displayed.
Do not turn OFF the power while the code No.1C1 is displayed.
- (b)** Press E key.
- (c)** After that, follow the message described below.

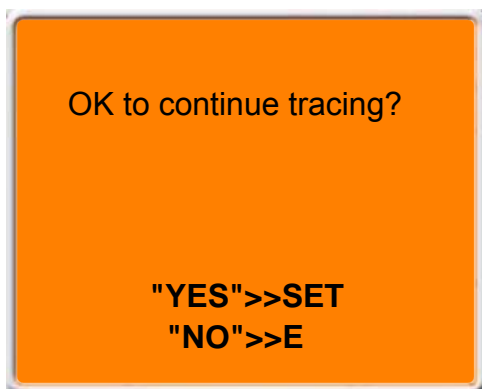

To continue → SET key
To suspend → E key

1
2
3
4
5
6
7
8
9
10
11

6. Check items before embroidering

6-1. Maximum speed (Maximum RPM)

The value set here will be the maximum speed of the machine. It is automatically increased/decreased depending on stitch length in the middle of embroidery.

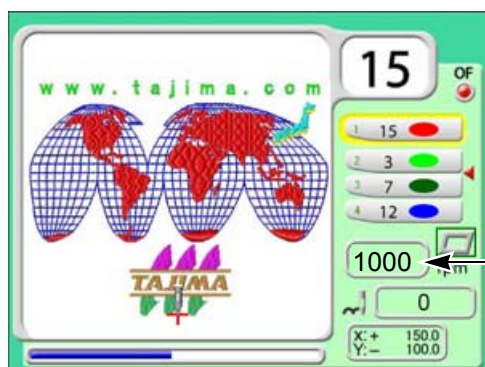

Speed display column

During stop: The maximum speed is displayed.

During operation: Actual operating speed is displayed.

Stitch length	Embroidery speed
Up to 4.0 mm	Maximum speed (A in the right figure)
4.1 mm to 11.9 mm	Automatic change (B in the right figure)
12.0 mm or more	Low speed (C in the right figure)

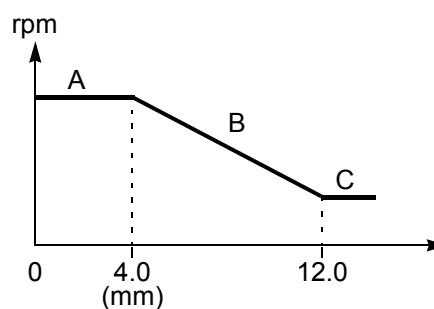

6-1-1. Screen



↑
Maximum speed

6-1-2. How to operate

The following is an example when setting the maximum speed to "950".

(1) To open screen

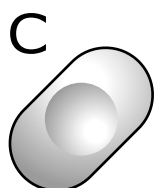

(2) To select maximum speed

Selection of the value exceeding "Max. Revolution Limit" is not possible.

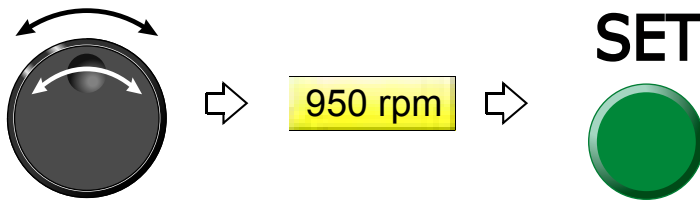

To change the maximum speed during operation of the machine, turn the jog dial / the jog shuttle.

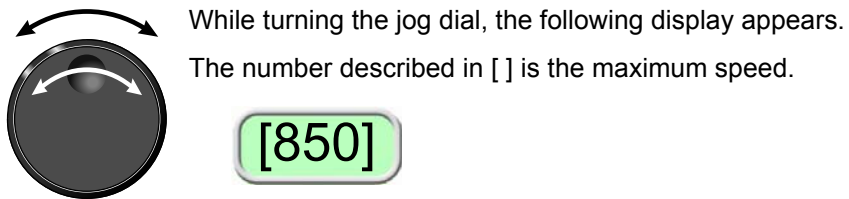

1
2
3
4
5
6
7
8
9
10
11

6-2. Embroidery head

Check the position of the following tension base switch, needle bar suspension lever, middle thread guide adjusting lever before embroidery.

Regarding the tension base switch and the needle bar suspension lever, embroidering is possible only when both of them are set to "ON".

(1) Tension base switch

This switch will suspend the head electrically.

The switch operation during working of the machine is invalid. Even if the switch operation is performed, it will become effective after the machine stops.

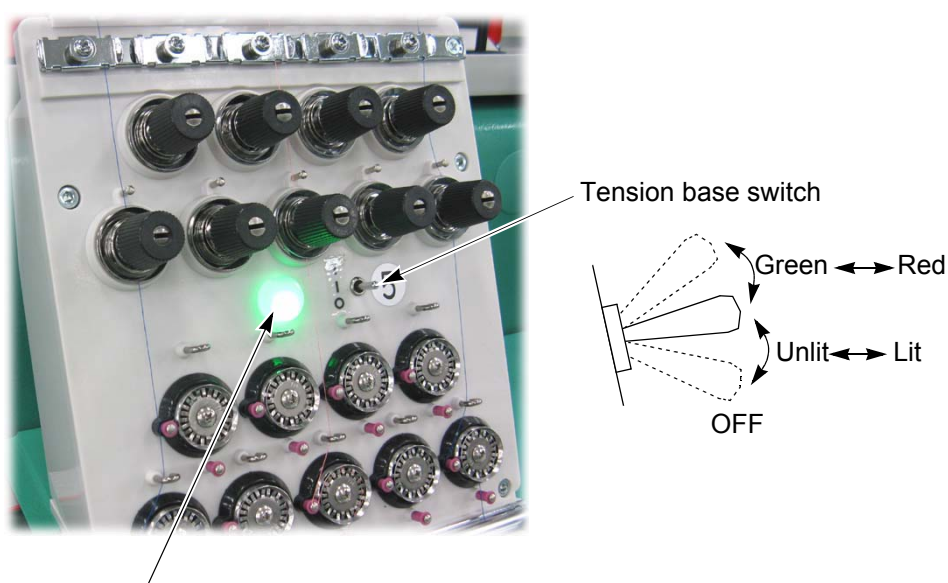

Thread breakage indicator lamp

Lit in green	Ready to embroider
Unlit	Embroidery is suspended. (Needle bar will not move down.)
Blinking in green	Frame back section at the head without thread breakage. The lamp at the head without thread breakage blinks in green during Frame Back Regarding Frame Back, refer to the detail page.(→p.69)
Lit in red	Upper thread breakage
Blinking in red	Under thread breakage

(2) Needle bar suspension lever (equipped only to 2 or more heads machine)

This lever will suspend the head mechanically.

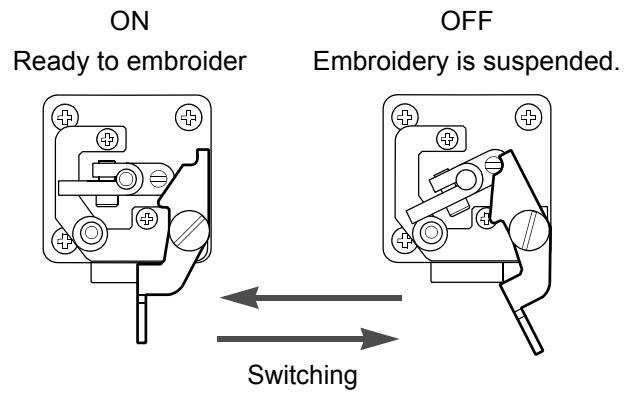
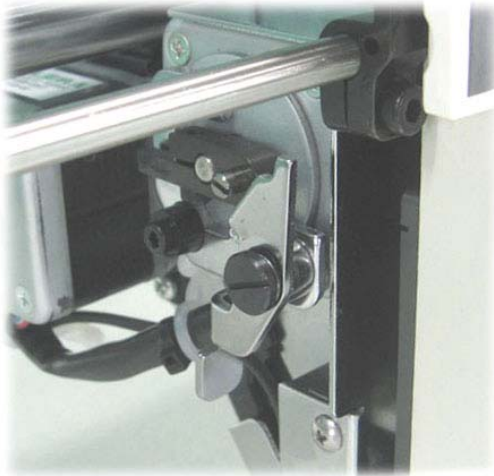

(3) Middle thread guide adjusting lever

Move the lever so that the screw faces the front.

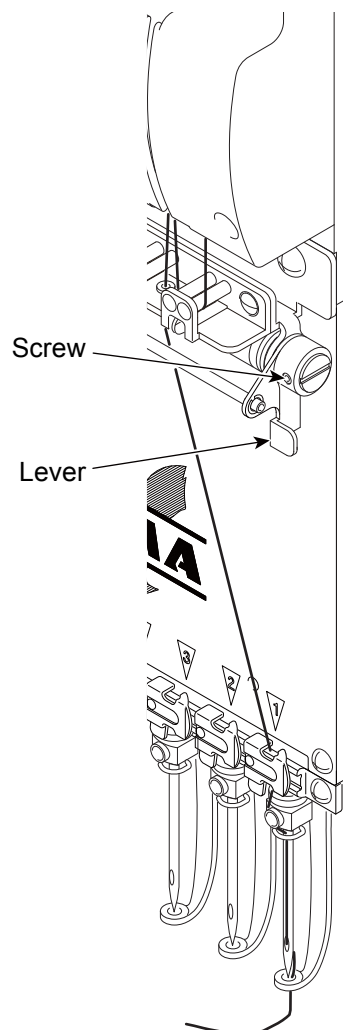

If embroidery is performed under the following condition, thread breakage would be caused or thread tension would be affected badly.



1
2
3
4
5
6
7
8
9
10
11

7. Embroidery starts

7-1. Start and stop

7-1-1. Start/stop switch

Target models: TFMX-C, TWMX-C, TFMX-IIC TYPE-2

! CAUTION

! Before starting the machine, pay enough attention to the surrounding safety. Moving needle bar and/or frame could injure you.

- (1) When starting the operation, press the start switch.
- (2) To stop the machine, press the stop switch.
- (3) To start slow operation, keep on pressing the start switch. Releasing it will start normal operation.

TFMX-C, TWMX-C

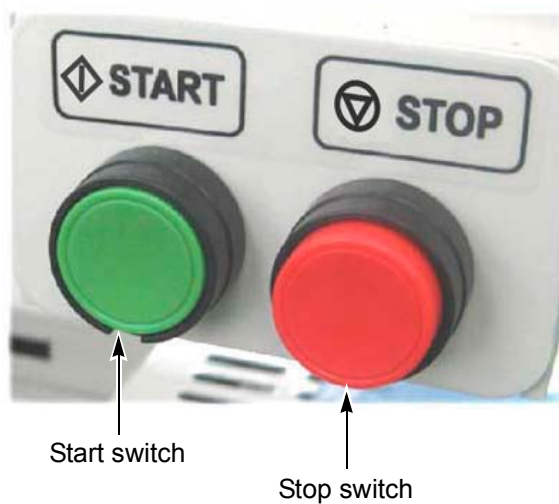

TFMX-IIC TYPE-2

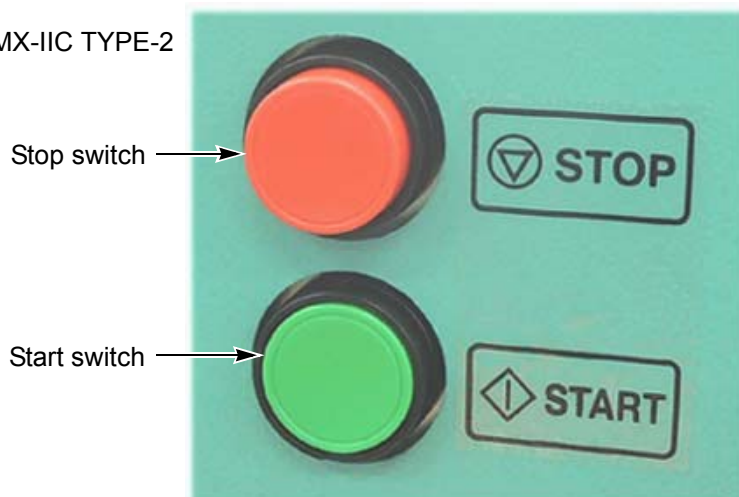

7-1-2. Bar switch

Target model: TFMX (L)



- (1) When starting the operation, move the bar switch to the right side.
- (2) To stop the machine, move the bar switch to the left side.
- (3) To start slow operation from the state that the machine stops, move the bar to the right side and hold it at the position. Releasing it will change to normal operation.

**7-2. Frame Back (to return the frame) / Frame Forward (to advance the frame)****Frame Back**

This function will return the frame to the direction of stitches returning in the state that the needle bar is stopped. The frame will be returned when thread breaks, and the repair stitches will be performed from that position.

Frame Forward

This function will advance the frame to the direction of stitches proceeding in the state that the needle bar is stopped. The frame can be moved immediately to the embroidery start point when you want to start from the middle of embroidery.

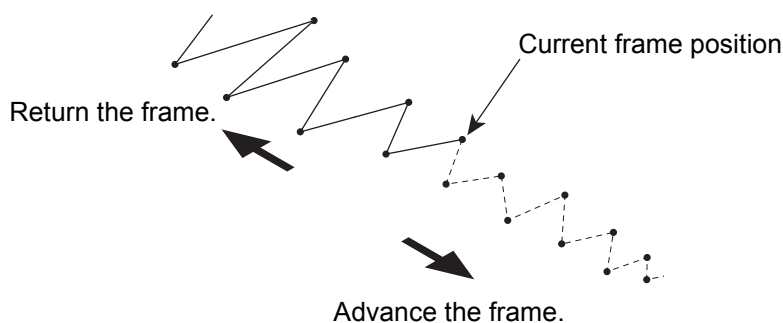

7-2-1. Frame Back

 **CAUTION**

 When performing this operation, do not put your hands etc. on the machine table. Moving frame could injure you.

Perform setting of Frame Back.(→p.146)

The setting of the machine will become Frame Back automatically at thread breakage.

(1) You want to return the frame for 1 stitch.

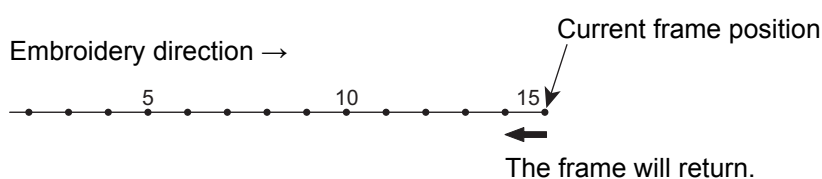

TFMX-C, TWMX-C, TFMX-IIC TYPE-2	Press the stop switch once.
TFMX (L)	Move the bar switch to the left, and return it immediately.

(2) You want to return the frame for several (2 to 10) stitches.

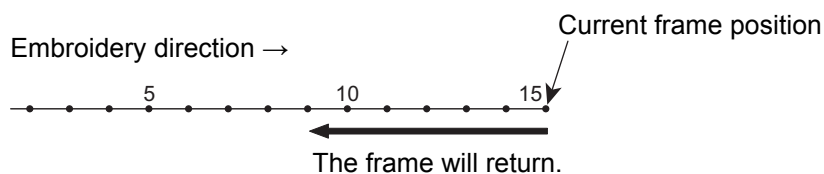

TFMX-C, TWMX-C, TFMX-IIC TYPE-2	Keep on pressing the stop switch. The frame will return stitch by stitch up to 10 stitches. To stop, release stop switch.
TFMX (L)	Move the bar switch to the left and hold it in that position. The frame will return stitch by stitch up to 10 stitches. To stop, return it to the original position.

(3) You want to return the frame for 11 stitches or more.

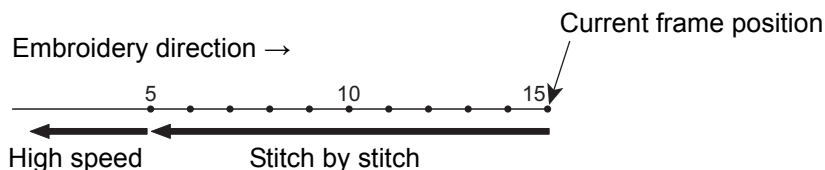

TFMX-C, TWMX-C, TFMX-IIC TYPE-2	Keep on pressing the stop switch. The frame will return stitch by stitch up to 10 stitches. For 11 stitches or more, the frame will return at high speed. ^[*1] To stop the machine, press the stop switch again.
TFMX (L)	Move the bar switch to the left and hold it in that position. The frame will return stitch by stitch up to 10 stitches. For 11 stitches or more, the frame will return at high speed. ^[*1] Returning to the original position will not suspend the machine operation. When suspending, move it to the left.

*1:For 11 stitches or more, the frame will return in units of the number of stitches being set.(→p.149)

7-2-2. Frame Forward

CAUTION

⊘ When performing this operation, do not put your hands etc. on the machine table. Moving frame could injure you.

Perform setting of Frame Forward.(→p.146)

(1) You want to advance the frame for 1 stitch.

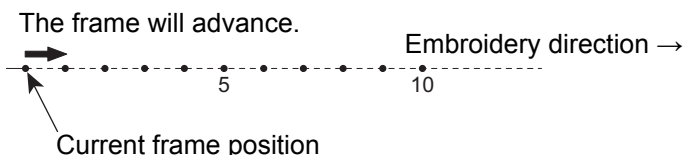

TFMX-C, TWMX-C, TFMX-IIC TYPE-2	Press the stop switch once.
TFMX (L)	Move the bar switch to the left, and return it immediately.

(2) You want to advance the frame for several (2 to 10) stitches.

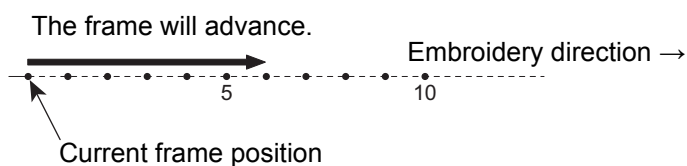

TFMX-C, TWMX-C, TFMX-IIC TYPE-2	Keep on pressing the stop switch. The frame will advance stitch by stitch up to 10 stitches. To stop, release stop switch.
TFMX (L)	Move the bar switch to the left, and hold it in that position. The frame will advance stitch by stitch up to 10 stitches. To stop, return it to the original position.

(3) You want to advance the frame for 11 stitches or more.

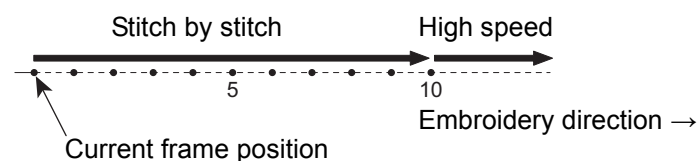

TFMX-C, TWMX-C, TFMX-IIC TYPE-2	Keep on pressing the stop switch. The frame will advance stitch by stitch up to 10 stitches. For 11 stitches or more, the frame will advance at high speed. ^[*1] To stop the machine, press the stop switch again.
TFMX (L)	Move the bar switch to the left, and hold it in that position. The frame will advance stitch by stitch up to 10 stitches. For 11 stitches or more, the frame will advance at high speed. ^[*1] Returning to the original position will not suspend the machine operation. When suspending, move it to the left.

*1:For 11 stitches or more, the frame will return in units of the number of stitches being set.(→p.149)

7-3. Handling of thread breakage

The machine will stop automatically and will be in the following condition.

(1) The thread breakage indicator lamp lights in red or blinks in green.

Lit in red: Upper thread has broken.

Blinking in red: Under thread has broken.

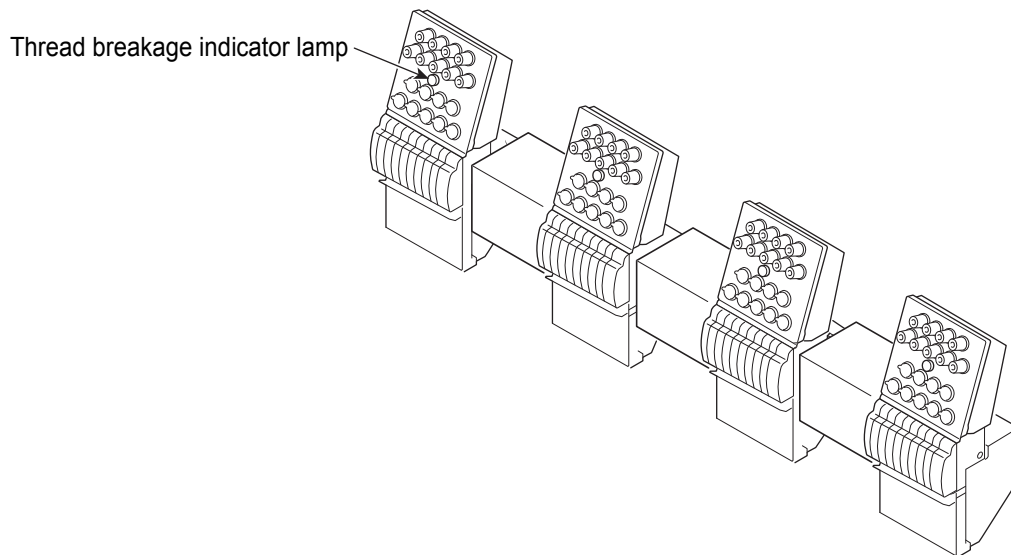

(2) Code No. (number indicating stop factor) will be displayed on the operation panel.

[291]: Upper thread has broken.

[293]: Under thread has broken.

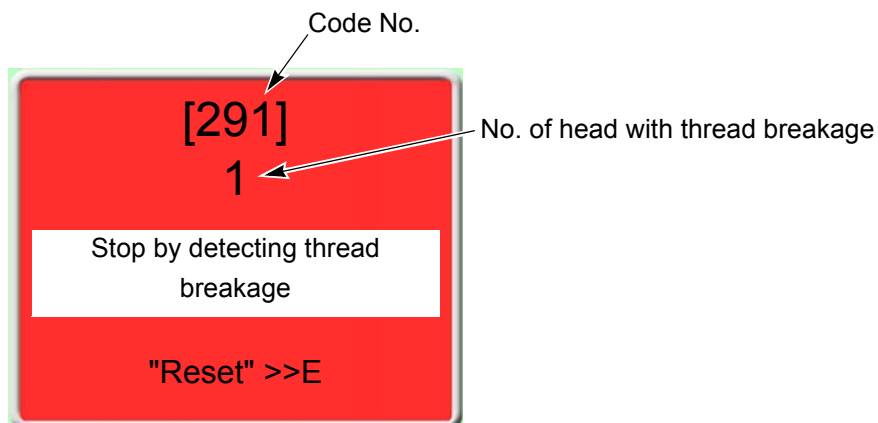

Restart the embroidery by the following procedure.

- (3)** Thread the needle, or change the under thread (bobbin case).

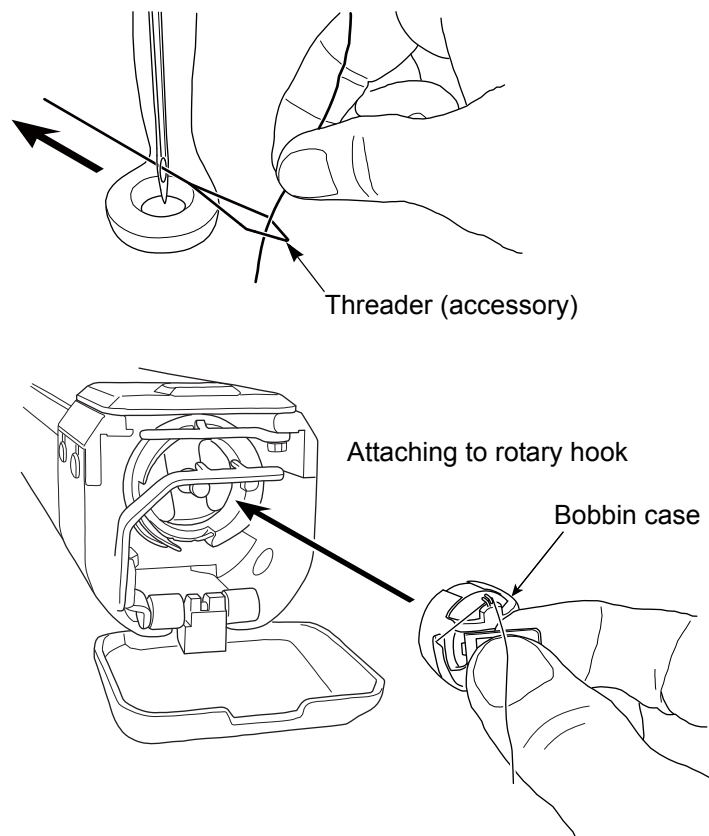

- (4)** Start the operation after performing Frame Back by several stitches.

Starting stitches after Frame Back differ between the head with thread breakage and the head without thread breakage.

[Head with thread breakage]

The machine restarts embroidering from the position where Frame Back stopped (1 in the figure below). As a result, repair stitches will be performed at the position 2 with missing stitches due to thread breakage.

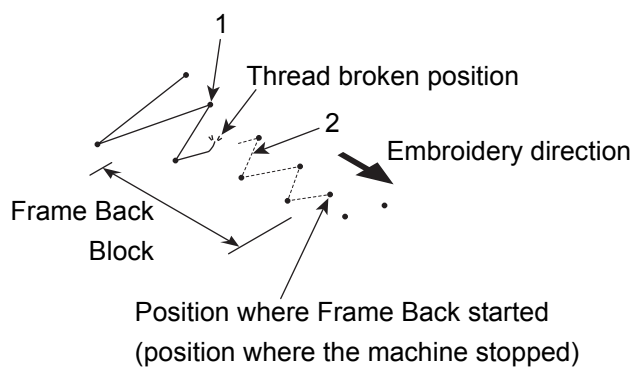

[Head without thread breakage (In case of 2 or more heads machine)]

The machine restarts embroidering from the position 3 next to where frame back started. This example is for the case "Frame Back All head Sew" is set as "0".(→p.150)

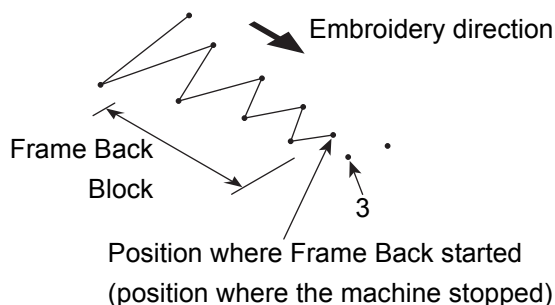

To make the head without thread breakage embroider from the position where frame back is stopped, set the tension base switch of the head to the "Top" once (when you release the switch, it will return to the original position).

Tension base switch

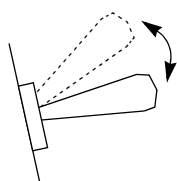

Thread breakage indicator lamp will change color from green to red.

7-4. Completion of embroidery

Destination of the frame movement differs depending on setting of the machine.

Setting of Automatic Offset	
Yes	No
<p>The frame will move to the offset start position.</p>	<p>The frame will not move. However, when Automatic Origin Return is set, the frame will move to the design start position.</p>

Chapter 5

Functions concerning embroidery

1. To change color	78
2. To trim thread.....	79
3. To set the embroidery speed	89
4. To stop the machine.....	92
5. To change the direction and the size of the design.....	98
6. To embroider the same design repeatedly.....	100
7. To adjust finishing of embroidering	104
8. To increase embroidering efficiency	117
9. To edit design.....	122
10. Setting and resetting of password	133
11. Functions that must be remembered	136

1. To change color

1-1. To change color manually (Manual Color Change)

1-1-1. Screen

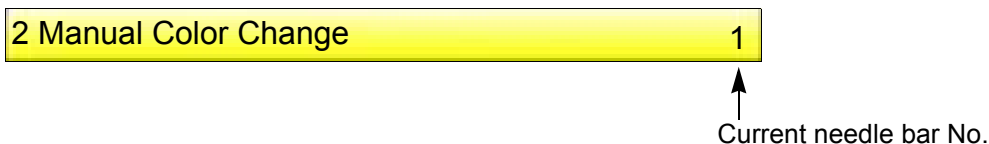

1-1-2. How to operate



The following is an example that the needle bar is changed color to the 5th needle.

(1) To open screen

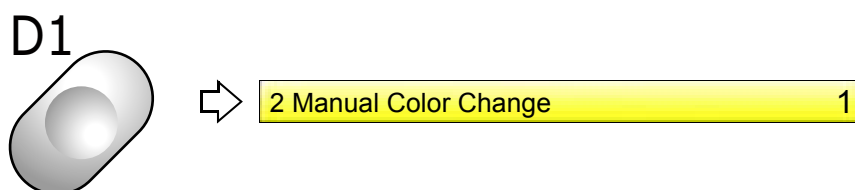

(2) To select needle bar No. and execute color change



2. To trim thread

2-1. To trim thread manually (Manual Thread Trimming)

2-1-1. Screen



○ : To trim thread

Under thread: To trim under thread only
(Excluding TFMX-C, TWMX-C)

If turning the jog dial while pressing "SET" with — is indicated, "Under thread" will be displayed.

2-1-2. How to operate



The following is an example of executing thread trimming.

(1) To open screen

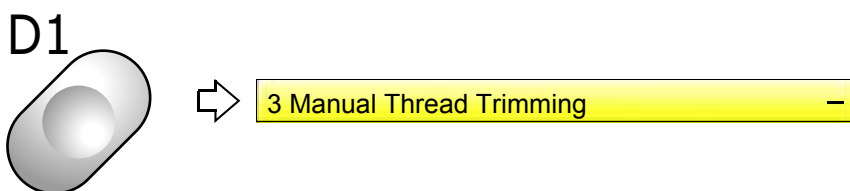

(2) To execute thread trimming

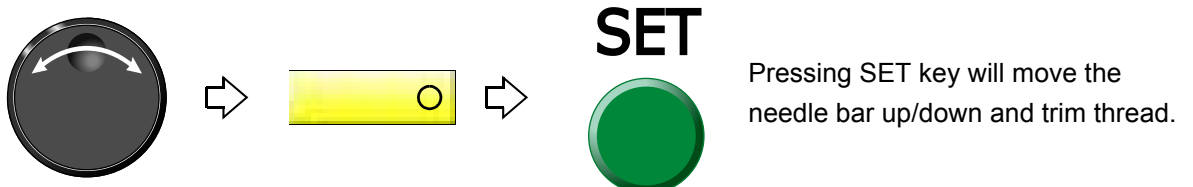

2-2. To trim thread automatically (ATH)

It is the setting to trim thread.

2-2-1. Screen

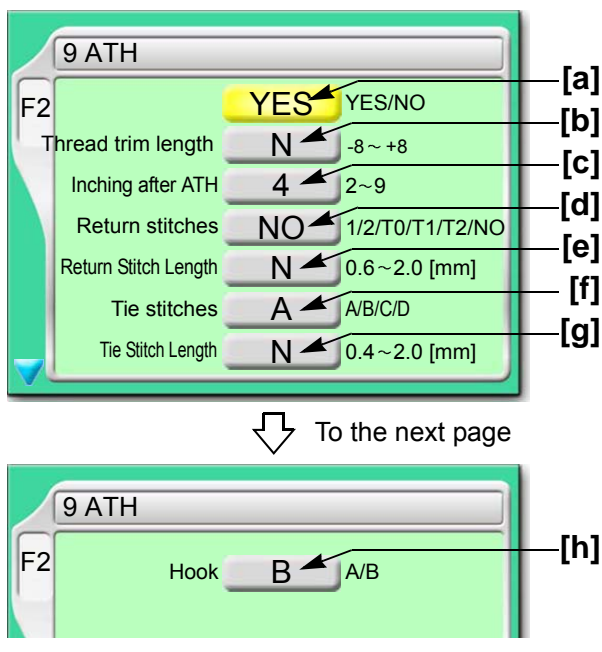

[a] To trim thread automatically

YES: To trim

NO: Not to trim thread

[b] Remaining length of upper thread after thread trimming (1 in the right figure)

-8 ← 0 → +8
Short Long

When upper thread remains on the fabric, select the value of "-".

If the thread does not link at the start of sewing due to short of remaining length of upper thread, select the value of "+".

When "N" is displayed, the value differs in each needle bar.

Regarding the setting of needle bar unit, refer to detailed page.(→p.108)

[c] Number of lowering the needle bar by slow operation at start after thread trimming or after data set

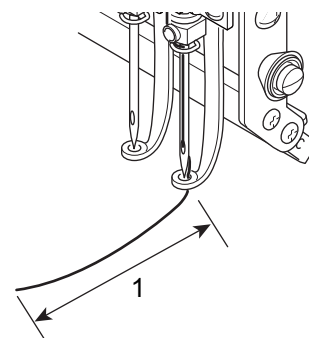

[d] The number of return stitches at start of sewing

When "N" is displayed, the value differs in each needle bar.(→p.108)

The more return stitches are, the less mis-stitching at start decreases.

1:One reciprocation

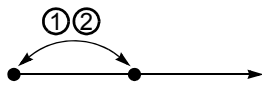

2:Two reciprocations

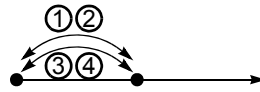

T0:Triangle

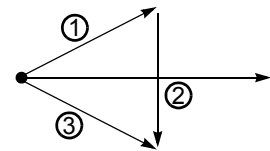

T1:Triangle + one reciprocation

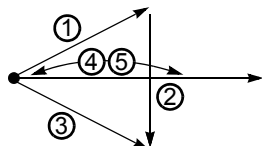

T2:Triangle + two reciprocations

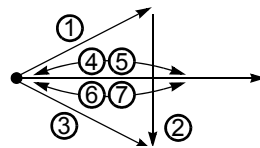

NO:Without Return Stitches

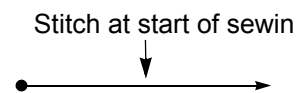

[e] Stitch length of [d] described above

When "N" is displayed, the value differs in each needle bar.(→p.108)

[f] Tie stitching at thread trimming

Setting more tie stitches prevent the thread from pulling out.

A: Not to perform tie stitching

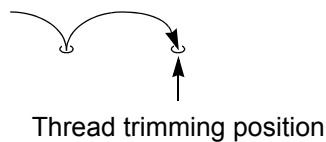

B: To perform tie stitching (once)

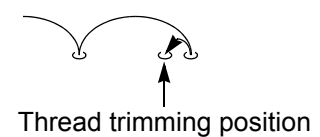

C: To perform tie stitching after lowering the needle twice on the same position at the end of the stitch

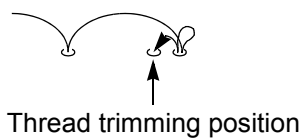

D: To perform tie stitching (twice)

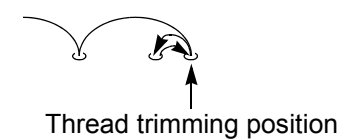

[g] Stitch length of [f] described above

When "N" is displayed, the value differs in each needle bar.(→p.108)

1
2
3
4
5
6
7
8
9
10
11

[h] Coming-out amount of hook (thread holder) (2 in the right figure)

Select B.

A: Short

B: Long

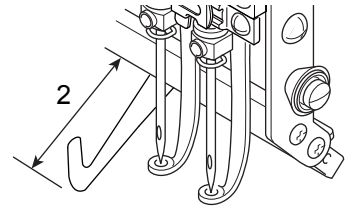

! CAUTION

! Select "B" for hook. Wrong selection would cause abnormal noise and/or not to hold the thread normally.

2-2-2. How to operate

The following is an example that the thread is trimmed automatically, the thread trim length is set to "+2" and inching after ATH is set to "3".

(1) To open screen

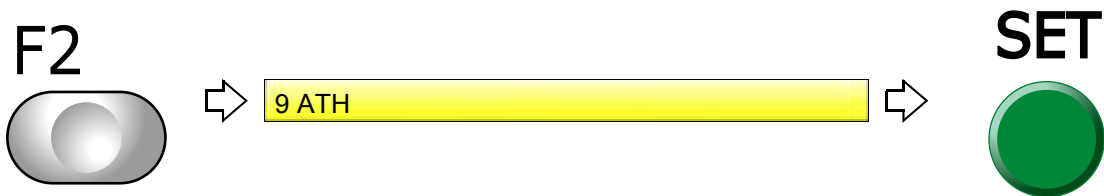

(2) To trim thread automatically



(3) To select thread trim length

When "N" is displayed, changing "N" to a value will set the detecting sensitivity in all needle bars to the same.

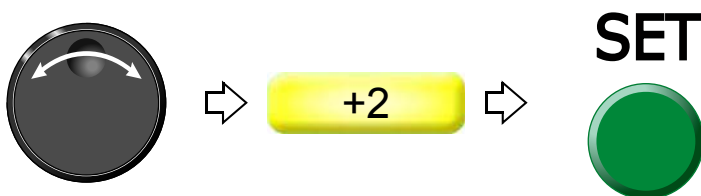

(4) To select number of inching times at start after ATH



2-3. To change thread breakage detecting sensitivity (Thread Detection)

Use this function in the following cases.

- (1) Thread breakage is detected even when thread is not broken.
- (2) Thread breakage detection timing is late.

2-3-1. Screen

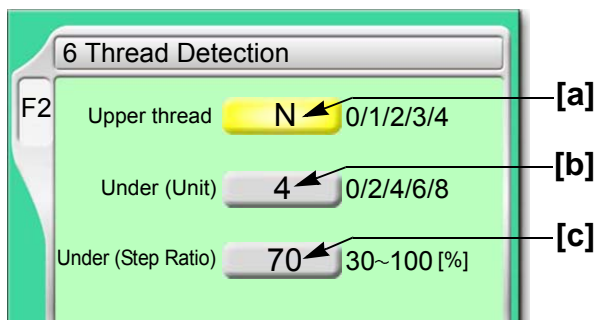

[a] Setting how many consecutive detections of upper thread breakage are regarded as thread breakage

0: Not to stop even if upper thread breaks

When idling the machine, set "Upper" and "Under (Unit)" to "0".

N: To stop if upper thread is broken (the detecting sensitivity differs in each needle bar)
(→p.108)

1, 2, 3, 4: To stop if upper thread is broken (Detecting sensitivity is the same in all needle bar)
When selecting "3", the thread breakage will be detected after upper thread breaks three times continuously.

The relationship between the number of detecting times and sensitivity is shown as follows.

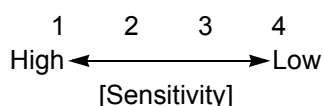

[b] Setting how many consecutive times of detection of "Under (Step Ratio)" of [c] are regarded as thread breakage to stop the machine

0: Not to stop even if under thread is broken

When idling the machine, set "Upper" and "Under (Unit)" to "0".

N: To stop if under thread is broken (the detecting sensitivity differs in each needle bar)
(→p.108)

2, 4, 6, 8: To stop if under thread is broken (Detecting sensitivity is same in all needle bar)
When selecting "4", the thread breakage will be detected after under thread breaks four times continuously.

The relationship between the number of detecting times and sensitivity is shown as follows.

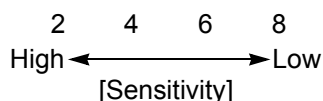

[c] Set sensitivity of [b]. Change this value according to the type of fabric and thread to use. It enables to prevent mis-detection.

N: To stop if under thread is broken (the detecting sensitivity differs in each needle bar)
 (→p.108)

30 to 100: To stop if under thread is broken (Detecting sensitivity is same in all needle bar)

The relationship between detecting ratio and sensitivity is shown as follows.

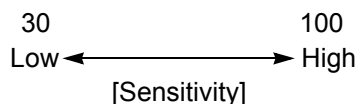

2-3-2. How to operate

The following is an example that the number of upper thread breakage detecting times is set to "2" and the number of under thread breakage detecting times (unit) is set to "6".

(1) To open screen

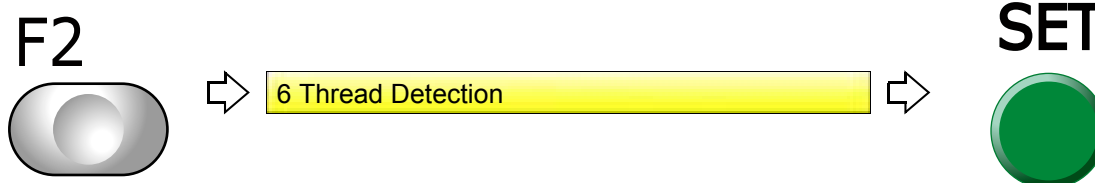

(2) To select the number of upper thread breakage detecting times

When "N" is displayed, changing "N" to a value will set the detecting sensitivity in all needle bars to the same.

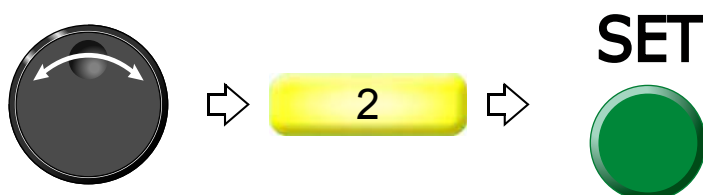

(3) To select number of under thread breakage detecting times (unit)

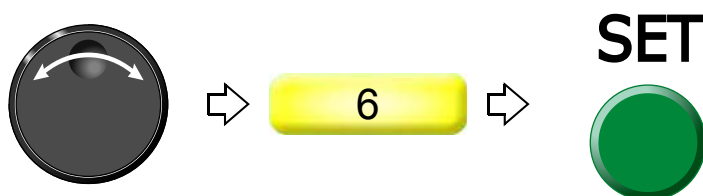

2-4. To trim thread by the number of consecutive jump stitches (Jump Convert)

This function can be used to perform thread trimming in the middle of stitching and moving of the frame to the next stitch by specifying the number of jump code without editing the design.

2-4-1. Screen

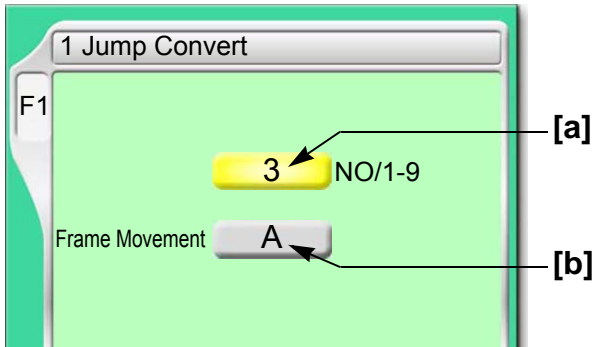

[a] Number of consecutive jump codes

NO: Not effected

1 to 9: Number of consecutive jump codes

[b] How to move frame to next stitch

A: Batch

B: As data

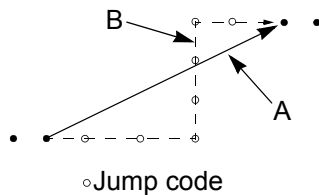

2-4-2. How to operate

The following is an example that the number of consecutive jump code is set to "4".

(1) To open screen

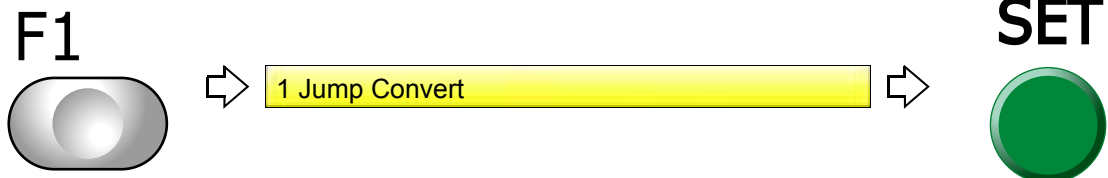

(2) To select number of consecutive jump codes

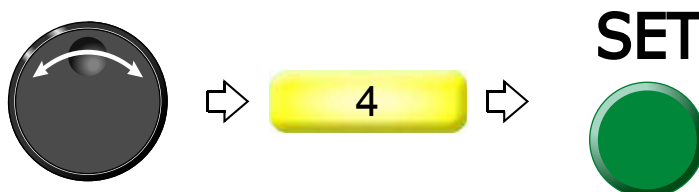

2-5. To add thread trimming code to the design and trim thread (Data Edit "Insert")

This function always executes automatic thread trimming at the same position by adding thread trimming code to the design. A stitch will be inserted before the selected stitch No. When this operation is performed in the middle of embroidery, data set will be canceled. If the stitch with a length length is inserted, a design will be displaced hereafter.

2-5-1. Screen

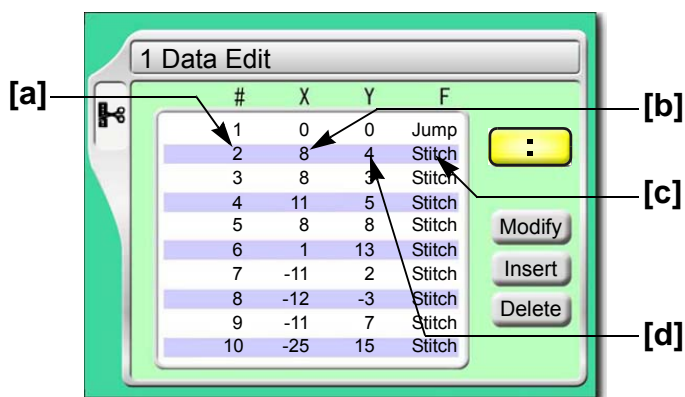

[a] Stitch No.

[b] X data (Data to move the frame in X-axis direction)

When the value is 8, the frame travel amount is 0.8 mm.

[c] Function Code(→p.243)

It is the code to indicate the role of the stitch.

[d] Y data (Data to move the frame in Y-axis direction)

When the value is 4, the frame travel amount is 0.4 mm.

2-5-2. How to operate



CAUTION

 The original design will be overwritten after editing. Back up design data according to need.

The following is an example that thread trimming code is added to 20th stitch.

(1) To open screen

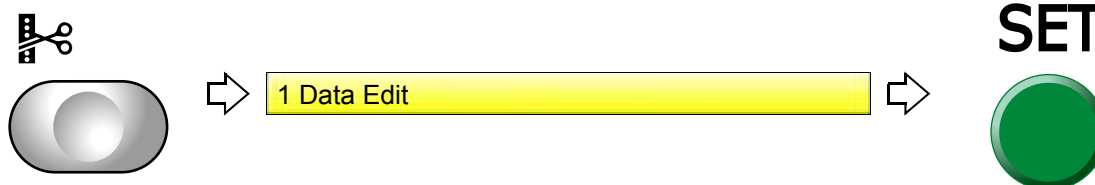

(2) To select a design



(3) To select stitch No. to perform thread trimming



(4) To select "Insert" and decide

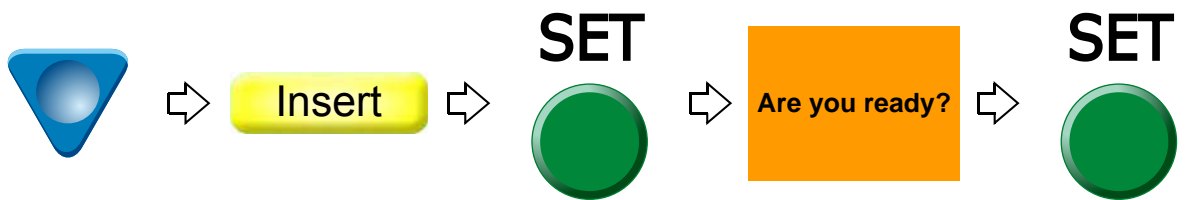

(5) To select "Modify" to move the cursor

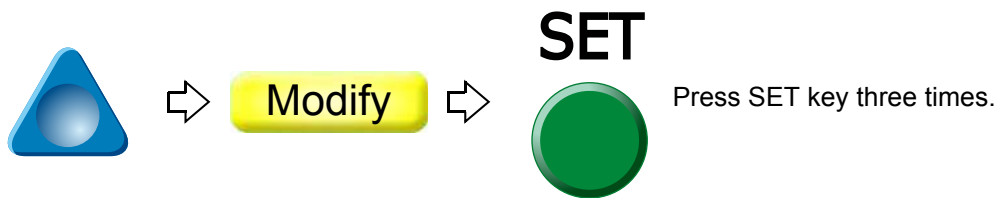

(6) To select "ATH"



(7) To decide

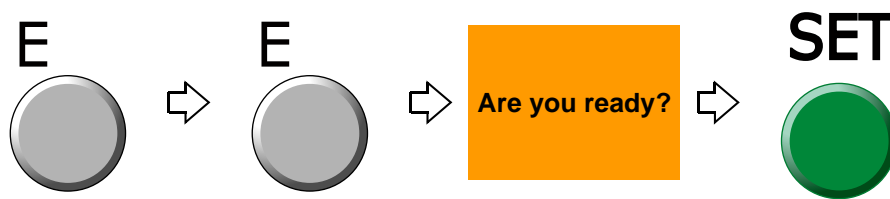

1
2
3
4
5
6
7
8
9
10
11

2-6. To change thread trim timing (ATH Start Timing)

This function applies to TFMX-C, TWMX-C only. Its purpose is to improve thread trimming by changing moving timing of the thread trimming knife.

2-6-1. Screen



2-6-2. How to operate

⚠ CAUTION

⚠ This machine was shipped after being set to optimum values. To change these values, consult the distributor. Some operating condition could cause occurrence of fault in thread trimming.

The following is an example that ATH drive start timing is set to "5 degree".

- (1) Set to main screen.
- (2) Press F2 key while pressing SET key.

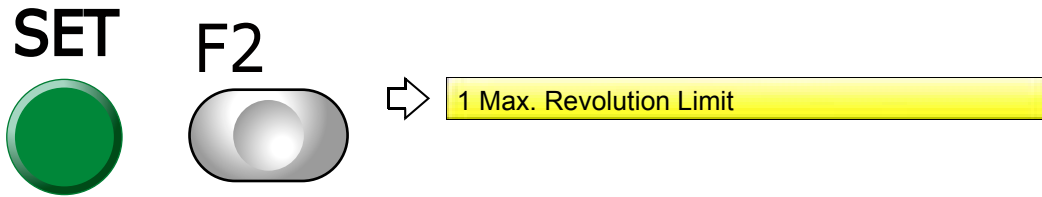

- (3) Press F2 key.



- (4) To select ATH drive start timing

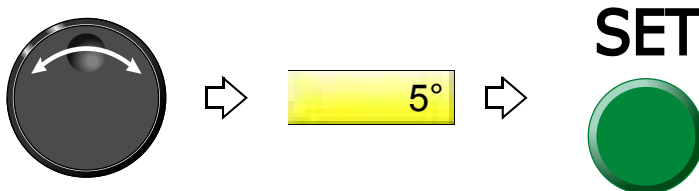

3. To set the embroidery speed

3-1. To limit embroidery speed by stitch length (Min. Revolution)

3-1-1. Screen



↑
Maximum speed at stitch of which stitch length
12.0 mm or more

3-1-2. How to operate

The following is an example that Low Speed R.P.M. is set to "550 rpm".

(1) To open screen

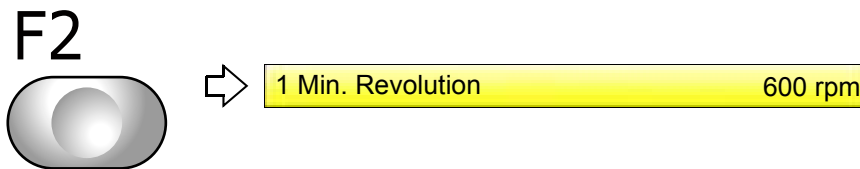

(2) To select Low speed R.P.M.

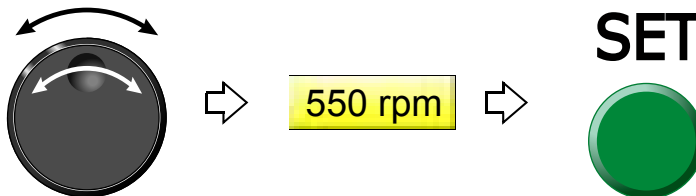

1
2
3
4
5
6
7
8
9
10
11

3-2. To set embroidery speed within speed limit section (Revolution limit)

Set the maximum speed of the section where the embroidery speed is restricted. The area where speed was restricted in the design is surrounded by the following function code.

Function Name	Function Code
Low Speed Start Stitch	Low_S
Low Speed End Stitch	Low_E

3-2-1. Screen

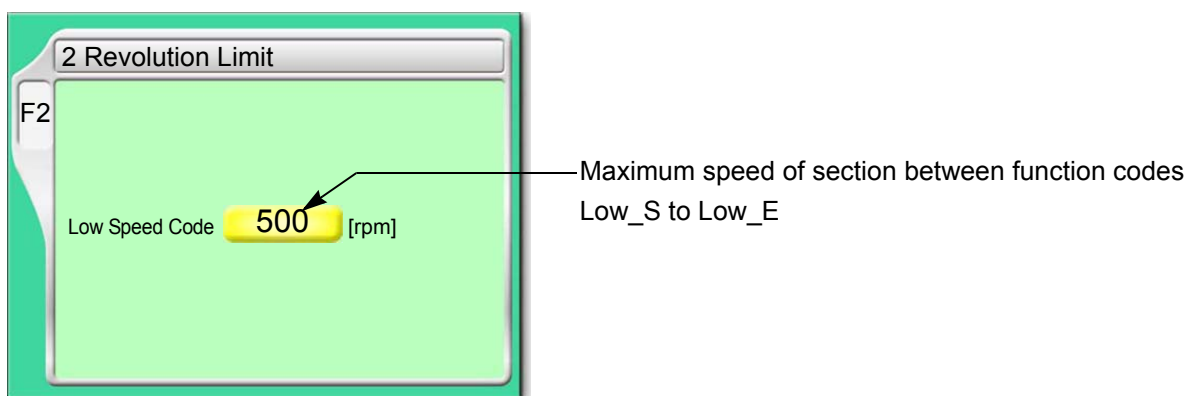

3-2-2. How to operate

The following is an example that the maximum speed of the section between the function codes Low_S to Low_E is set to "700".

(1) To open screen

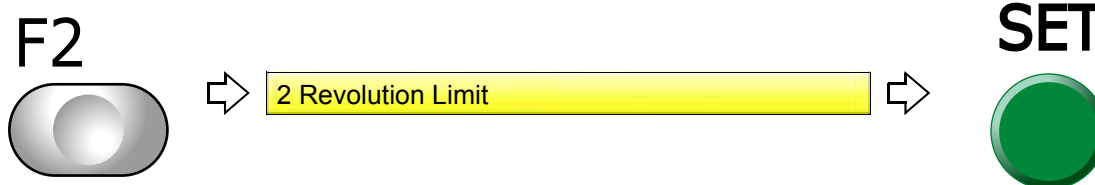

(2) To select maximum speed



3-3. To decide upper limit value of the maximum speed (Max. Revolution Limit)

3-3-1. Explanation on the screen

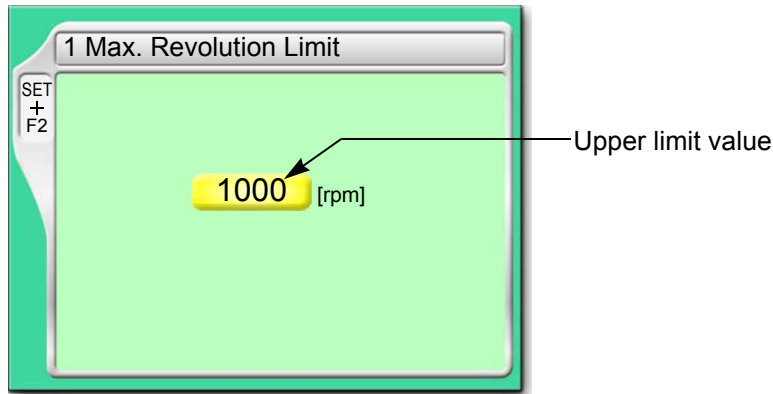

3-3-2. How to operate

The following is an example that Max. Revolution Limit is set to "950".

- (1) Set to main screen.
- (2) To press F2 key while pressing SET, and press SET further

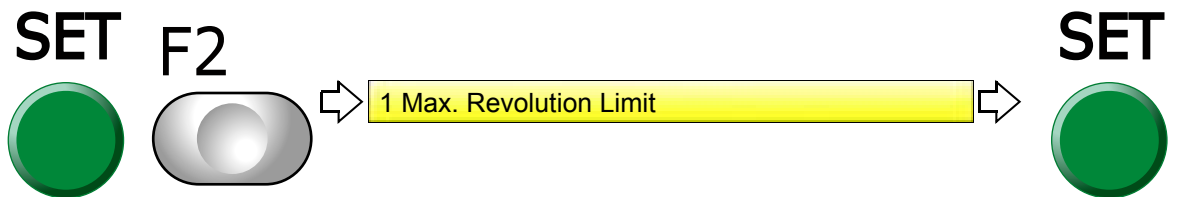

- (3) To cancel the password
Regarding canceling method, refer to the detail page.(→p.135)

- (4) To select limit of max revolution



4. To stop the machine

4-1. To stop the machine automatically when reaching the set value (Preset Halt)

4-1-1. Explanation on the screen

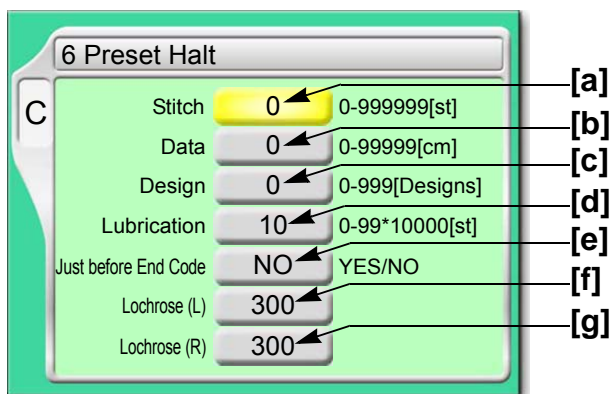

- [a]** The machine will stop when counting reaches the number of the set stitches. (Display of 1D2)
- [b]** The machine will stop when embroidery stitch length reaches the set length (display of 1D2).
- [c]** The machine will stop when the number of designs reaches the set numbers. (Display of 1D2).
- [d]** The machine will stop when counting reaches the number of set stitches. (Display of OIL)
When automatic lubrication system is set to "YES", it will not be displayed.
- [e]** The machine will stop short of the end code by one stitch (display of 1D2).
YES: To stop
Since embroidery is not finished, it is possible to perform frame back.
NO: Not to stop
- [f]** Quantity of beads attached to Lochrose embroidery device (option) at left
When the equipped beads run out, the machine stops (display of 1D5).
To disable this function, select "NO". This setting will be displayed when "Lochrose embroidery device" is set as "L" or "L + R". (→p.194)
- [g]** Quantity of beads attached to Lochrose embroidery device (option) at right
The contents are same as above.

4-1-2. How to operate

The following is an example that the halt by the number of stitch is set to "15000".

(1) To open screen

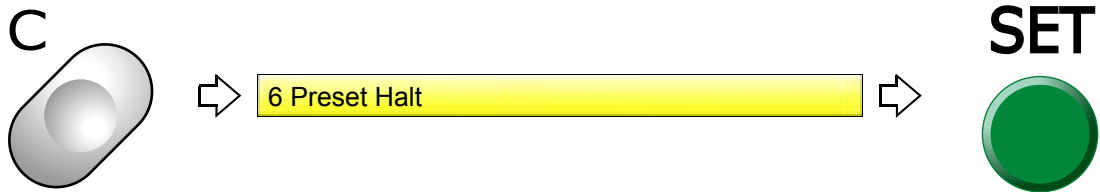

(2) To select value of halt by number of stitch



4-2. To stop the machine before needle bar hits the frame (Software Frame Limit)

4-2-1. Screen

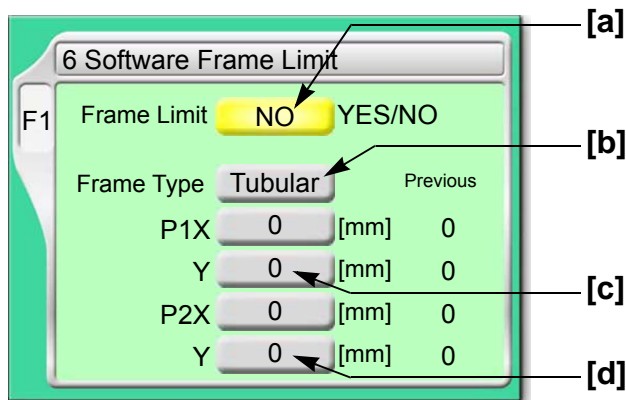

[a] Software Frame Limit

YES: To set / NO: Not to set

[b] "Frame Type" selected now. It is impossible to change. Software Frame Limit is memorized in every frame type.

[c] Frame coordinates of Point 1(→p.94)

[d] Frame coordinates of Point 2(→p.94)

4-2-2. How to operate

! CAUTION

⊘ When performing this operation, do not put your hands etc. on the machine table. Moving frame could injure you.

The following is an example that the tubular frame is set as Software Frame Limit.

(1) To open screen

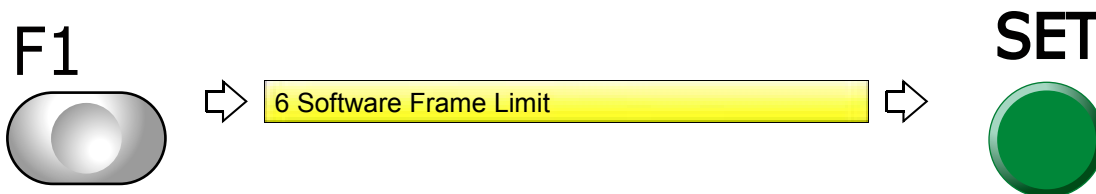

(2) To make software frame limit effective



(3) To decide P1 (Point 1)

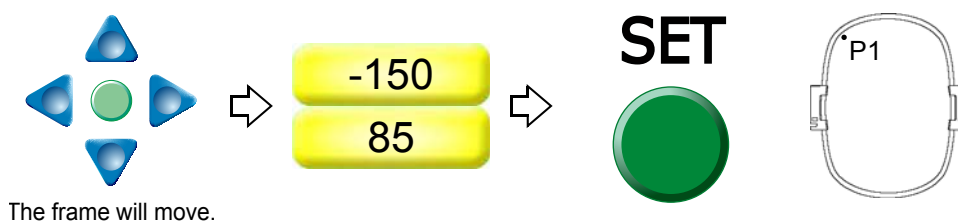

(4) To decide P2 (Point 2)

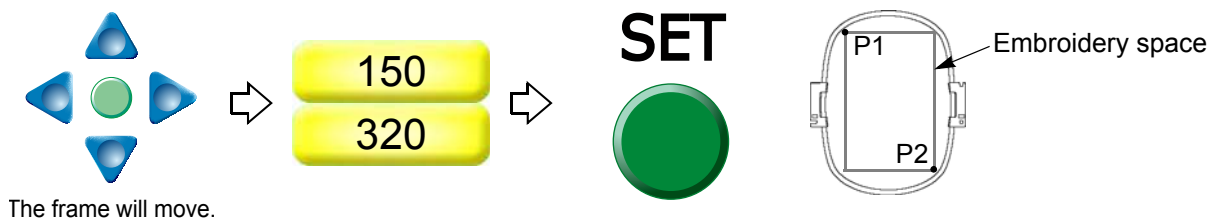

4-3. To stop the machine with needle bar stuck in the material (Stop at Lower D.Point)

This setting stop the machine with needle stuck in the material at the end of embroidery. This function is effective for embroidering to consecutive design using AFC (option) mainly.

4-3-1. Screen

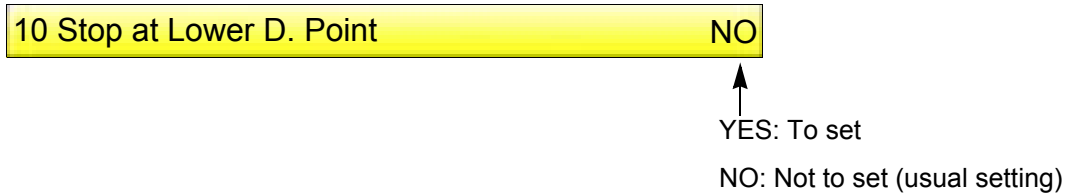

4-3-2. How to operate

The following is an example that Stop at Lower D. Point is set.

(1) To open screen

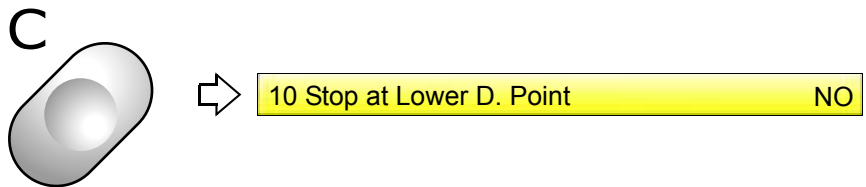

(2) To set Stop at Lower D. Point



1
2
3
4
5
6
7
8
9
10
11

4-4. To stop at Frame Limit (Frame Limit setting)

This is the setting to stop the frame at Flame Limit (movable limit position). To stop at Frame Limit, it is necessary to be memorized the frame origin correctly by the machine. The position where the frame stops differs in every "Frame Type". This function is not applicable for L-spec. machine.

4-4-1. Screen



Stop at Frame Limit

YES: To stop (usual setting)

NO: Not to stop

Selecting "NO" will not display the following message at data input.

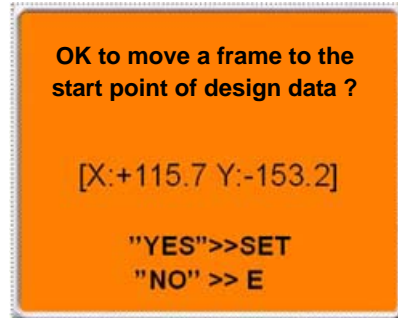

4-4-2. How to operate

⚠ CAUTION

! Selecting "NO" will not stop the frame at frame limit. The frame could interfere with the peripheral part resulting in its breakage.

The following is an example that the frame is stopped at Frame Limit.

- (1) Set to main screen.
- (2) To press F1 key while pressing SET

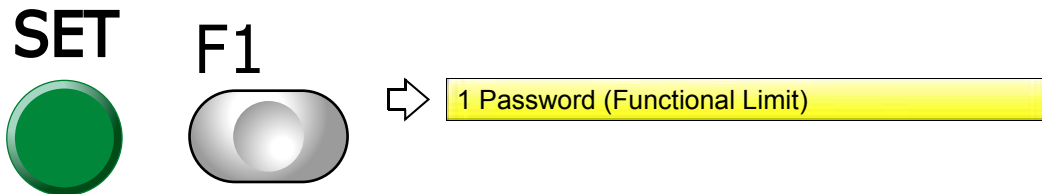

(3) To press F1 key

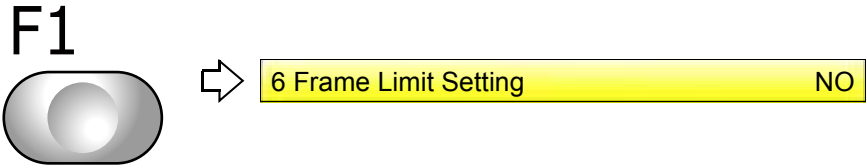

(4) To make Frame Limit setting effective



1
2
3
4
5
6
7
8
9
10
11

5. To change the direction and the size of the design

5-1. To perform enlargement, rotation, reversion (Data Conversion)

Set this function after data set. Setting contents here will be added in a design. So, when you embroider this design next time, setting again will be unnecessary.

5-1-1. Screen

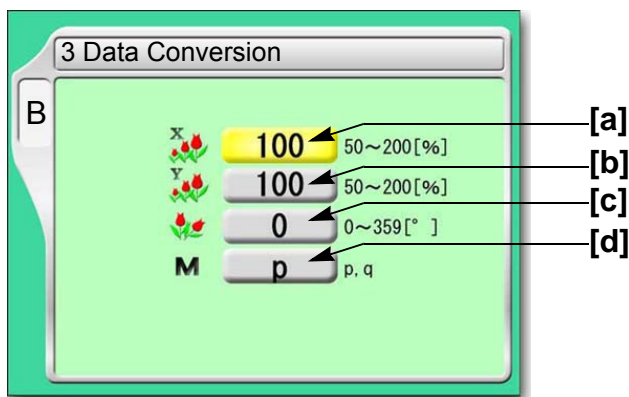

[a] Horizontal (X) scale ratio (%)

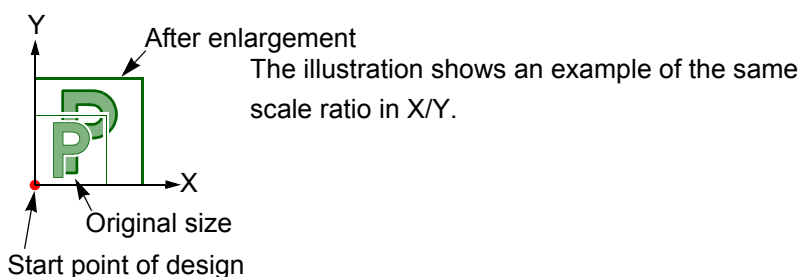

[b] Vertical (Y) scale ratio (%)

[c] Rotating angle (°)

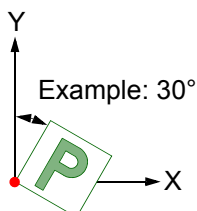

[d] Reverse

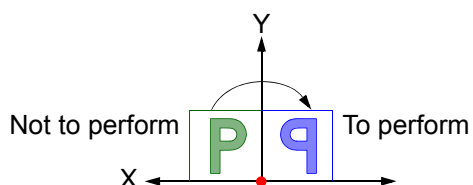

5-1-2. How to operate

The following is an example that horizontal scale ratio and vertical scale ratio are set to "120".

(1) To open screen

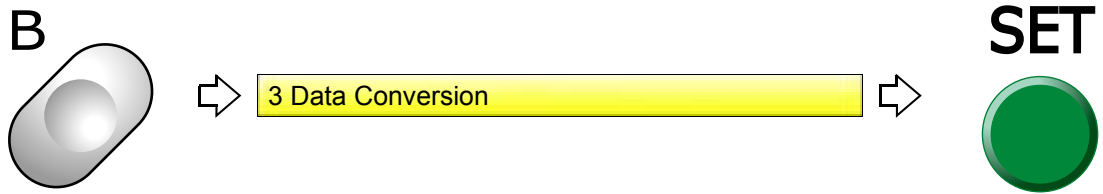

(2) To select horizontal scale ratio



(3) To select vertical scale ratio



1
2
3
4
5
6
7
8
9
10
11

6. To embroider the same design repeatedly

6-1. To repeat to horizontal and vertical direction (Repeat)

Set this function after data set. Setting contents here will be added in a design. So, when you embroider this design next time, setting again will be unnecessary.

6-1-1. Explanation on the screen

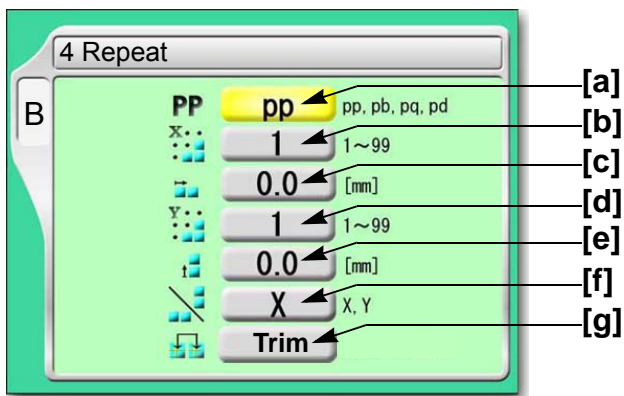

[a] Repeat method

The illustration below is an example that the priority embroidery direction is vertical.

[In case of pp]

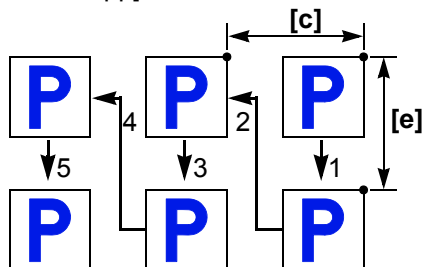

[In case of pq]

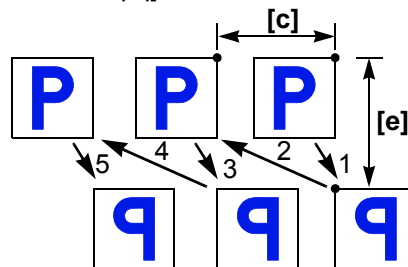

[In case of pb]

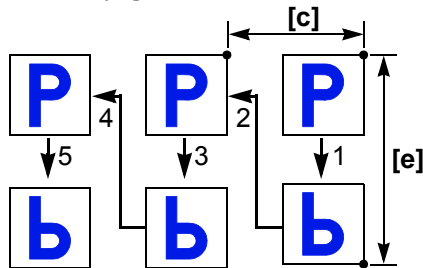

[In case of pd]

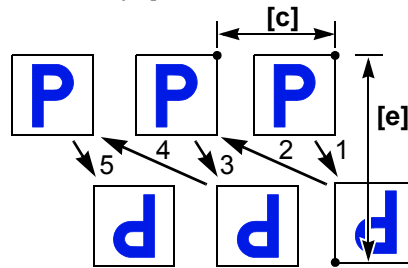

[b] Number of repeats in horizontal

[c] Interval in horizontal (mm)

Repeat direction will be decided by code.
 Selecting "-" will perform embroidering at left repeatedly.

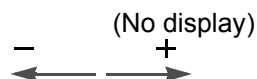

[d] Number of repeats in vertical

[e] Interval in vertical (mm)

Repeat direction will be decided by code. Selecting "-" will perform embroidering at front.

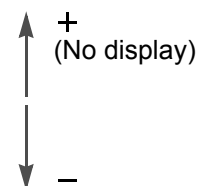

[f] Priority embroidering direction (horizontal/vertical)

It is the setting which direction is given priority to embroider, horizontal(X) or vertical(Y).

[g] To embroider the next design after thread trimming

It is displayed only and cannot be changed.

6-1-2. How to operate

⚠ CAUTION

⊘ When performing this operation, do not put your hands etc. on the machine table. Moving frame could injure you.

The following is an example that repeat pattern "pb", the number of repeats in horizontal "3", interval in horizontal "-60", the number of repeats in vertical "2", interval in vertical "-50", priority direction "X" are set.

(1) To open screen

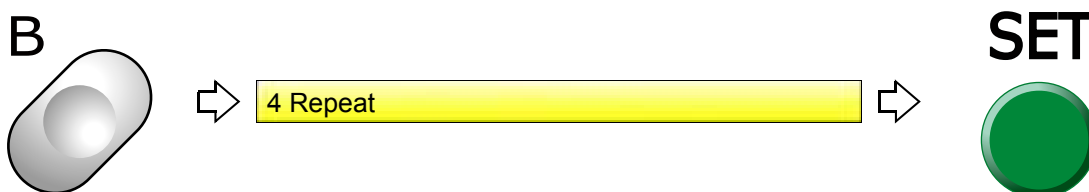

(2) To select repeat pattern

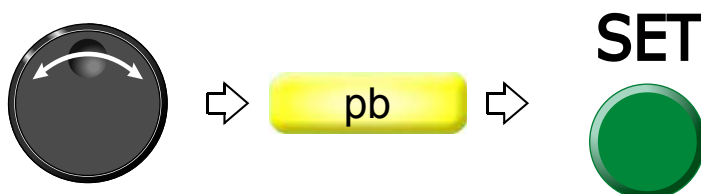

(3) To select number of repeats in horizontal



(4) To select interval in horizontal (mm)

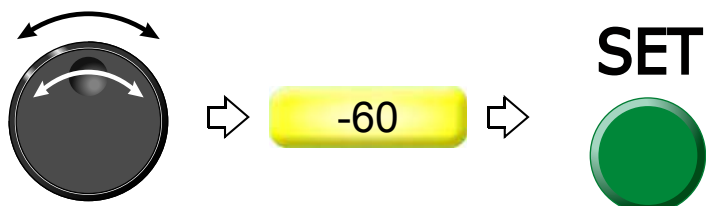

The frame will move.

(5) To select number of repeats in vertical

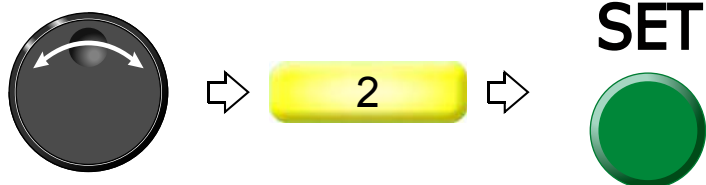

(6) To select interval in vertical (mm)



The frame will move.

(7) To select priority embroidering direction

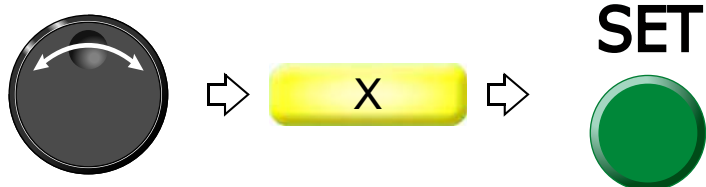

After that, switching the screen will return the frame to the original position.

To cancel the setting of repeat, set "the number of repeats in horizontal" and "the number of repeats in vertical" to "1".

6-2. To repeat at the same place (A.S. after Auto Data Set)

This setting makes the machine start automatically after finishing embroidery and embroider the same design repeatedly.

This function is effective only when "Auto Start (AS)" is set to "YES".(→p.55)

6-2-1. Screen



↑
YES: To set
NO: Not to set (usual setting)

6-2-2. How to operate



The following is an example that Automatic Start after Automatic Data Set is set.

(1) To open screen

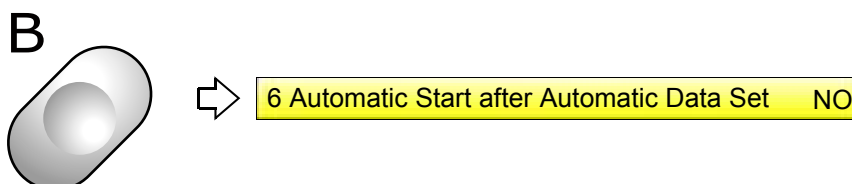

(2) To set automatic start after automatic data set



7. To adjust finishing of embroidering

7-1. To adjust driving error of the frame (Backlash)

This function corrects error of finished stitching generated by Backlash. Backlash means the play generated by the shock in the parts at the drive system or around the frame when return stitches are executed.

7-1-1. Explanation on the screen

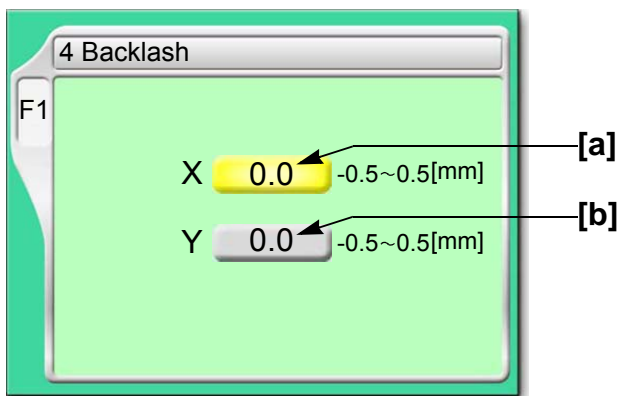

[a] Correcting value in horizontal

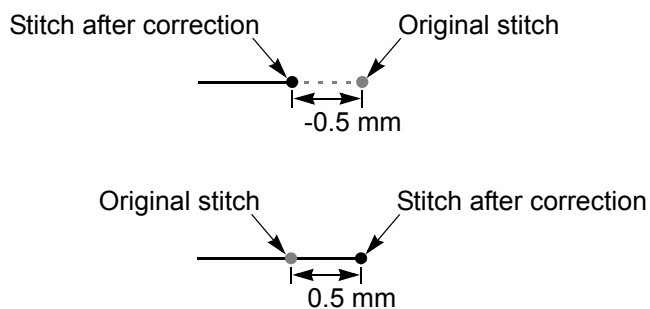

[b] Correcting value in vertical

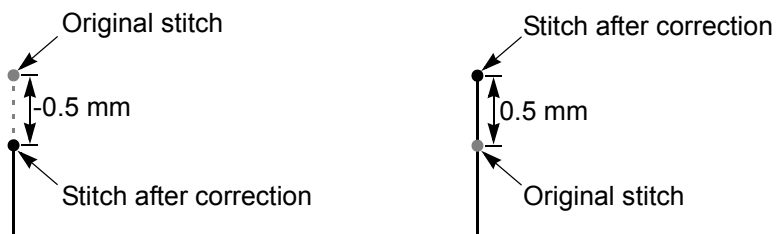

[Example of combination of X/Y correcting value]

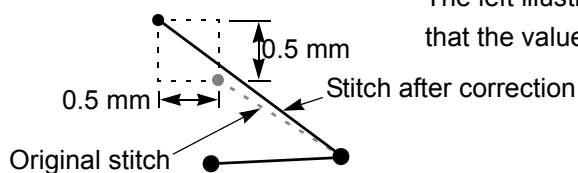

The left illustration shows an example that the values are X:0.5 and Y:0.5.

7-1-2. How to operate

The following is an example that correcting value of horizontal direction is set to "0.3".

(1) To open screen

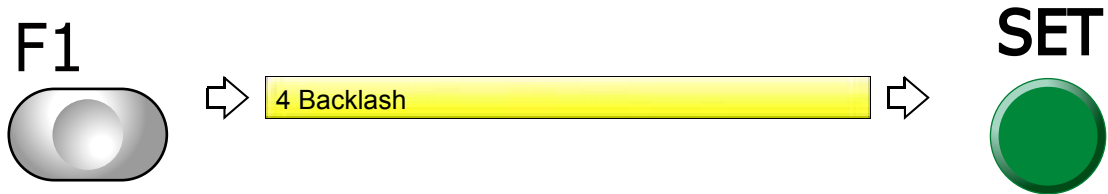

(2) To select correcting value in horizontal

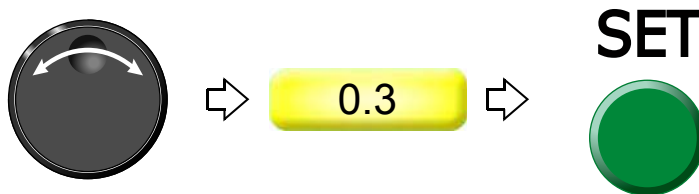

7-2. To adjust stitch length of satin stitch (Satin Stitch)

7-2-1. Screen

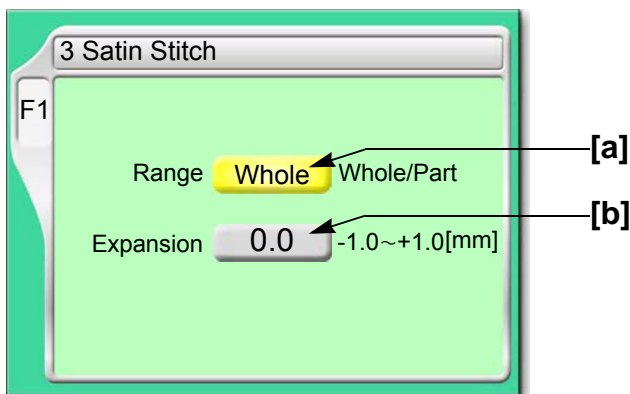

[a] Applicable range

Whole: All satin stitches in the design are targets.

Part:

Satin stitches of the section surrounded by satin stitch codes (Satin_S to Satin_E) are targets. It is necessary to add the satin stitch code if it is not in the design.

[b] Adding amount

1/2 of the value will be added to both sides of stitch length.

Example of the value in +0.4 mm

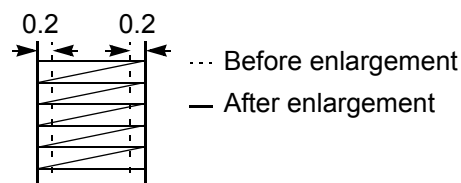

7-2-2. How to operate

The following is an example that applicable range is set to "part" and expansion amount is set to "+0.4".

(1) To open screen

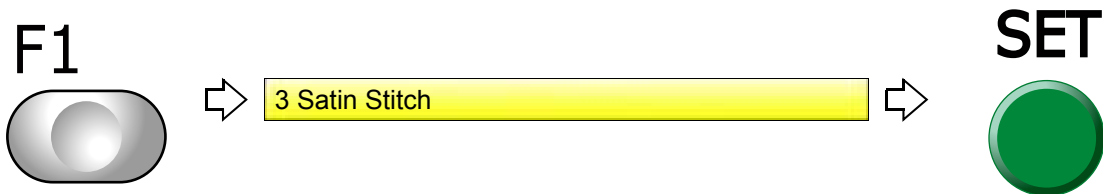

(2) To select applicable range

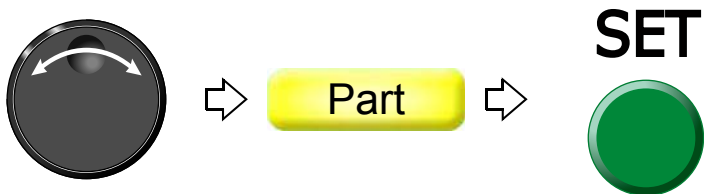

(3) To select adding amount



7-3. To divide a long stitch (Auto Jump)

This function makes the frame movement to divide by jump automatically when a stitch length exceeds a setting value. This function reduces the load generated at the frame drive due to heavy weight of the material to be embroidered. However, dividing by jump will reduce embroidering efficiency.

7-3-1. Explanation on the screen

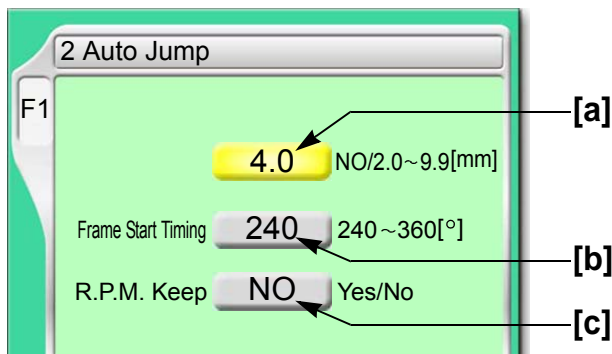

[a] Setting for auto jump

NO: Not to perform

2.0 to 9.9:

The machine will jump automatically when a stitch exceeding a set value is given. When a value is 4.0, the machine will jump automatically if stitches of 4.1 mm and more are given. When the setting of frame type is set to "Auto Clamp Frame", setting range is 2.0 to 5.0 mm.

[b] Timing to start moving the frame(→p.113)

[c] R.P.M. at auto jump

YES: To keep (remaining in high speed)

NO: Not to keep (speed reduction according to a stitch length)

7-3-2. How to operate

The following is an example that stitch length to jump automatically is set to "6.0".

(1) To open screen

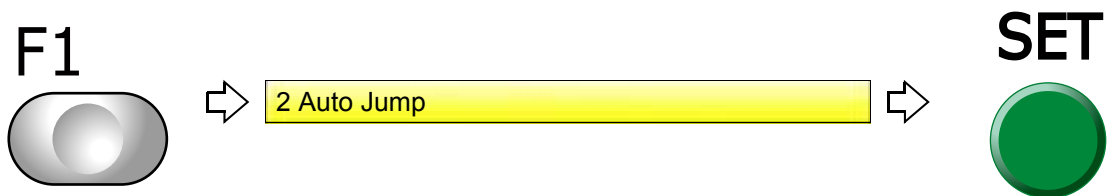

(2) To select stitch length to perform automatic jump

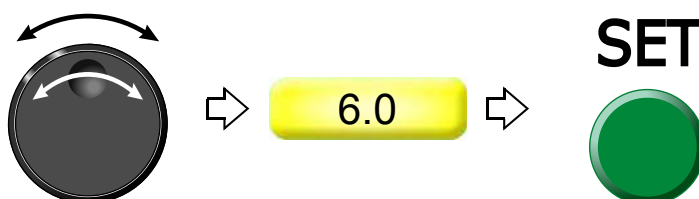

7-4. To change stitching condition in every needle bar (Setting in units of Needle bar)

7-4-1. Explanation on the screen

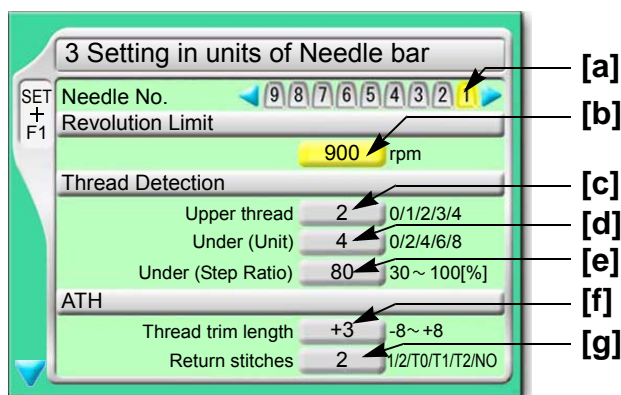

↓ To the next page

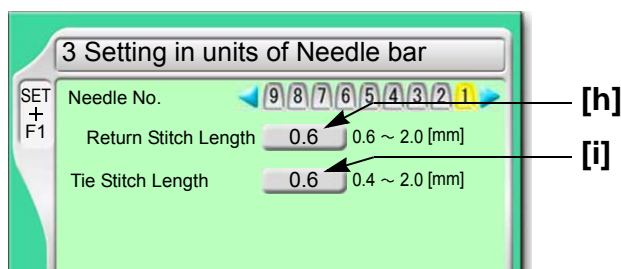

[a] Needle bar No. applied to sewing condition
Perform the following setting for this needle bar.

[b] Maximum speed

[c] Number of upper thread breakage detecting times

Setting how many consecutive detections of upper thread breakage are regarded as thread breakage

0: Not to stop even if upper thread breaks

When idling the machine, set "Upper" and "Under (Unit)" to "0".

1, 2, 3, 4: To stop if upper thread is broken

When selecting "3", the thread breakage will be detected after upper thread breaks three times continuously.

The relationship between the number of detecting times and sensitivity is shown as follows.

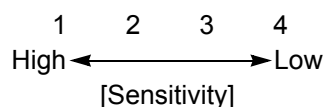

[d] Number of under thread breakage detecting times

Setting how many consecutive times of detection of "under thread (ratio)" of [e] are regarded as thread breakage to stop the machine

0: Not to stop even if under thread is broken

When idling the machine, set "Upper" and "Under (Unit)" to "0".

2, 4, 6, 8: To stop if under thread is broken

When selecting "4", the thread breakage will be detected after under thread breaks four times continuously.

The relationship between the number of detecting times and sensitivity is shown as follows.

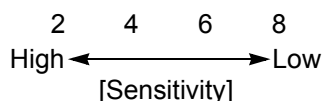

[e] Sensitivity of [d] described above

Set sensitivity of [d]. Change this value according to the type of fabric and thread to use. It enables to prevent mis-detection.

30 to 100: To stop if under thread is broken

The relationship between detecting ratio and sensitivity is shown as follows.

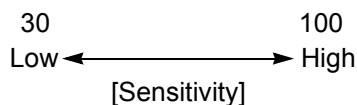

[f] Remaining length of upper thread

Length of remaining upper thread at thread trimming (1 in the right figure)

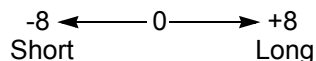

When upper thread remains on the fabric, select the value of "-".

If the thread does not link at the start of sewing due to short of remaining length of upper thread, select the value of "+".

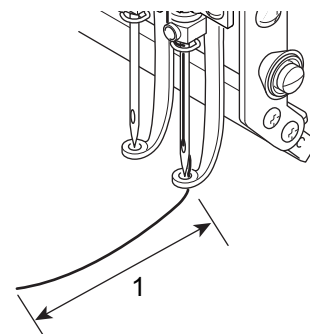

1
2
3
4
5
6
7
8
9
10
11

[g] Return stitches

The number of return stitches at start of sewing

The more return stitches are, the less mis-stitching at start decreases.

1:One reciprocation

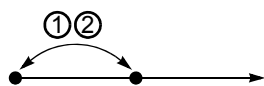

2:Two reciprocations

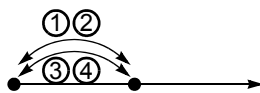

T0:Triangle

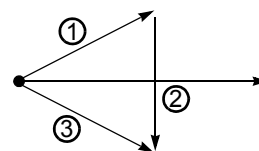

T1:Triangle + one reciprocation

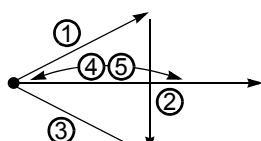

T2:Triangle + two reciprocations

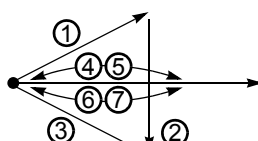

NO:Without Return Stitches

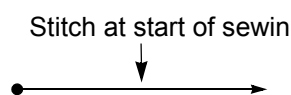

[h] Stitch length of return stitch after start of sewing

[i] Tie stitch length at thread trimming

7-4-2. How to operate

The following is an example that the needle bar No. is set to "3", the maximum speed is set to "950", and the upper thread breakage detecting sensitivity is set to "3".

(1) Set to main screen.

(2) To press F1 key while pressing SET

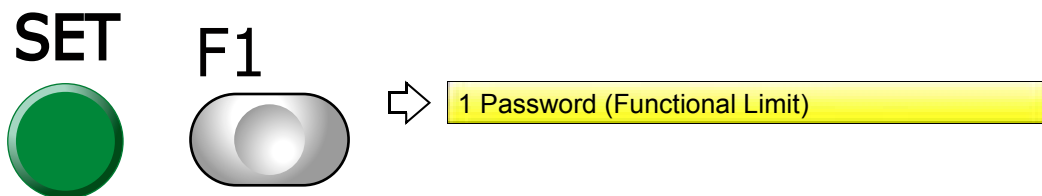

(3) To press F1 key

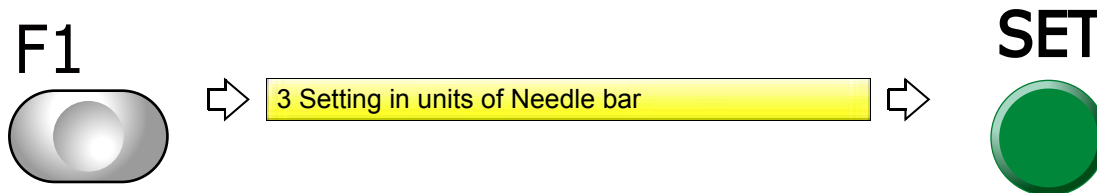

(4) To select the needle bar No.

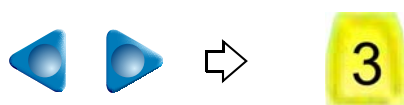

(5) To select maximum speed



(6) To select the number of upper thread breakage detecting times

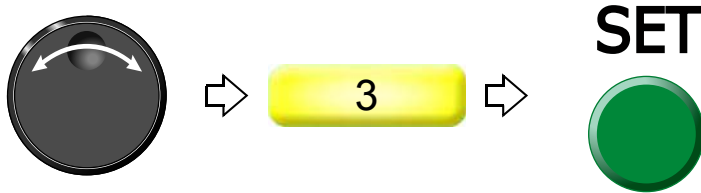

7-5. To delete tiny stitch (Cleanup)

This function removes tiny stitch that causes thread breakage and it is added to the next stitch. This function has an effect to decrease thread breakages.

7-5-1. Screen

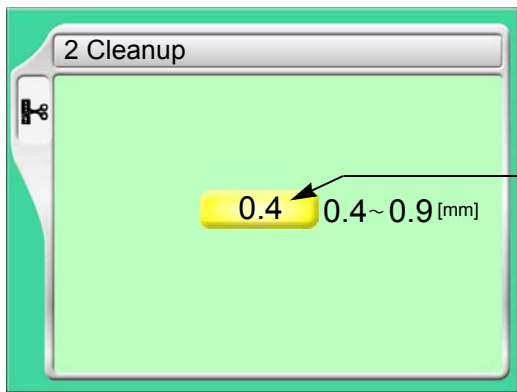

Indicated value or less stitches will be removed.

1
2
3
4
5
6
7
8
9
10
11

7-5-2. How to operate

CAUTION

 The original design will be overwritten after removing fine stitches. Back up design data according to need.

The following is an example that the stitch length to remove is set to "0.5".

(1) To open screen

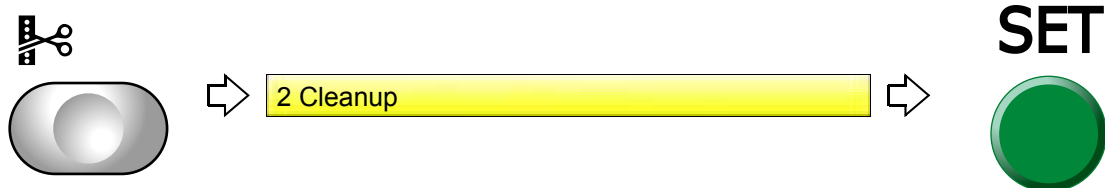

(2) To select a design



(3) To select stitch length to remove, and execute

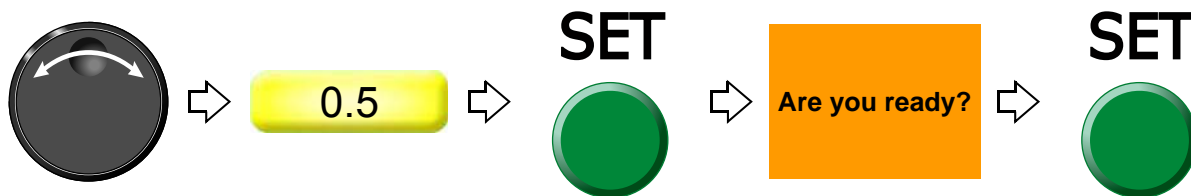

7-6. To change thread tension (Frame Start Timing)

7-6-1. Screen

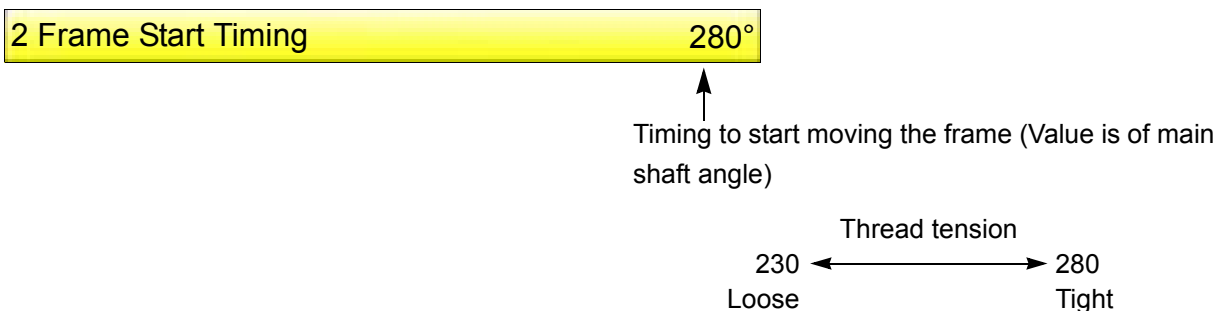

7-6-2. How to operate

CAUTION

To change this value, consult the distributor. Some operating condition could cause occurrence of fault in thread trimming and affect sewing.

The following is an example that Frame Start Timing is set to "270".

- (1) Set to main screen.
- (2) Press F2 key while pressing SET key.

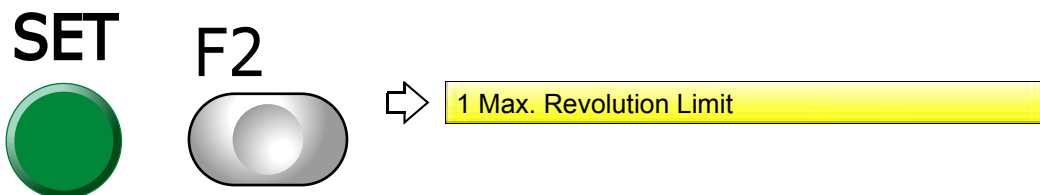

- (3) Press F2 key.

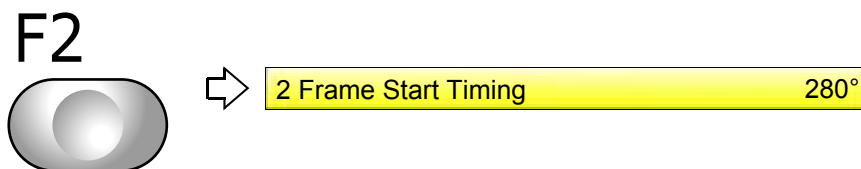

- (4) To select Frame Start Timing

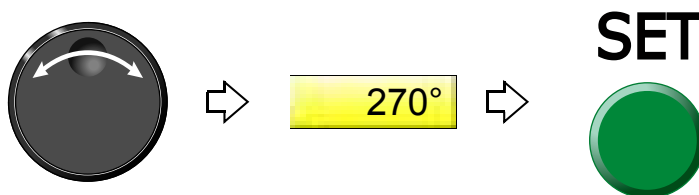

7-7. Not to stand out the edge of upper thread (Upper thread lock timing)

7-7-1. Explanation on the screen

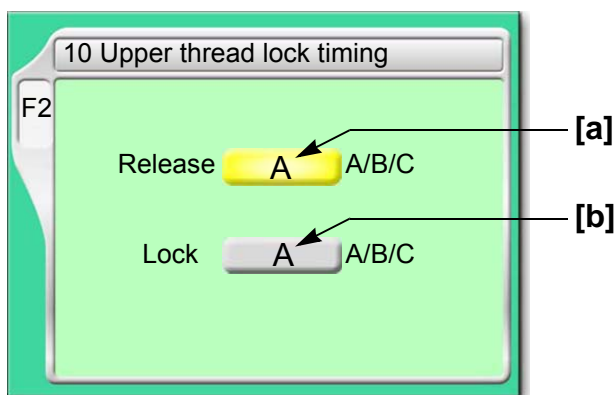

[a] Timing to open upper thread lock

Perform adjustment when the edge of upper thread remains on the fabric after thread trimming. When the edge of upper thread is still highly visible at A, set to B or C.

- A | The edge of upper thread is easy to remain.
- B |
- C | The edge of upper thread is hard to remain.

[b] Timing to close upper thread lock

Perform adjustment when the edge of upper thread remains on the fabric after thread trimming. When the edge of upper thread is still highly visible, set to B or C.

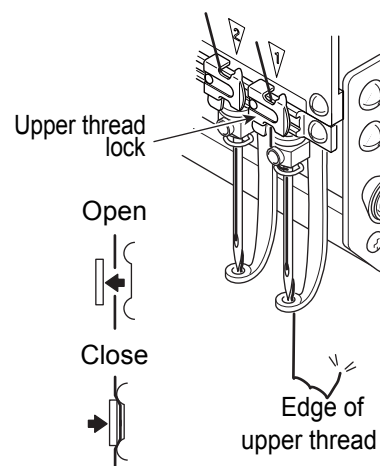

7-7-2. How to operate

The following is an example that remaining length of upper thread is set to "B" after start sewing.

(1) To open screen

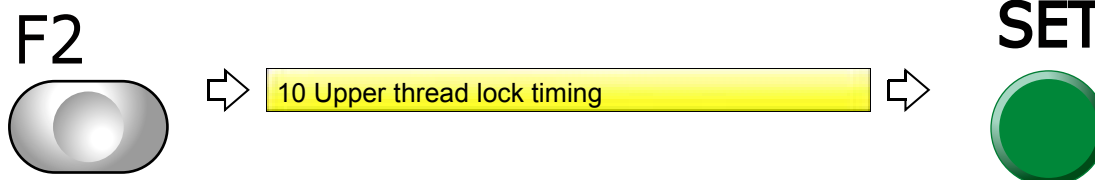

(2) To select remaining length of upper thread after start of sewing

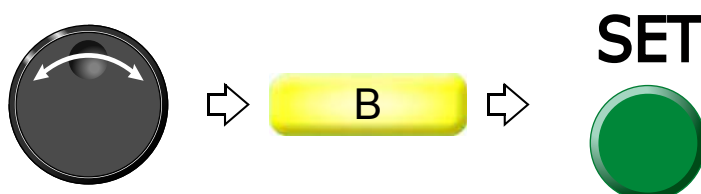

7-8. To adjust stitching length according to a stitch length (Frame Drive Adjustment)

This function applies to 2 or more head machines.

7-8-1. Screen

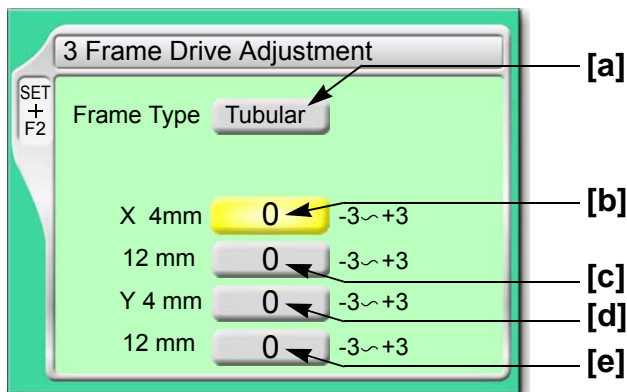

[a] "Frame Type" selected now(→p.152)

The following values can be memorized at every "Frame Type".

[b] To adjust stitch in horizontal direction of around 4 mm finely

Stitch length tends to be increased in [-] value and decreased in [+] value in general due to characteristic of the machine. However, this aptitude may not be applicable depending on setting condition of other items and/or machine condition.

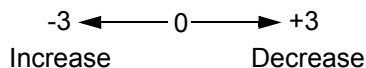

[c] Stitch in crosswise direction of around 12 mm

[d] Stitch in lengthwise direction of around 4 mm

[e] Stitch in lengthwise direction of around 12 mm

7-8-2. How to operate

The following is an example that the stitch in horizontal direction of around 4 mm is set to "+1".

(1) Set to main screen.

(2) Press F2 key while pressing SET key.

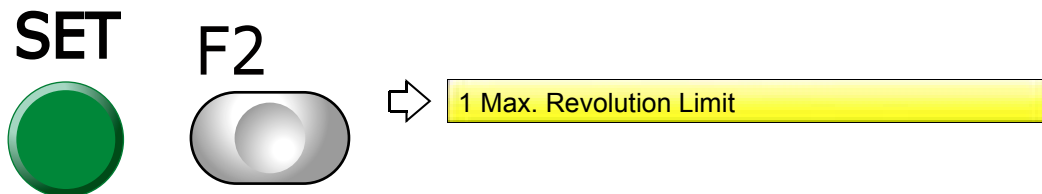

(3) Press F2 key.

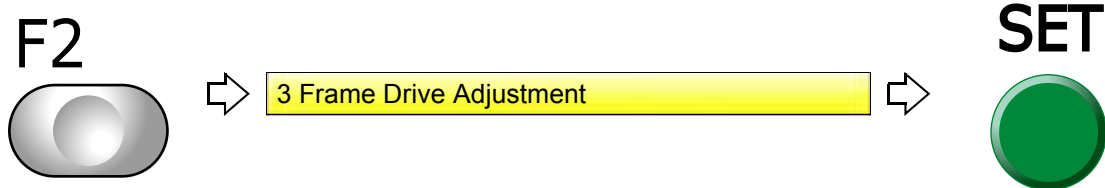

(4) To select stitch in horizontal direction of around 4 mm

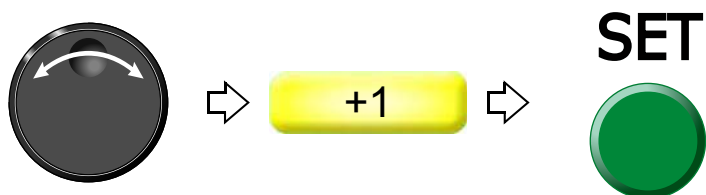

8. To increase embroidering efficiency

8-1. To change number of lowering needle bar at slow operation (Main Shaft Inching)

This function targets slow operation when the machine stops in the middle of embroidery and then the machine restarts. Regarding the number of lowering the needle bar by slow operation at start after thread trimming or after data set, refer to the detail page.(→p.80)

8-1-1. Screen

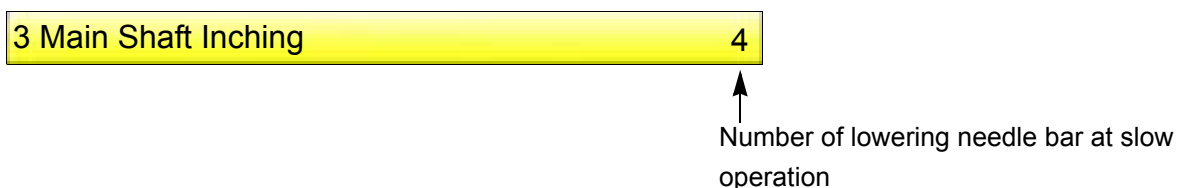

8-1-2. How to operate

The following is an example that the number of Start Inching is set to "3".

(1) To open screen

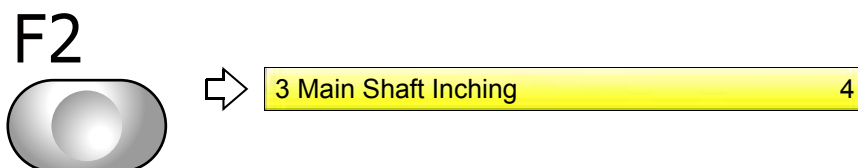

(2) To select number of lowering needle bar at slow operation

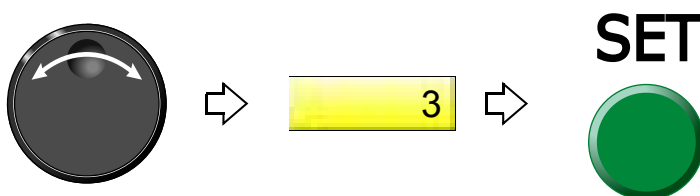

8-2. To collect up frame moving amount of consecutive jump stitches in a batch to feed the frame all at once (Jump code combination)

This function reduces the number of stitches by combining frame moving amount of consecutive jump stitches (up to 5 stitches) and by feeding the frame all at once.

8-2-1. Screen

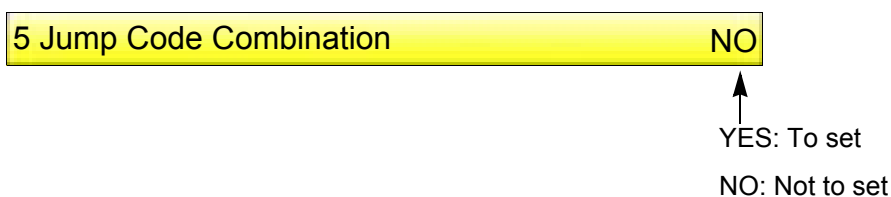

8-2-2. How to operate

The following is an example that Jump Code Combination is set.

(1) To open screen

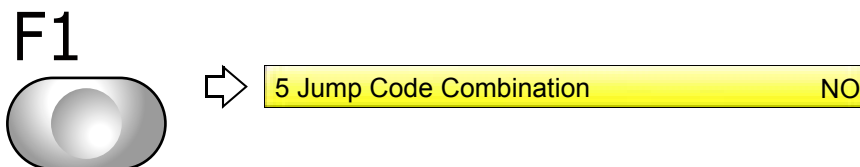

(2) To set Jump Code Combination

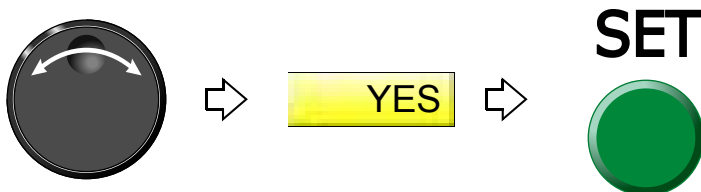

8-3. To change moving speed of needle bar case (Color change speed)

This function applies to TFMX-C, TWMX-C only. When sequin device III is equipped, the machine does not have this function.

8-3-1. Screen

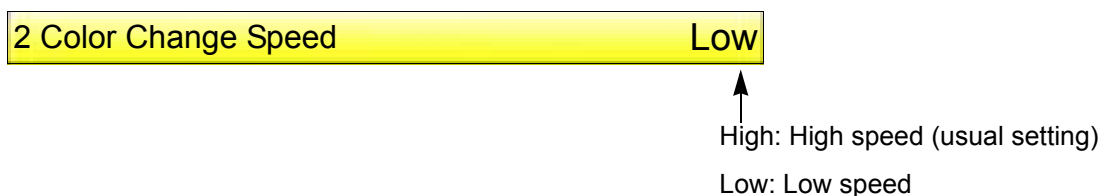

8-3-2. How to operate

The following is an example that Color Change Speed is set to "High".

(1) Press the F5 key within 10 seconds after turning ON the power, and keep on pressing the key. When the window of "F5+PW" starts up, release it.

(2) To select color change speed



8-4. To change travel speed of the frame (Frame Travel Speed)

This function targets at origin return of the frame and/or offset travel.

8-4-1. Screen

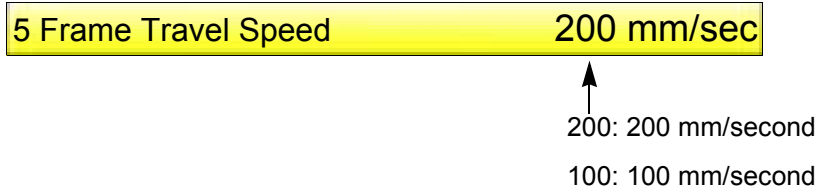

8-4-2. How to operate

The following is an example that Frame Travel Speed is set to 100 mm/sec".

(1) To open screen

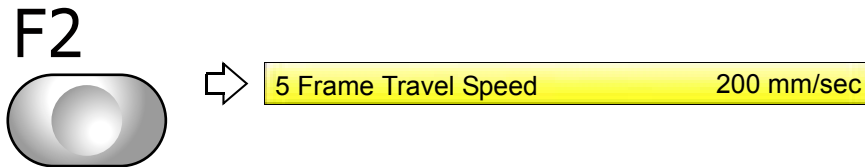

(2) To select Frame Travel speed



1
2
3
4
5
6
7
8
9
10
11

8-5. To set data of the design automatically after the embroidery is finished (Automatic Data Set after finishing embroidery)

This function corresponds to TFMX-C, TWMX-C only.

8-5-1. Screen

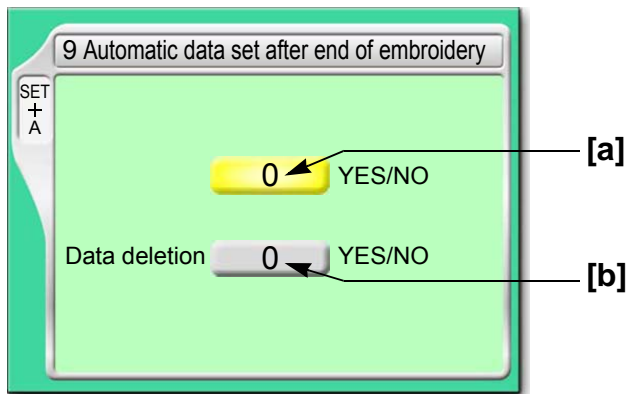

[a] Perform Automatic Data Set of the design embroidered after finishing the embroidery.

YES: To perform

NO: Not to perform

[b] Delete the design automatically after finishing the embroidery.

It is selectable only when [a] is set to NO.

YES: To perform

NO: Not to perform

8-5-2. How to operate

The following is the example of "Not to perform Automatic Data Set of the design" and "Delete the design automatically" after finishing the embroidery.

(1) Set to main screen.

(2) To press A key while pressing SET key

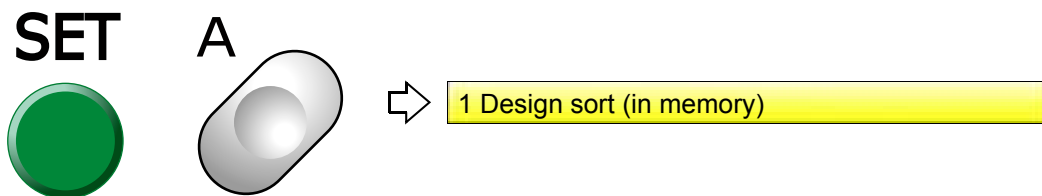

(3) To press A key

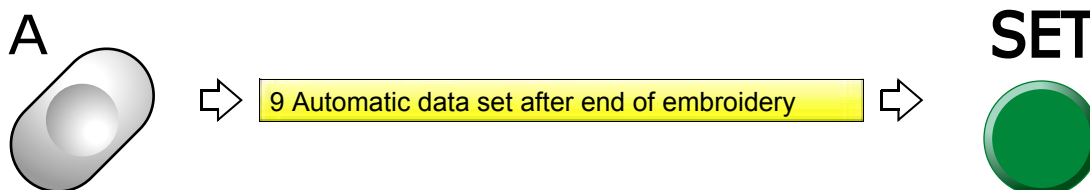

(4) To select NO (Not to perform Automatic Data Set of the design)



(5) To select YES (Delete the design automatically)



1
2
3
4
5
6
7
8
9
10
11

9. To edit design

9-1. To modify the stitch (Data Edit "Modify")

When this operation is performed in the middle of embroidery, data set will be canceled. If stitch length after change is different from that before change, a design will displace hereafter.

9-1-1. Screen

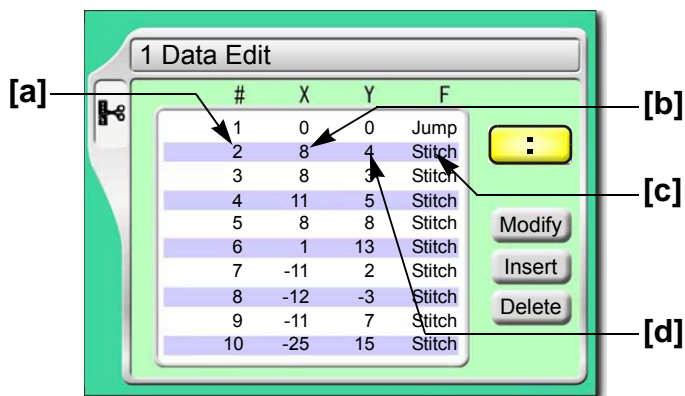

[a] Stitch No.

[b] X data (Data to move the frame in X-axis direction)

When the value is 8, the frame travel amount is 0.8 mm.

[c] Function Code(→p.243)

It is the code to indicate the role of the stitch.

[d] Y data (Data to move the frame in Y-axis direction)

When the value is 4, the frame travel amount is 0.4 mm.

9-1-2. How to operate

CAUTION

The original design will be overwritten after editing. Back up design data according to need.

The following is an example that 20th stitch is changed to non-data (X: 0.0, Y:0.0) jump code.

(1) To open screen

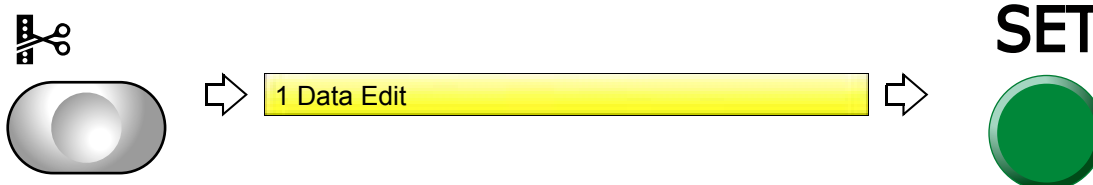

(2) To select a design



After that, select the stitch No. to change. There are following two types of selecting patterns.

(a) To select stitch No. by using search function, refer to the detail page.(→p.124)

(b) To select the stitch No. by the jog dial/jog shuttle, follow the explanation below.

[To select stitch No. by using the jog dial/jog shuttle]

(3) To select stitch No. to change

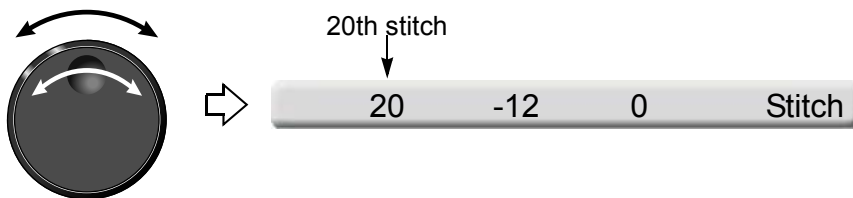

(4) To select "Modify"



(5) To edit X data

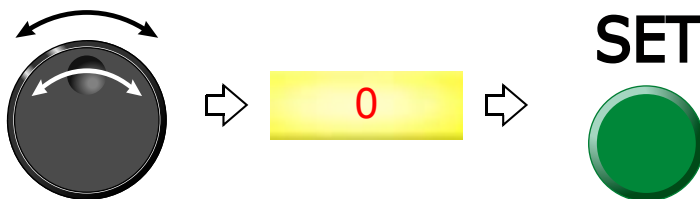

(6) To edit Y data

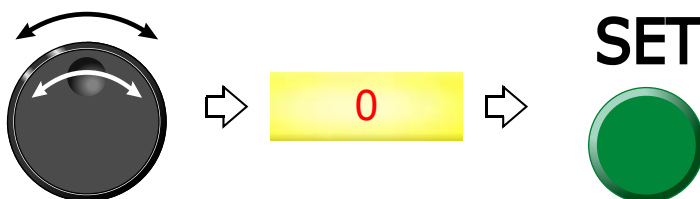

1
2
3
4
5
6
7
8
9
10
11

(7) To modify the function code



(8) Decide the modification.

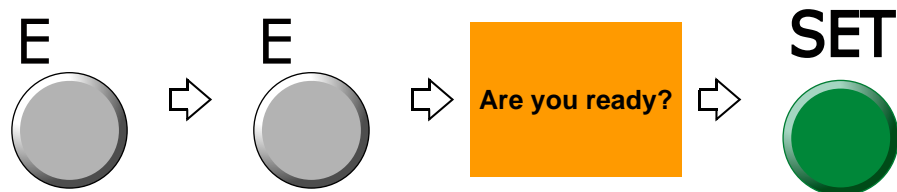

[To select stitch No. by using search function]

(3) To make search function effective

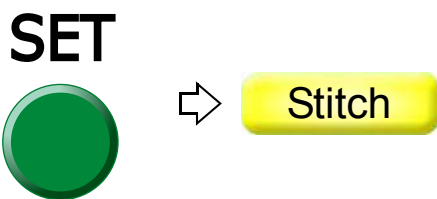

(4) To search stitch by function code



Pressing SET key will search the stitch including a function code "Color". Pressing SET key further will search the next stitch.

When there is no selected function code, display will not change.

(5) To complete the search and select "Modify"

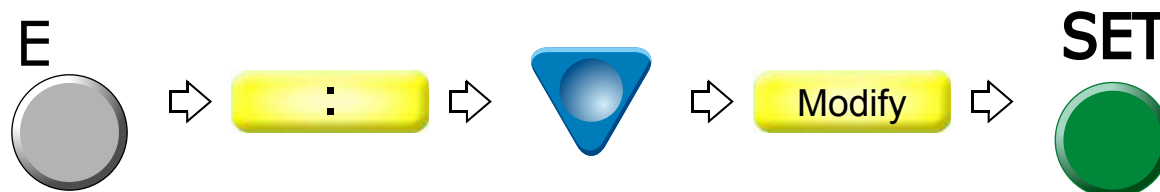

(6) To edit X data

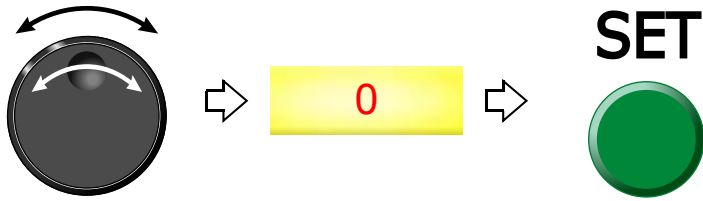

(7) To edit Y data

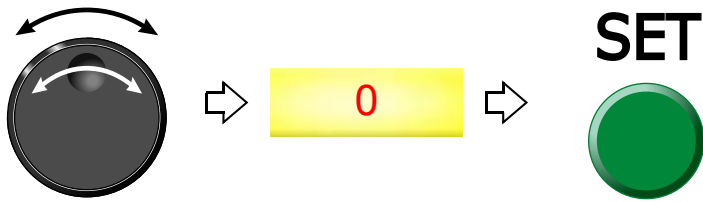

(8) To modify the function code



(9) Decide the modification.

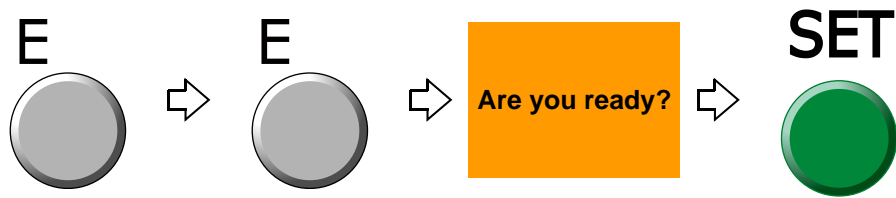

1
2
3
4
5
6
7
8
9
10
11

9-2. To insert the stitch (Data Edit "Insert")

When this operation is performed in the middle of embroidery, data set will be canceled. If the stitch with a length is inserted, a design will be displaced hereafter.

9-2-1. Screen

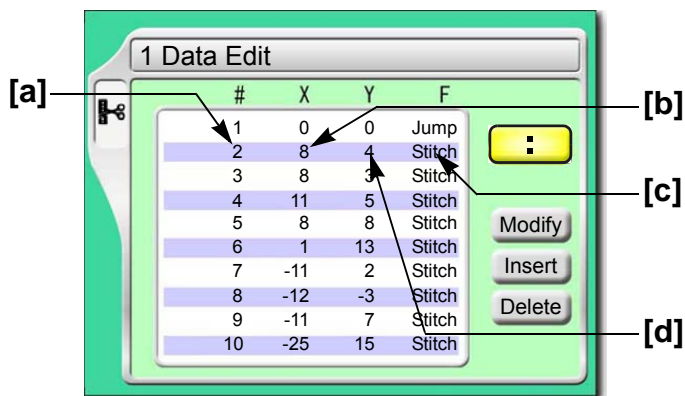

[a] Stitch No.

[b] X data (Data to move the frame in X-axis direction)

When the value is 8, the frame travel amount is 0.8 mm.

[c] Function Code(→p.243)

It is the code to indicate the role of the stitch.

[d] Y data (Data to move the frame in Y-axis direction)

When the value is 4, the frame travel amount is 0.4 mm.

9-2-2. How to operate

CAUTION

The original design will be overwritten after editing. Back up design data according to need.

The following is an example that non-data (X: 0.0, Y:0.0) jump code is added to 120th stitch.

(1) To open screen

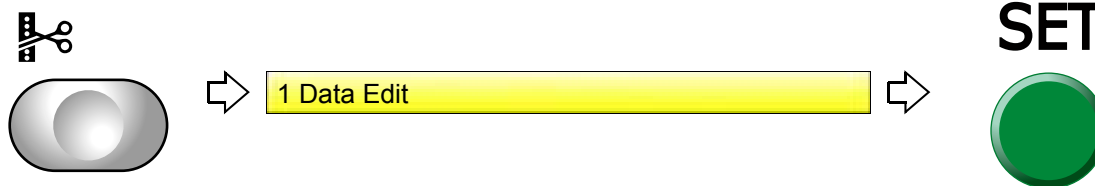

(2) To select a design



After that, select the stitch No. to insert. There are following two types of selecting patterns.

(a) To select stitch No. by using search function, refer to the detail page.(→p.128)

(b) To select the stitch No. by the jog dial/jog shuttle, follow the explanation below.

[To select stitch No. by using the jog dial/jog shuttle]

(3) To select stitch No. to insert

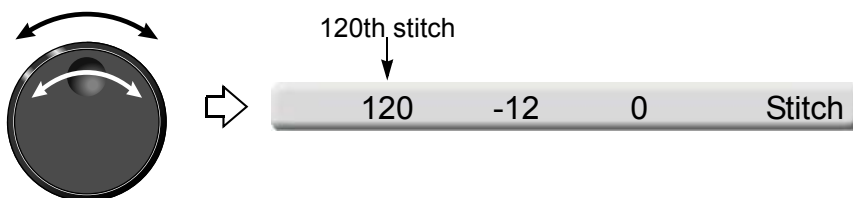

(4) To select "Insert"



(5) To execute insertion



(6) To select "Modify" to move the cursor

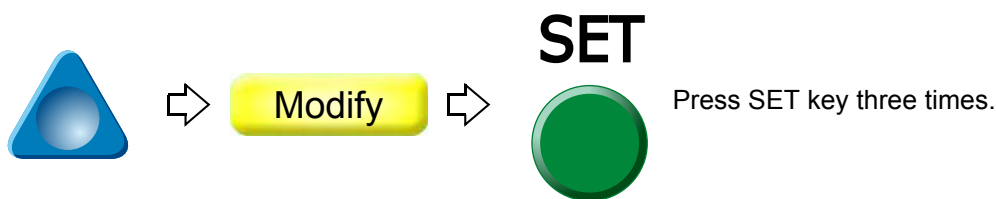

1
2
3
4
5
6
7
8
9
10
11

(7) To select "Jump".



(8) To decide insertion

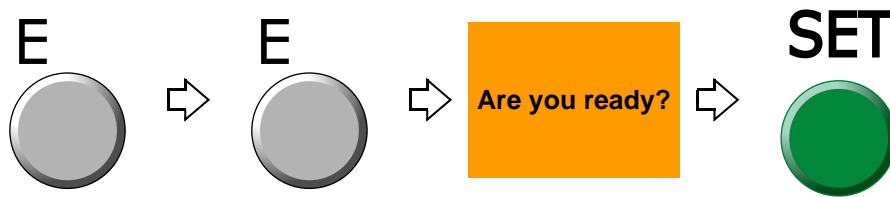

[To select stitch No. by using search function]

(3) To make search function effective

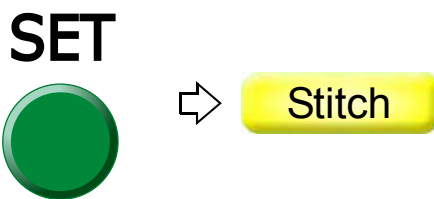

(4) To search stitch by function code

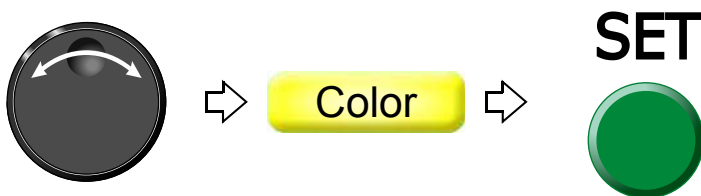

Pressing SET key will search the stitch including a function code "Color". Pressing SET key further will search the next stitch.

When there is no selected function code, display will not change.

(5) To complete the search and select "Insert"

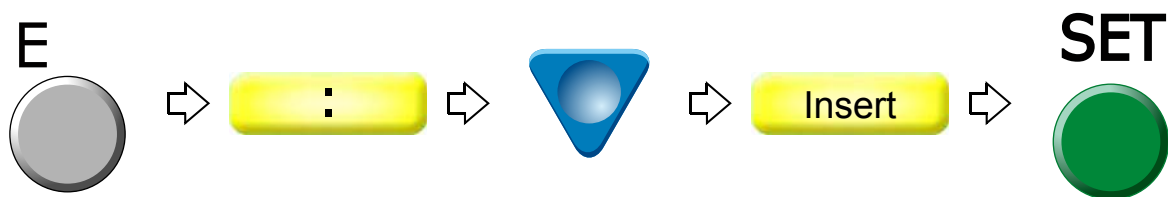

(6) To execute insertion



(7) To select "Modify" to move the cursor

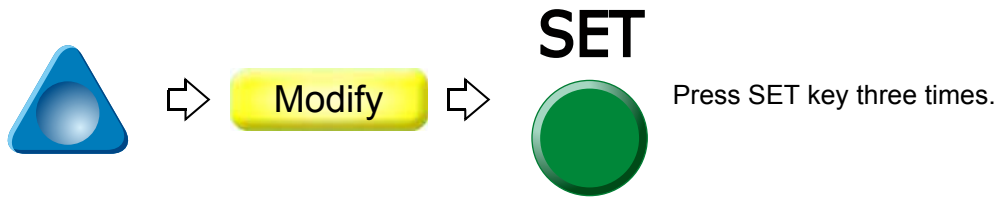

(8) To select "Jump".



(9) To decide insertion

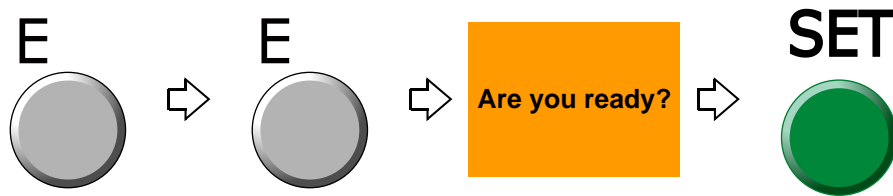

1
2
3
4
5
6
7
8
9
10
11

9-3. To delete the stitch (Data Edit "Delete")

When this operation is performed in the middle of embroidery, data set will be canceled. If the stitch having length is deleted, a design will displace hereafter.

9-3-1. Explanation on the screen

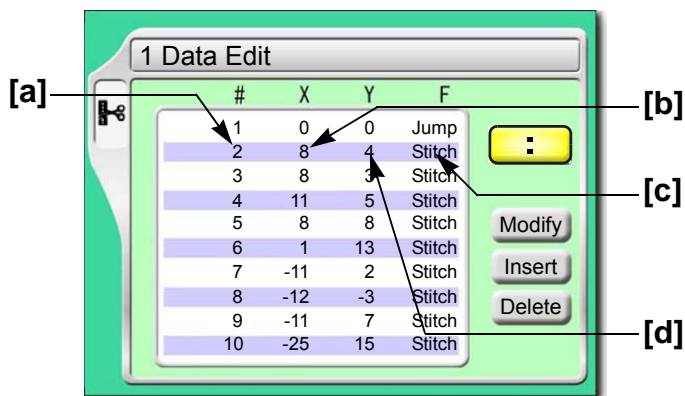

[a] Stitch No.

[b] X data (Data to move the frame in X-axis direction)

When the value is 8, the frame travel amount is 0.8 mm.

[c] Function Code(→p.243)

It is the code to indicate the role of the stitch.

[d] Y data (Data to move the frame in Y-axis direction)

When the value is 4, the frame travel amount is 0.4 mm.

9-3-2. How to operate

CAUTION

The original design will be overwritten after editing. Back up design data according to need.

The following is an example that 20th stitch is deleted.

(1) To open screen

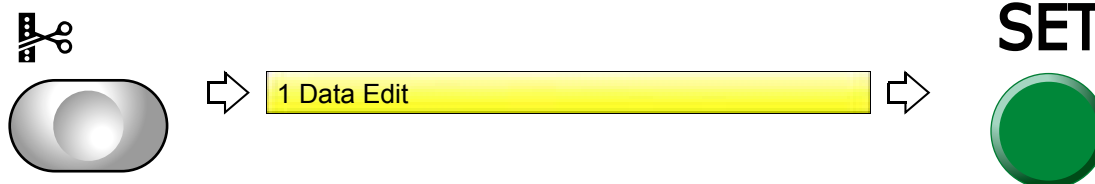

(2) To select a design



After that, select the stitch No. to delete. There are following two types of selecting patterns.

(a) To select stitch No. by using search function, refer to the detail page.(→p.131)

(b) To select the stitch No. by the jog dial/jog shuttle, follow the explanation below.

[To select stitch No. by using the jog dial/jog shuttle]

(3) To select stitch No. to delete

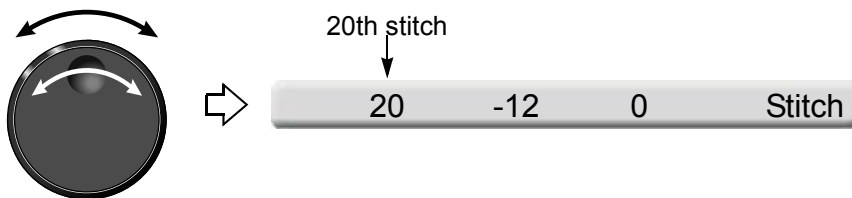

(4) To select "Delete"



(5) To decide deletion



[To select stitch No. by using search function]

(3) To make search function effective

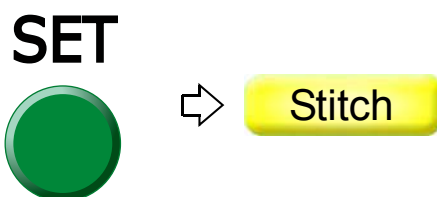

1
2
3
4
5
6
7
8
9
10
11

(4) To search stitch by function code

Pressing SET key will search the stitch including a function code "Color". Pressing SET key further will search the next stitch.

When there is no selected function code, display will not change.

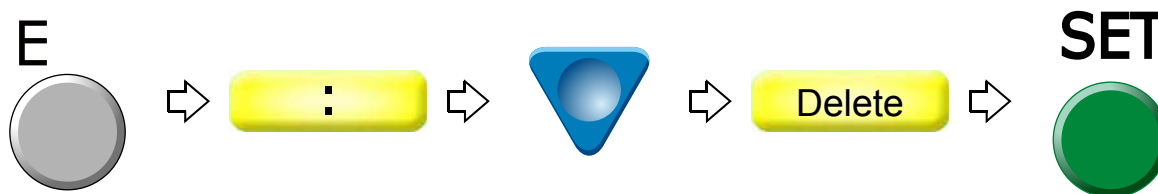
(5) To select "Delete"**(6)** To decide deletion

10. Setting and resetting of password

10-1. To change password (Functional Limit of Password)

The password is set to "0000" at shipment.

When you forget the password, install the software. The password will return to "0000". Regarding software installation, refer to the separate "System Handling Manual".

10-1-1. Screen

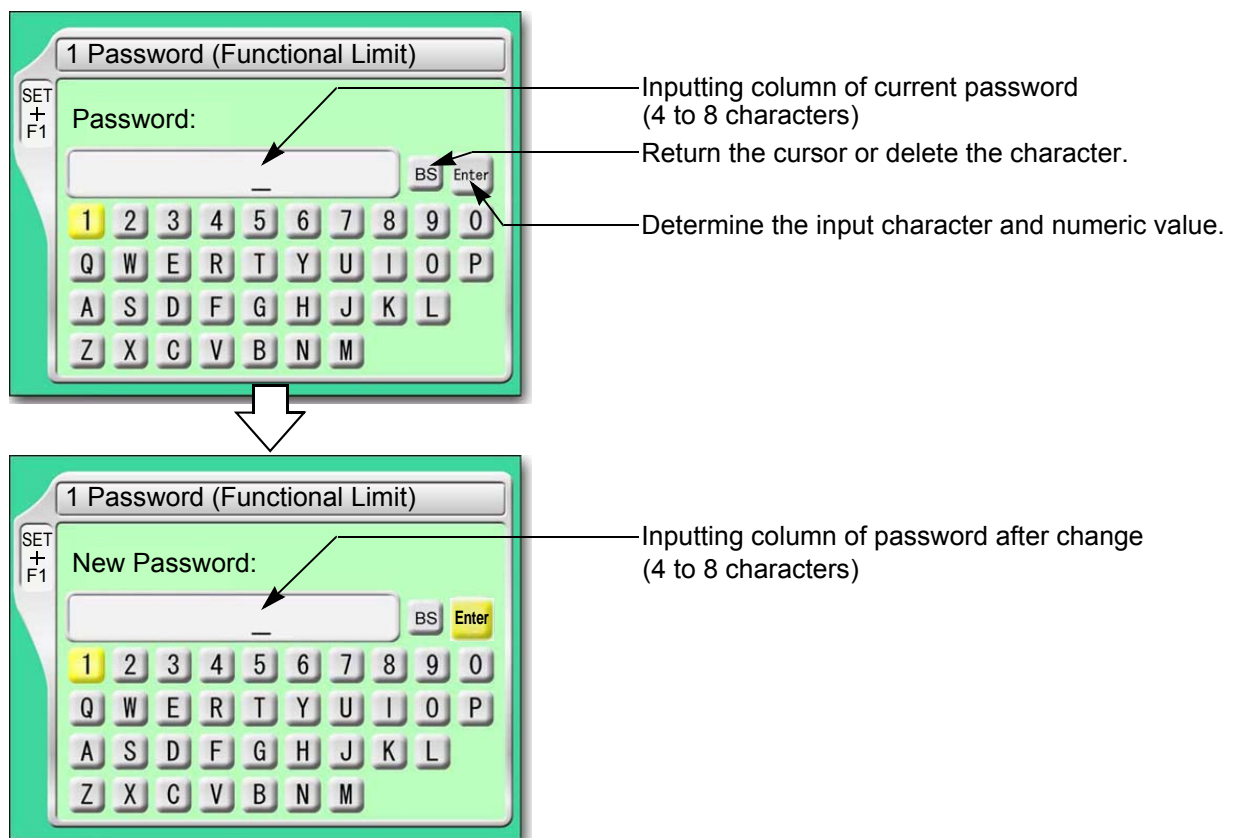

10-1-2. How to operate

The following is an example that the password is changed from "0000" to "ZY98".

- (1) Set to main screen.
- (2) Press F1 key while pressing SET key, and press SET key further.

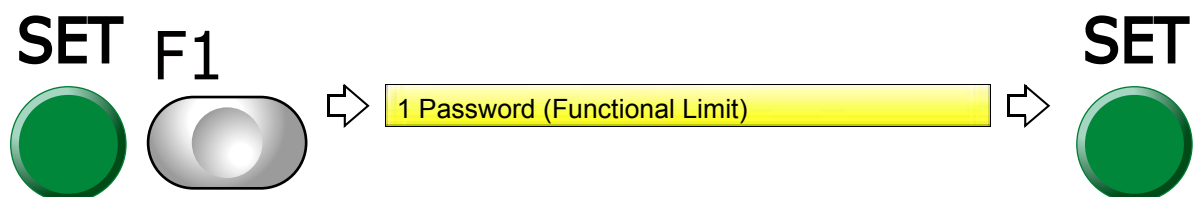

(3) To input the current password

(a) To select "0"



(b) To input the remaining password "0", "0", "0" in the same procedure.

(c) To decide



(4) To input password after change

(a) To select "Z"



(b) To select "Y"



(c) To select the remaining password "9", "8" in the same procedure

(d) To decide



- (5) To input password again after change
 - (a) To input password in the same procedure
 - (b) To decide



10-2. To cancel the password

The password is set for some function. Perform operation in the following procedure after canceling the password.

10-2-1. Screen

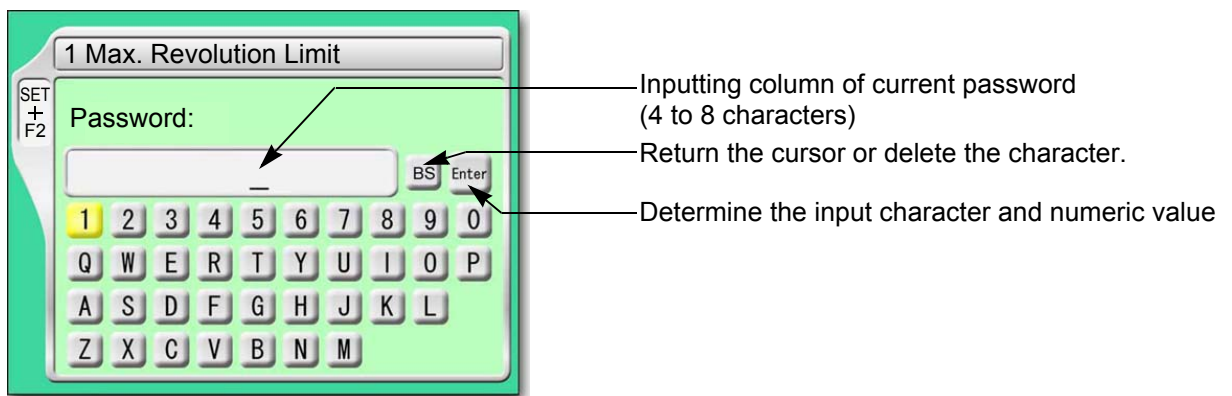

10-2-2. How to operate

The following is an example that the password "0000" is cancelled.

- (1) To select the password "0"

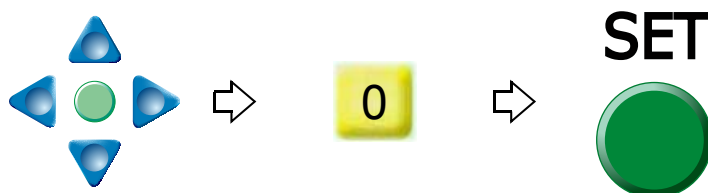

- (2) To select the remaining password "0", "0", "0" in the same procedure

- (3) To decide



11. Functions that must be remembered

11-1. To check the number of total stitches up to now (Total Stitch Counter)

11-1-1. Screen

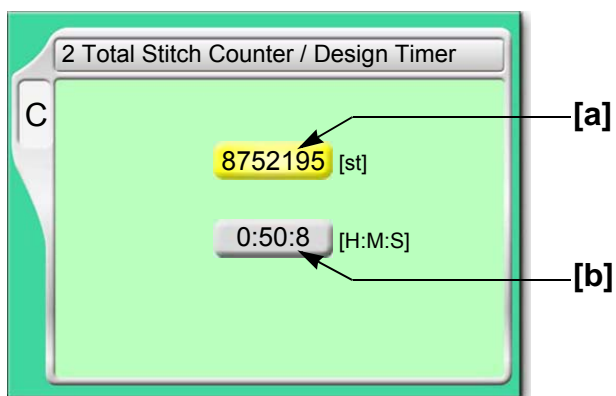

[a] The number of total stitches embroidered up to now. When resetting the value, select "0" and press SET key.

[b] Time from start after data set to the present (The screen shows an example of 50 minutes and 8 seconds.)

Counting continues even during sleep mode and turning OFF the power.

Embroidery time will be reset in the following conditions.

When the current embroidery is finished and the machine starts next

When data is set

11-1-2. How to operate

The following is an example that the total stitch counter is checked.

(1) To open screen

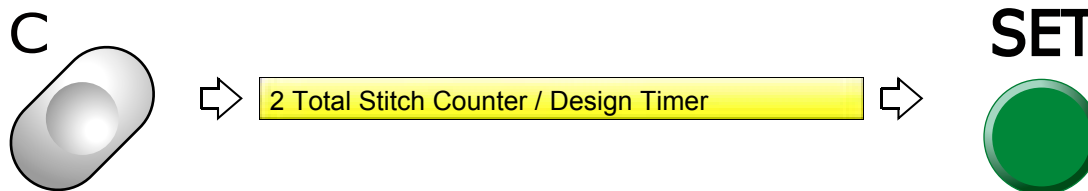

C screen will be displayed. Check the total stitch counter.

11-2. To color in every needle bar (Needle Bar Color)

Matching needle bar color with thread color used actually will display an image similar to the embroidered product.

11-2-1. Screen

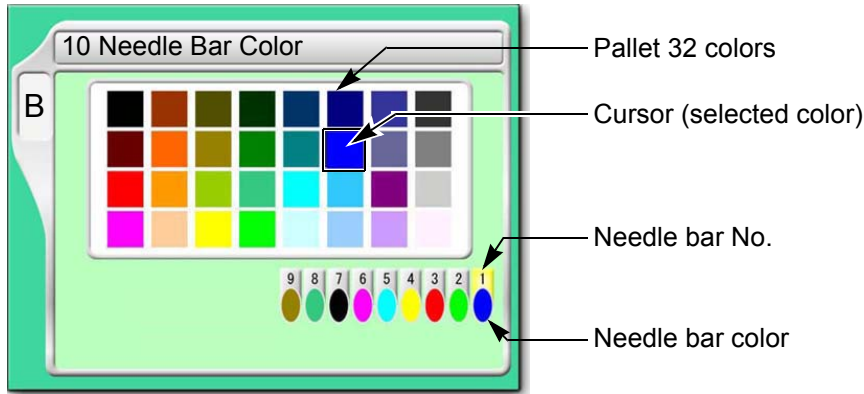

11-2-2. How to operate

The following is an example that the needle bar No.1 set to "red".

(1) To open screen



(2) To select the needle bar No.

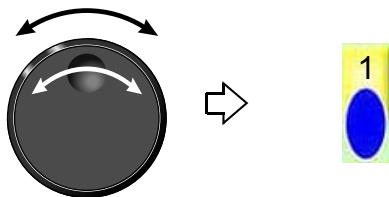

(3) To select color

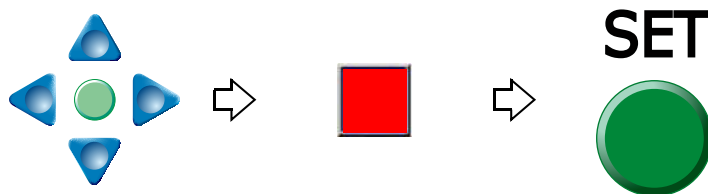

(4) To decide

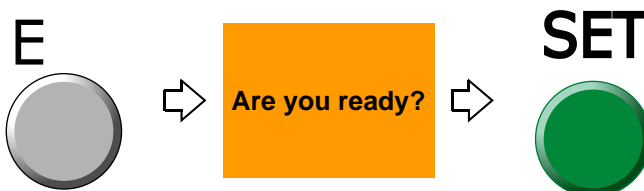

1
2
3
4
5
6
7
8
9
10
11

11-3. To display the setting color when making the design (Needle bar information)

11-3-1. Screen



YES:

Display the setting color when making the design.

When the information about the setting color is not included in the design data, the setting of "B-10 Needle bar color" will be effective.

NO:

Display the color being set in "B-10Needle Bar Color". (→p.137)

11-3-2. How to operate

The following is the example of displaying the setting color when making the design.

(1) Set to main screen.

(2) To press B key while pressing SET

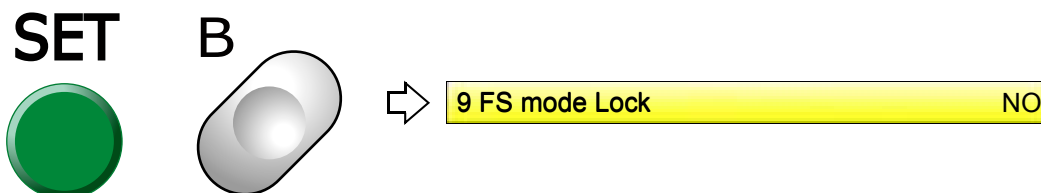

(3) To press B key

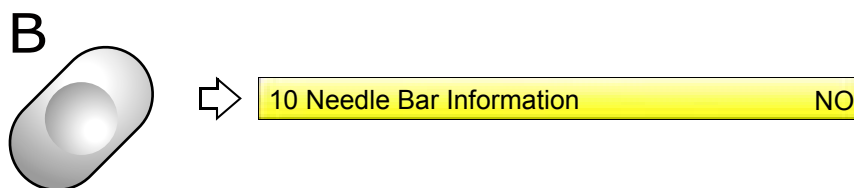

(4) To select Yes



11-4. To check version of current software (Software Version)

11-4-1. Screen

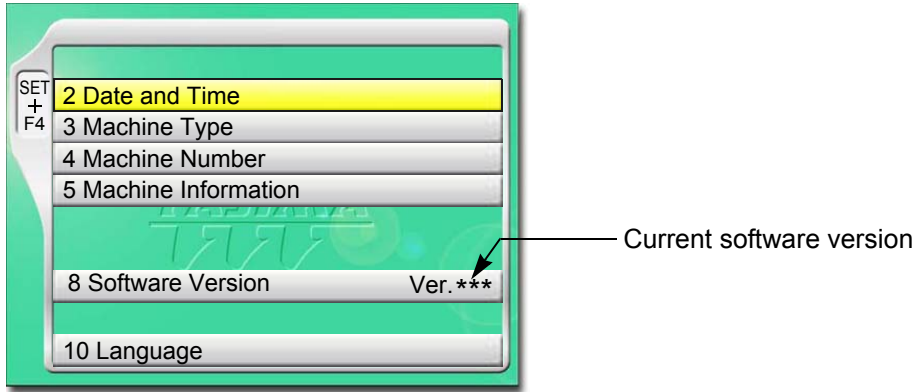

11-4-2. How to operate

The following is an example that the software version is checked.

- (1) Set to main screen.
- (2) To press F4 key while pressing SET

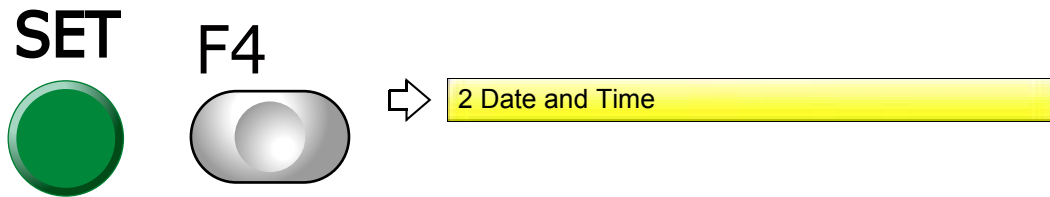

- (3) Since SET + F4 screen will be displayed, check the version of the software.

1
2
3
4
5
6
7
8
9
10
11

11-5. To switch display language (Language)

11-5-1. Screen

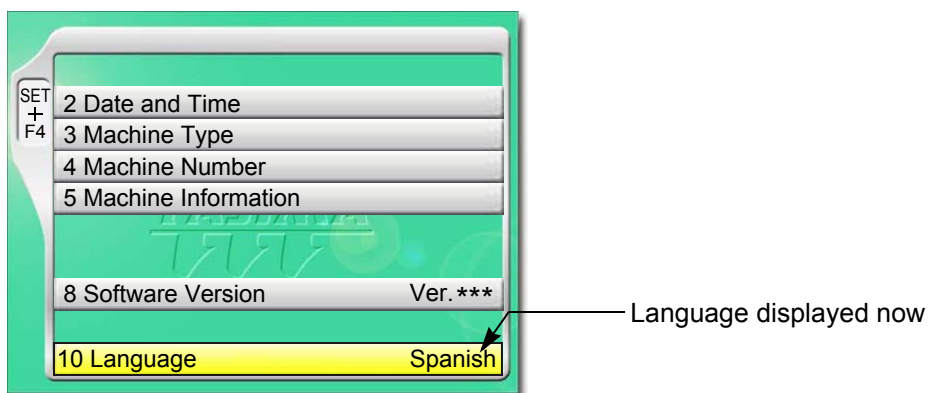

11-5-2. How to operate

The following is an example that the language is changed to "English".

- (1) Set to main screen.
- (2) To press F4 key while pressing SET

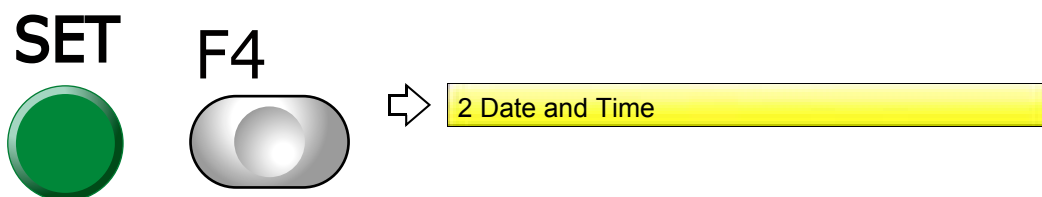

- (3) To press F4 key

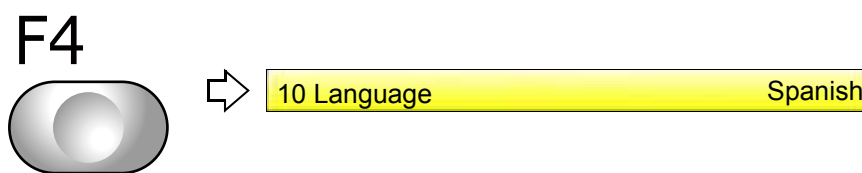

- (4) To select language

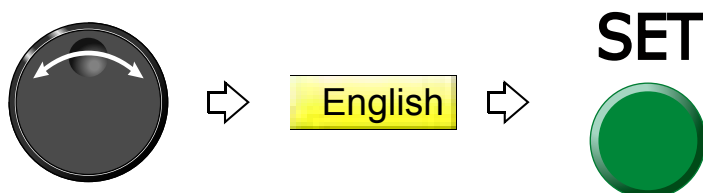

11-6. To release fixing of main shaft motor (weak brake)

It is the setting to release the fixing of the main shaft motor temporarily while the main shaft stops. This function is used for the maintenance of the machine mainly.

11-6-1. Screen

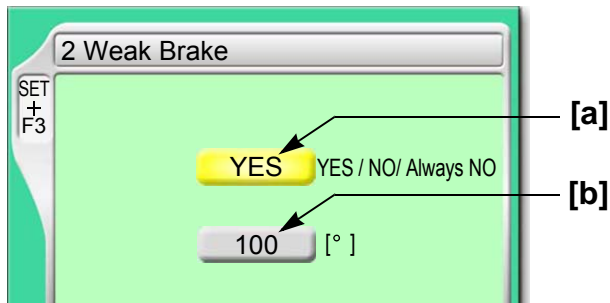

[a] Fixing of main shaft motor

YES: To fix the main shaft motor while the main shaft stops (usual setting)

NO: Not to fix the main shaft motor while the main shaft stops

Even if "NO" is selected, it will be switched to "YES" after starting the machine.

Always NO: Not to fix the main shaft motor always while the main shaft stops

"Always NO" will be displayed in TFMX-C, TWMX-C only.

[b] Current main shaft angle

When you desire to check the main shaft angle, set the value of above [a] to "NO" or "Always NO", and then turn the main shaft.

******* When left code is displayed, follow the procedure below.

1. Set the value of [a] to "NO".
2. Turn the main shaft slowly until the lamp in the figure below (indicated by an arrow) starts blinking. Method of turning the main shaft differs depending on the models. For detail, refer to the separate "Machine Setup Instructions".

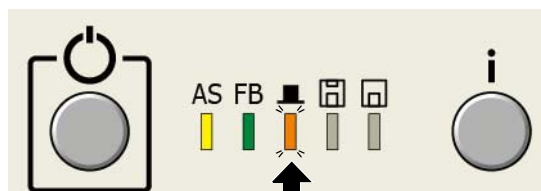

3. After the screen is switched (press E key) and the original screen is returned, "100" (Fixed position) will be displayed.

100

11-6-2. How to operate

The following is an example that the main shaft motor is set to "not to fix".

(1) Set to main screen.

(2) Press F3 key while pressing SET key, and press SET key further.

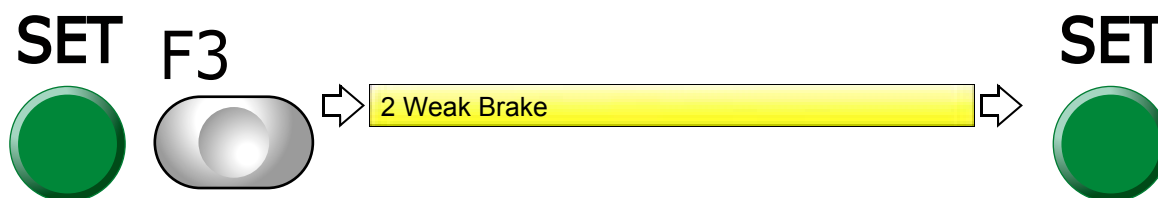

(3) To select not to fix

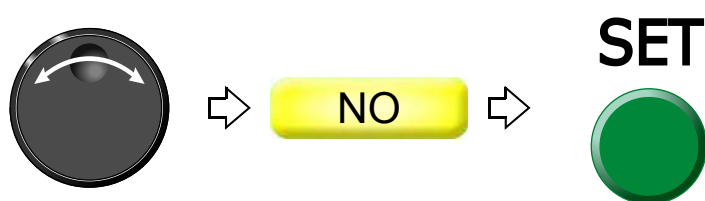

11-7. To display/Not to display the screen for reading Condition data
(Input confirmation of condition file)

When inputting data from USB memory, set to display or not to display the following message.

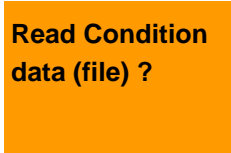

11-7-1. Screen



↑
YES: To display
NO: Not to display

11-7-2. How to operate

The following is an example when the screen of Read Condition data (file) is not displayed.

- (1) Set to main screen.
- (2) To press A key while pressing SET key

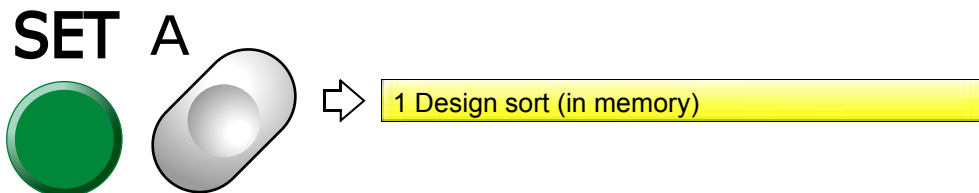

- (3) To press A key

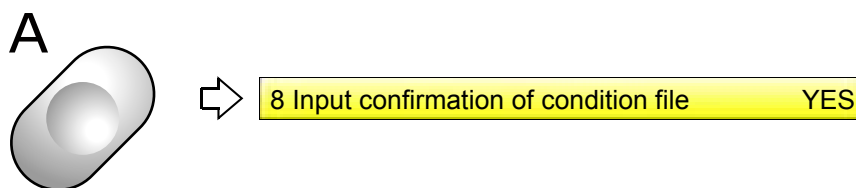

- (4) Not to display the screen of Read Condition File

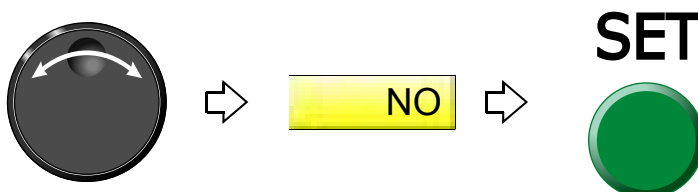

1
2
3
4
5
6
7
8
9
10
11

Chapter 6

Functions concerning frame movement

1. To return the frame (Frame Back) / to advance the frame (Frame Forward).....	146
2. Necessary works after replacing the frame	152
3. To return the frame to the original position	156
4. To return the frame to the design start position	162
5. To move the frame to the position registered.....	164
6. To register frame position	169

1. To return the frame (Frame Back) / to advance the frame (Frame Forward)

1-1. To switch Frame Back / Frame Forward

1-1-1. Screen

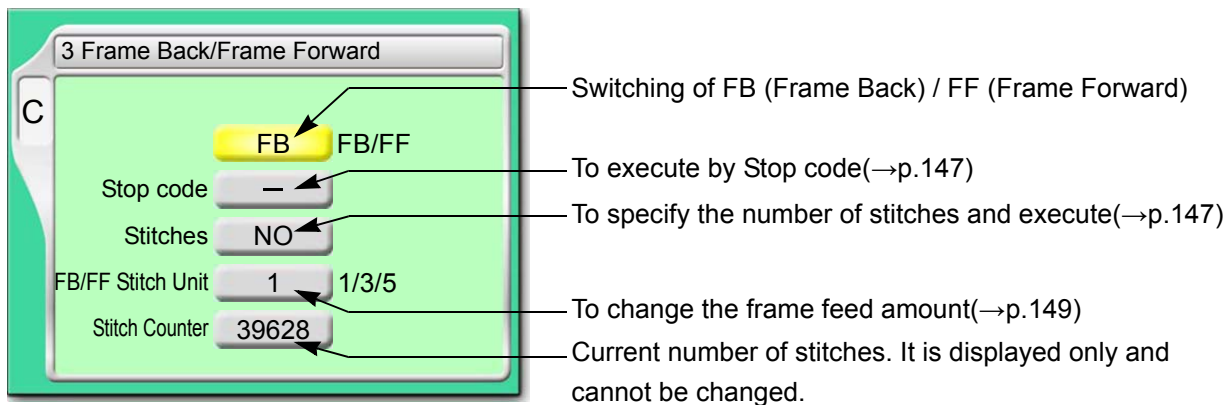

1-1-2. How to operate

The following is an example of setting frame forward.

(1) To open screen

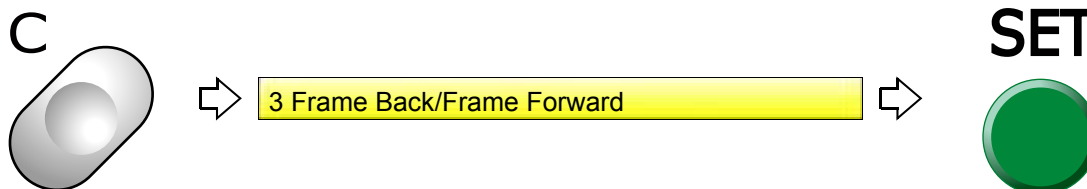

(2) To select FF (Frame Forward)

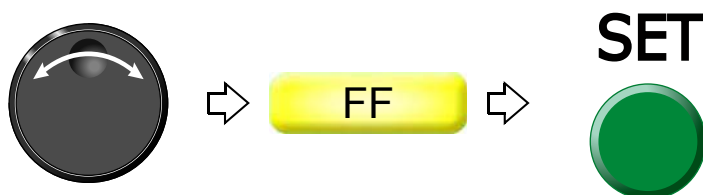

1-2. To execute by Stop code, to specify number of stitches to execute

1-2-1. Explanation on the screen

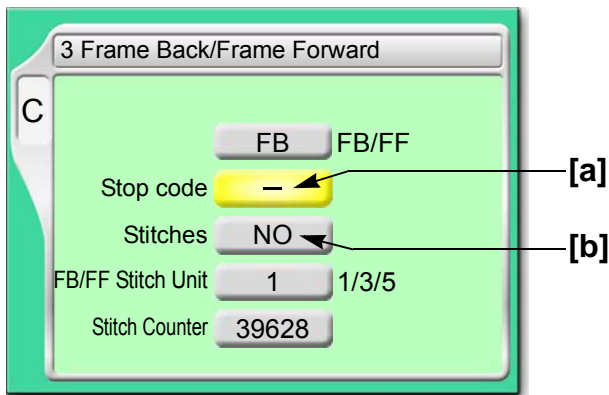

[a] To perform Frame Back or Frame Forward in Stop code

– : Not to execute

O : To execute

[b] To perform frame back or frame forward by specifying the number of stitches

NO: Not to perform

1 to end stitch:

To perform (to perform Frame Back or Frame Forward for the number of stitches)

1-2-2. How to operate



The following is an example of executing frame forward by Stop code.

(1) To open screen

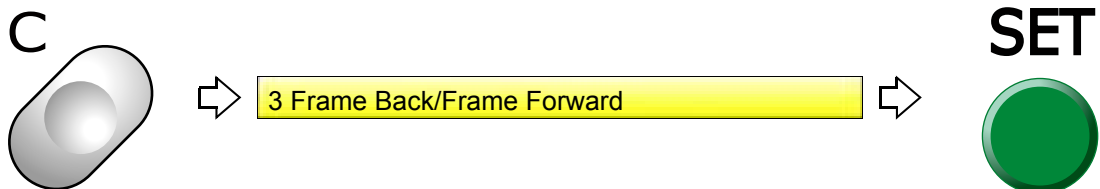

(2) To select FF (Frame Forward)

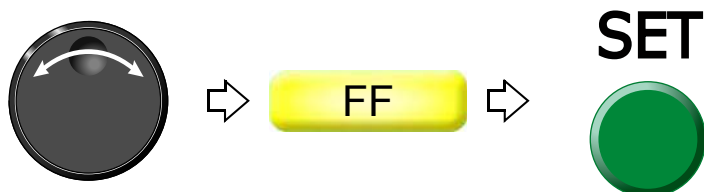

(3) To move the cursor to "Stop code"



(4) To perform Frame Forward in Stop code

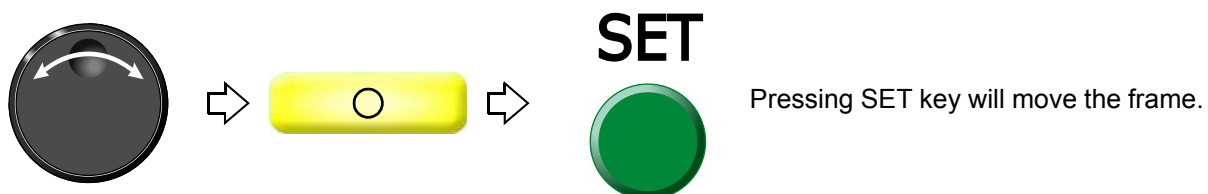

1-2-3. How to operate

 CAUTION
<p> When performing this operation, do not put your hands etc. on the machine table. Moving frame could injure you.</p>

The following is an example of specifying the number of stitches and executing frame forward.

(1) To open screen

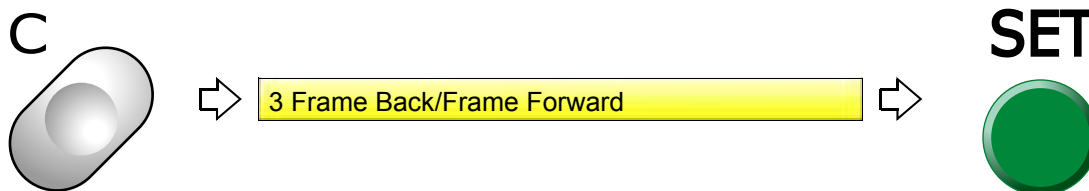

(2) To select FF (Frame Forward)



(3) To move the cursor to "Specification by the number of stitches"



(4) To input the number of stitches and execute

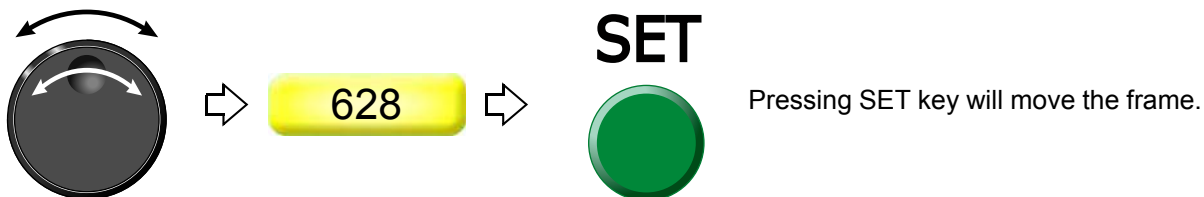

1-3. To change a frame feed amount of frame back / frame forward

This function sets a frame feed amount when 11-stitches or more is successive due to the operation of frame back/frame forward by the stop switch or the bar switch.

1-3-1. Explanation on the screen

1-3-2. How to operate

The following is an example of setting the frame feed amount to "5".

(1) To open screen

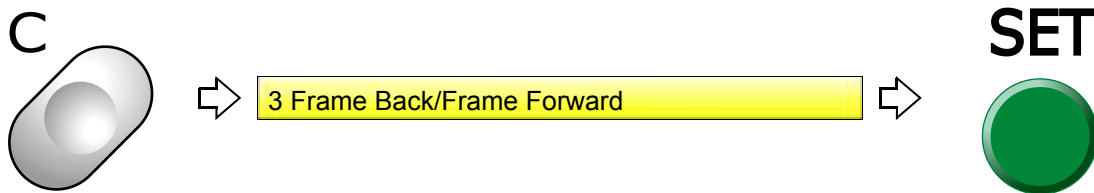

(2) To move the cursor to "FB/FF Stitch unit"



(3) To select frame feed amount



1-4. To set All Head Sewing Start Point (Frame Back All Head Sew)

This function applies to 2 or more head machines. This setting sets "All Head Sewing Start Point After Frame Back" and "Whether the machine stops at the position just before All Head Sewing Start Point or not".

1-4-1. Explanation on the screen

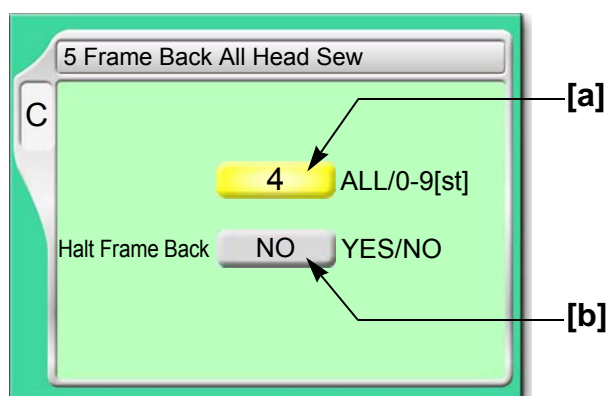

[a] Frame Back All head Sew

ALL: All heads sew the whole section of frame back.

When ALL is selected, "Halt Frame Back" is fixed to NO.

0 - 9: All Head Sewing Start Point

The value indicates the number of stitches from a frame back start point.

[b] The machine stops at the position just before All Head Sewing Start Point.

YES: To stop

NO: Not to stop

1-4-2. How to operate

The following is an example of setting All Head Sewing Start Point to "3" and setting to "Stop" at the position just before All Head Sewing Start Point.

(1) To open screen



(2) To select All Head Sewing Start Point

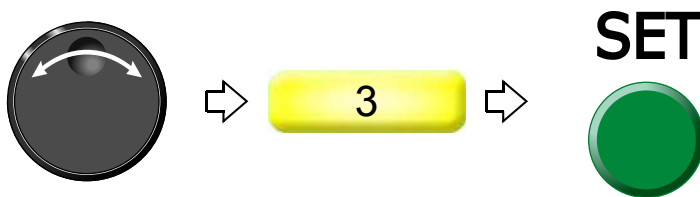

(3) The machine stops at the position just before All Head Sewing Start Point.



1
2
3
4
5
6
7
8
9
10
11

2. Necessary works after replacing the frame

2-1. To change frame type

2-1-1. Screen

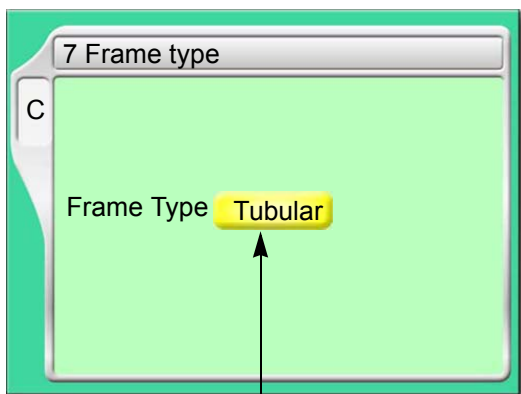

Current frame type

Machine type	Frame Type
TFMX-IIC TYPE-2	Border, Tubular, Cap 2 (including the pocket frame), Frame holder, Cylinder
TFMX-C	Border, Tubular, Cap (including the pocket frame), Auto clamp B, Auto clamp T, Cylinder
TWMX-C	Border (W), Tubular (W), Cap (including the pocket frame), Auto clamp B, Auto clamp T, X-ext (W)
TFMX (L)	Border

When selecting "Tubular (W)", "Border (W)" in TWMX-C, the maximum speed will be limited at 1000 rpm. When selecting "X-ext (W)", the revolution limit will be the following value.

High speed: 700 rpm

Low speed: 300 rpm

Moreover, when selecting "X-ext (W)", Auto jump will be set forcibly, and the setting range will be 2.0 to 4.0 mm. (Initial value is 4.0 mm.)

2-1-2. How to operate

The following is an example of setting the frame type to "Cap".

(1) To open screen

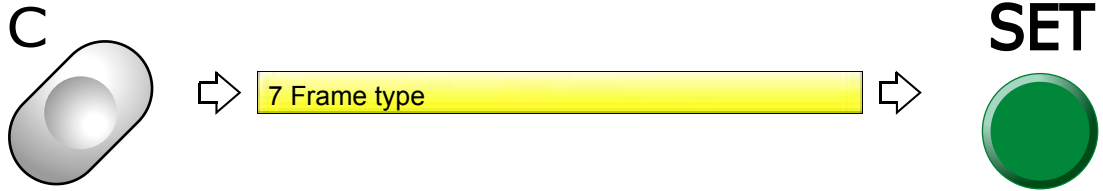

(2) To select the frame

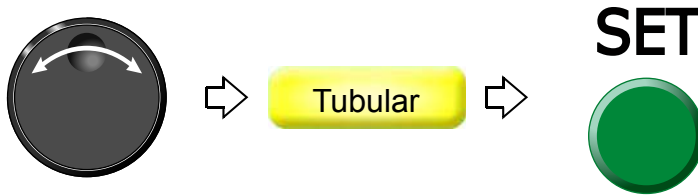

(3) To execute Frame Origin Memory (The below message will not be displayed for L-spec. machine.)

The following message will be displayed only when "Frame origin memory with the power ON" is set to "YES".(→p.160)

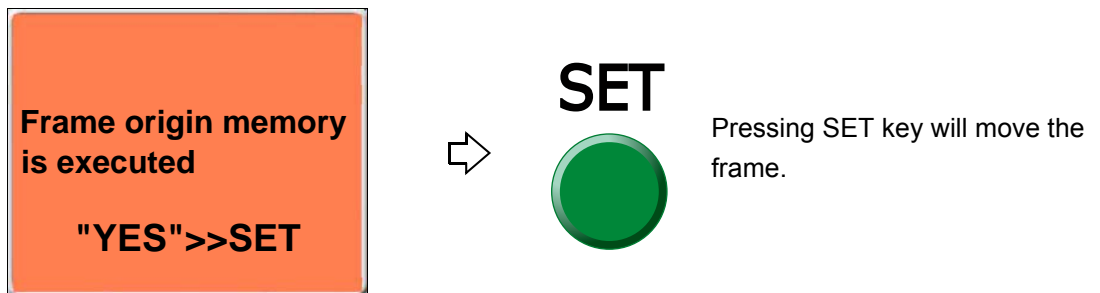

1
2
3
4
5
6
7
8
9
10
11

To set the frame type to "A. clamp T" (Auto Clamp T), follow the procedure below.

CAUTION

! To execute "Frame Origin Memory", follow the procedure below. The frame could hit the machine depending on the frame position and it might cause the damage of the parts.

Frame origin memory is executed.

"YES">>SET

⇒

SET



Pressing SET key will move the frame.

⇒

○ STOP

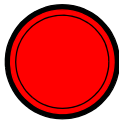

Press the stop switch immediately after moving the frame.

⇒

Code No. 5C1 will appear.

⇒

E

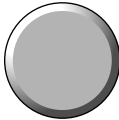

Press E key.

- ⇒ Move the frame to the upper right position from the center of the embroidery space by manual frame travel.

⇒ Perform operation of "Frame Origin Memory". (SET+F2)

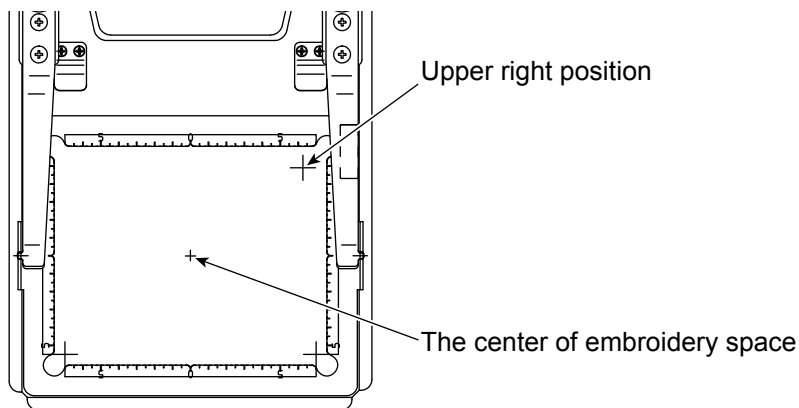

2-2. To rotate the design by 180 degrees when a cap frame is equipped
(Design rotation by 180 degrees on Cap Frame)

This function can be set only when "Frame type" is set to "Cap".(→p.152)

It is unnecessary to rotate the design to set data conversion.

2-2-1. Explanation on the screen

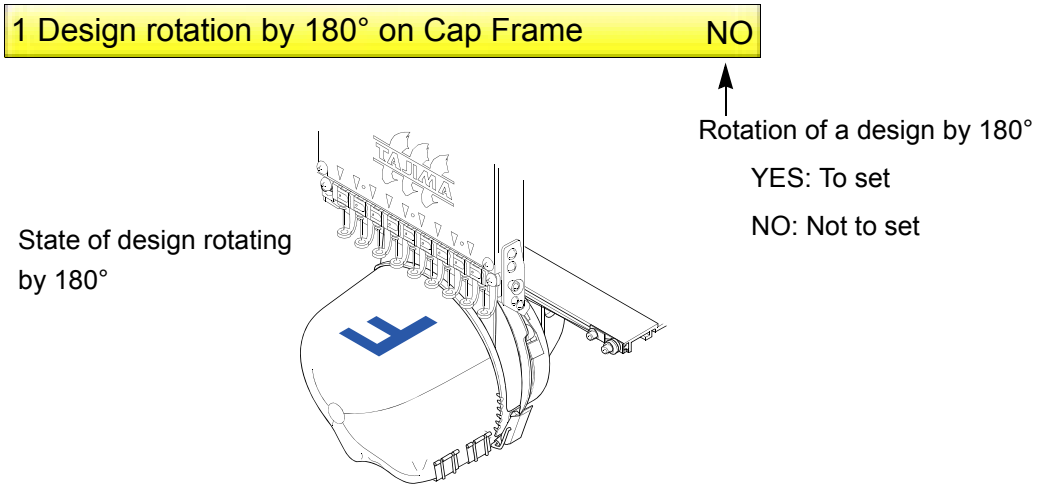

2-2-2. How to operate

The following is an example of setting of design rotation by 180 degree to "To perform".

- (1) Set to main screen.
- (2) To press B key while pressing SET

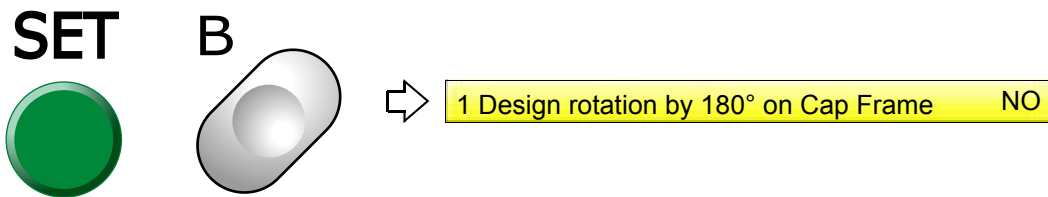

- (3) To make the design rotation by 180 degrees on Cap Frame effective



3. To return the frame to the original position

3-1. To return the moved frame to the previous position (Manual Offset)

This function is effective only when the frame is moved manually after stopping the machine in the middle of embroidery.

3-1-1. Screen



↑
To return the frame to the original position

— : Not to execute

○ : To execute

3-1-2. How to operate



The following is an example of executing manual offset.

(1) To open screen

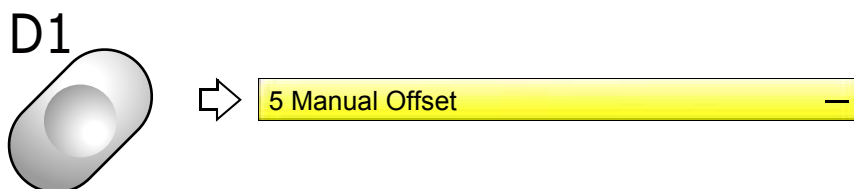

(2) To perform manual offset

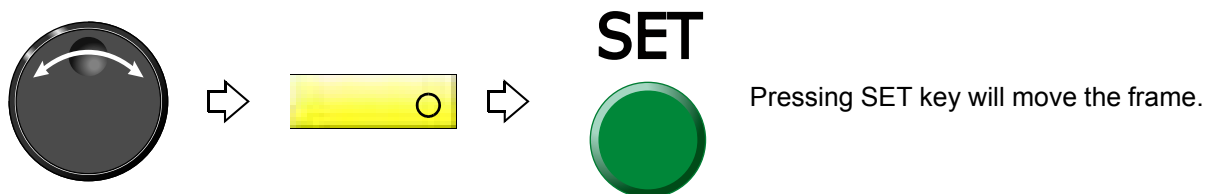

3-2. To return moved frame to original position and start operation (Return the frame after manual frame travel)

This function is effective only when the frame is moved manually after stopping the machine in the middle of embroidery.

3-2-1. Screen



Setting to return or not to return the frame by operating the bar switch or the start switch

YES:

The frame will return to the original position and the machine will start operation.

NO:

The frame will not return. The operation will start from the position after frame travel.

3-2-2. How to operate

The following is an example of returning the frame to the original position and starting the operation.

- (1) Set to main screen.
- (2) Press F2 key while pressing SET key.

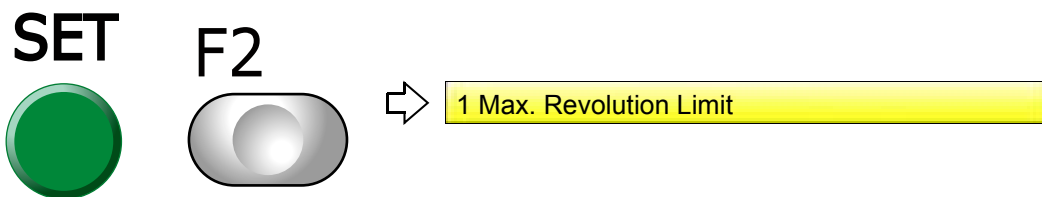

- (3) Press F2 key.

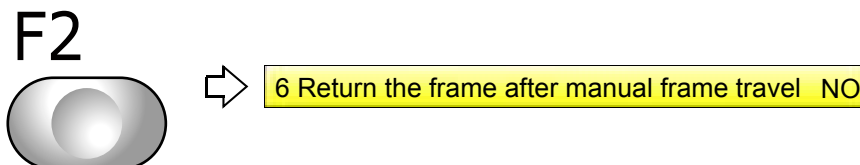

- (4) To return the frame by operating the bar switch or the start switch, and start the operation.



3-3. To prevent displacement of design when the power is shut off during operation (Power resume)

This function works on condition that the frame origin is memorized correctly. If it is wrong, the frame will not return to the correct position.

3-3-1. Screen

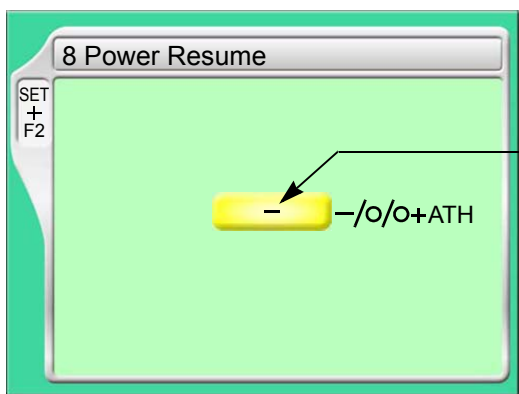

To return the frame to several stitches before the position where power was shut off

- : Not to execute

o : To execute

o+ATH : To execute after thread trimming

3-3-2. How to operate

CAUTION

When performing this operation, do not put your hands etc. near the needle or on the machine table. Moving needle bar or frame could injure you.

The following is an example of executing Power resume.

(1) Set to main screen.

(2) Press F2 key while pressing SET key.

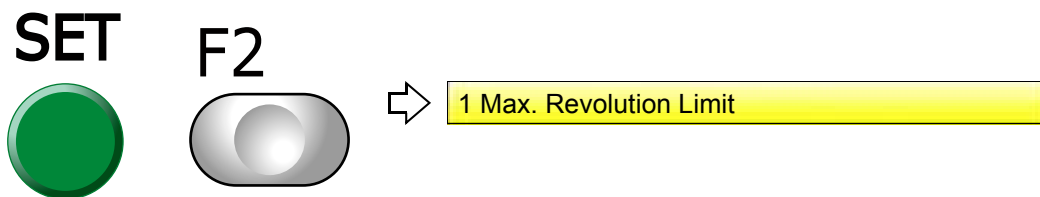

(3) Press F2 key.

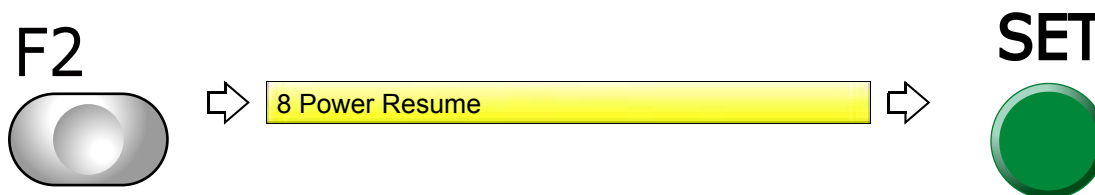

(4) To execute after thread trimming



3-4. To memorize frame origin (Frame origin memory)

Frame origin is an anchoring point (X:0.0, Y:0.0) to calculate the current frame position. Position of frame origin differs depending on model.

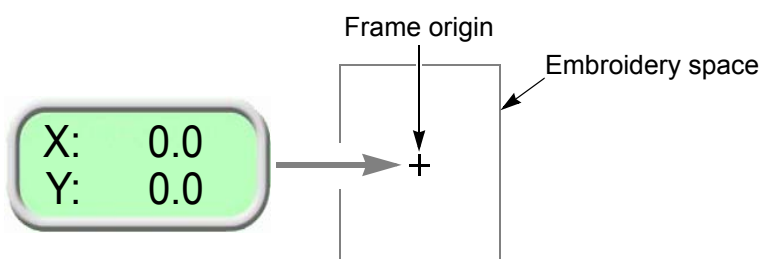

Execute this function in case of the following condition.

- (1) There is a possibility that the frame was moved by hand in the state of power OFF or during sleep mode in such a case as changing frame.
- (2) After installation of software
- (3) When frame driver is changed
- (4) When frame type is changed

When a frame origin is wrong, the following troubles will occur.

- Frame coordinates are not displayed correctly.
- The frame does not return to the interrupted position even after performing Power resume.
- Position of frame limit gets out of alignment.

3-4-1. Explanation on the screen

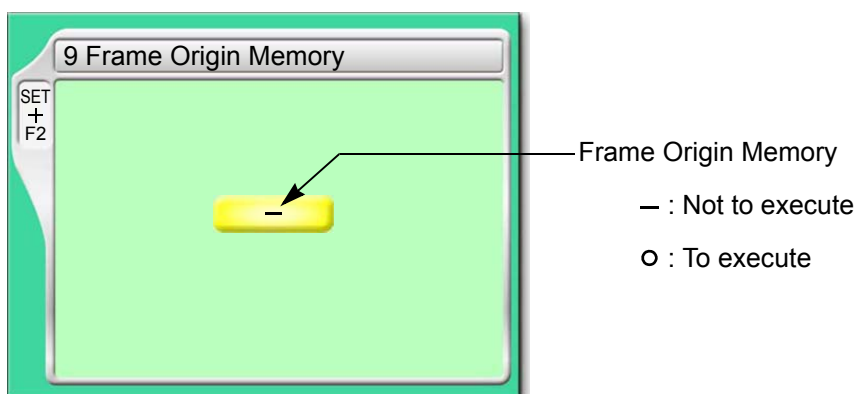

3-4-2. How to operate

⚠ CAUTION

⊘ When performing this operation, do not put your hands etc. on the machine table. Moving frame could injure you.

The following is an example of executing frame origin memory.

- (1) Set to main screen.
- (2) Press F2 key while pressing SET key.

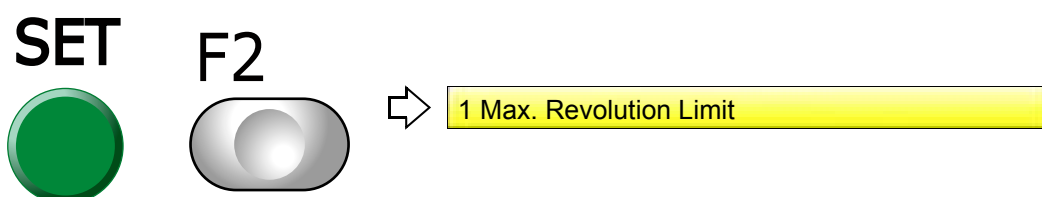

- (3) Press F2 key.

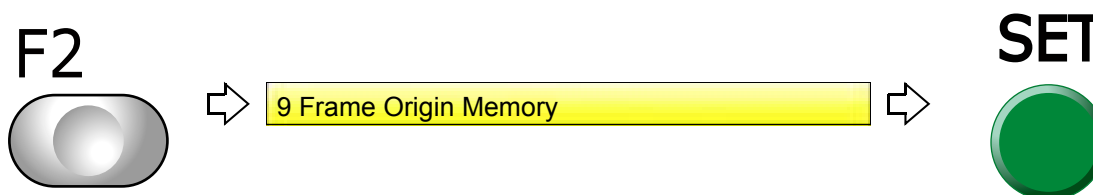

- (4) Execute Frame Origin Memory.

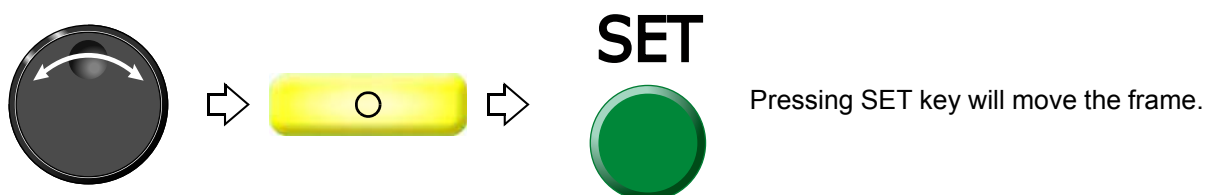

3-5. To perform Frame origin memory when the power is turned ON
(Frame origin memory with the power-ON)

This function does not correspond to L-spec. machine.

This is the setting to display the message, and perform Frame origin memory when the power is turned ON.

When the embroidery is on the way or the main shaft is out of the fixed position, the message will not be displayed.

**Frame origin memory
is executed.**

"YES">>SET

3-5-1. Screen

7 Frame origin memory with the power-ON NO

↑
Display of the message to urge frame origin memory

YES: To display

NO: Not to display

Even if the power is turned ON again in the middle of the embroidery at the setting of "YES", any message will not be displayed.

3-5-2. How to operate

The following is an example of displaying the message to suggest frame origin memory.

(1) Set to main screen.

(2) To press F1 key while pressing SET

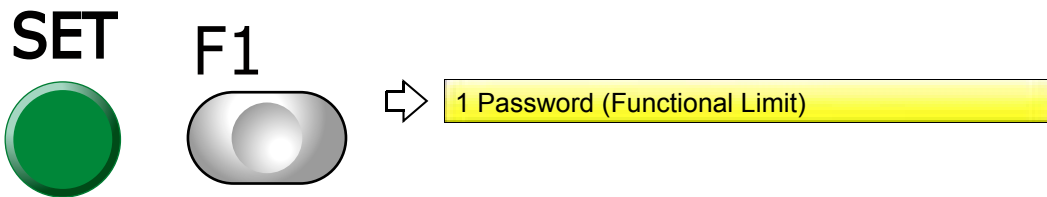

(3) To press F1 key

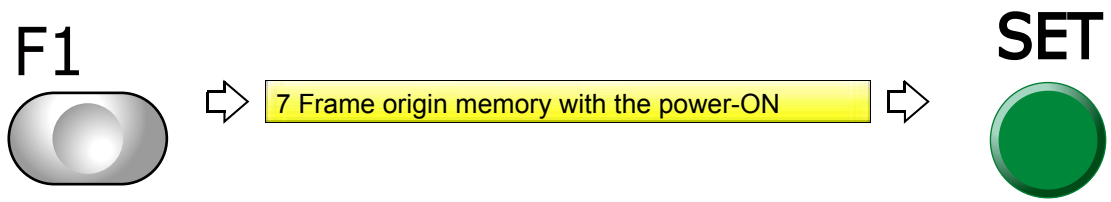

(4) To display the message



1
2
3
4
5
6
7
8
9
10
11

4. To return the frame to the design start position

4-1. To return the frame to the design start position manually (Return to the design start position)

This function makes the frame return to the design start position in the middle of embroidery when you stopped the machine.

4-1-1. Screen



↑
To return the frame to the design start position

— : Not to execute

○ : To execute

4-1-2. How to operate



The following is an example of executing design start position return.

(1) To open screen

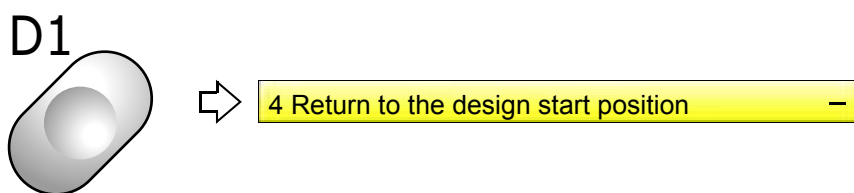

(2) To execute design start position return

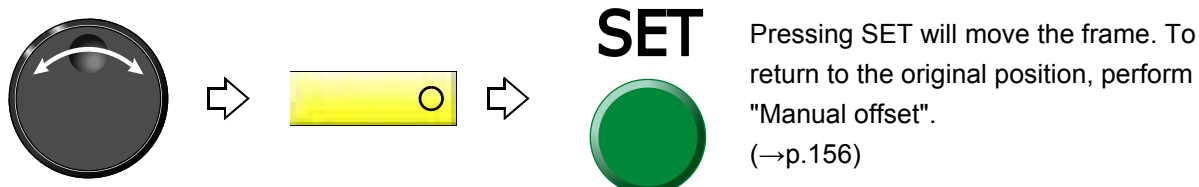

4-2. To return the frame to the design start position automatically (Auto Origin Return)

This is the setting to return the frame to the design start position automatically after embroidery is finished. When Automatic offset is set, the frame will return to an offset start position.(→p.164)

4-2-1. Screen



4-2-2. How to operate



The following is an example of setting Automatic origin return.

(1) To open screen

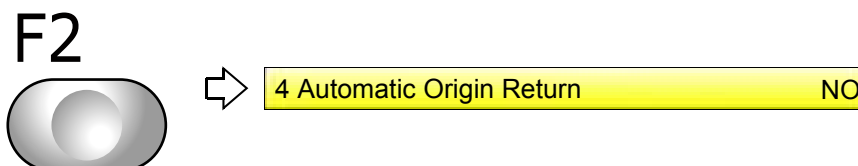

(2) To make auto origin return effective



5. To move the frame to the position registered

5-1. To move the frame automatically at the start and the end of embroidery (Automatic Offset)

This is the setting to move the frame automatically so that replacement of the frame and the fabric to be stretched can be performed easily. Perform this setting after data set. Setting contents here will be added in a design. So, when you embroider this design next time, setting again will be unnecessary.

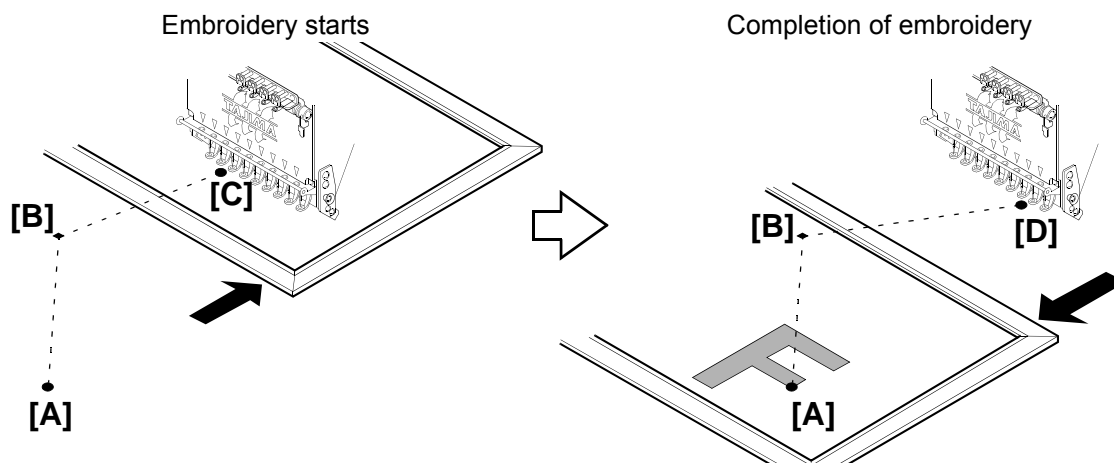

- (1) At the start of embroidery, by operating the bar switch or the start switch, the frame will pass from the offset start position [A] through the offset middle position [B] and move to the design start position [C].
- (2) When embroidery is finished, the frame will pass from the design end point [D] to the offset start position [A] through the offset middle position [B].

5-1-1. Explanation on the screen

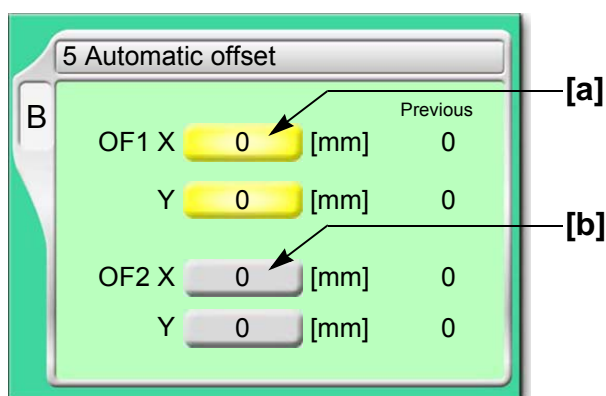

[a] Offset middle position [B in the figure above]

The position where the frame will pass. This position is arbitrarily set. Set it when embroidered material hits the machine during the frame travel.

[b] Offset start position [A in the figure above]

The position where the frame has come to the front. Changing the frame and the fabric to be stretched will be performed here.

5-1-2. How to operate

! CAUTION

⊘ When performing this operation, do not put your hands etc. on the machine table. Moving frame could injure you.

⊘ At the start and the end of embroidery, do not put your hands etc. on the table. Moving frame could injure you.

The following is an example of executing Automatic offset.

- (1)** To decide an embroidery design (to perform data set)
- (2)** To move the frame to the design start position [C]
- (3)** To open screen



- (4)** To decide OF1 (Offset Middle Position [B])

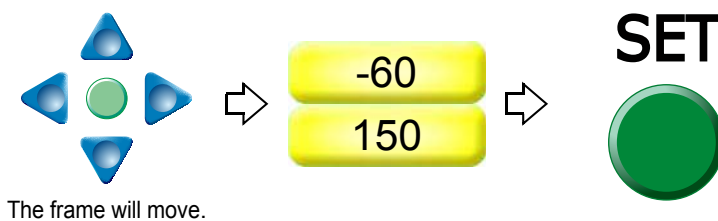

- (5)** To decide OF2 (Offset Start position [A])

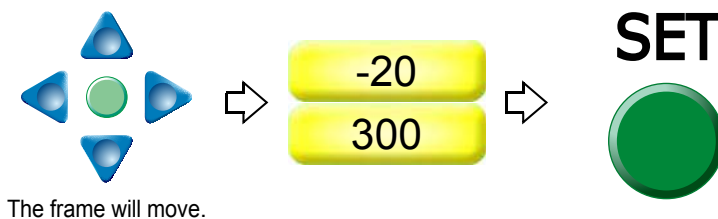

To cancel setting for Automatic offset, set values of OF1 and OP2 described above to "0".

1
2
3
4
5
6
7
8
9
10
11

5-2. To move the frame automatically at the start, in the middle and the end of embroidery

This function is the setting to move the frame automatically so that replacement of the frame, works for applique and change of fabric to be stretched can be performed easily.

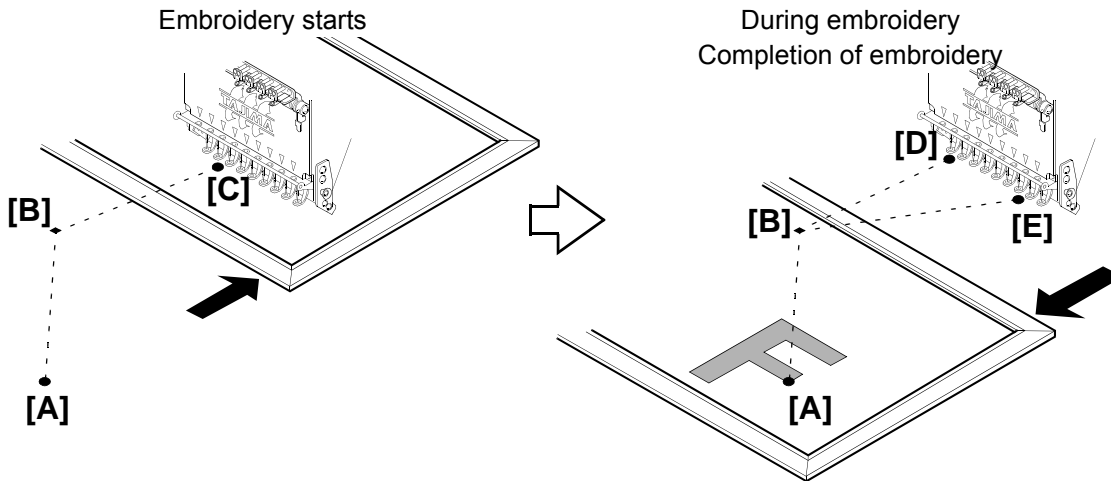

- (1) At the start of embroidery, by operating the bar switch or the start switch, the frame will pass from the offset start position [A] through the offset middle position [B] and move to the design start position [C].
- (2) During embroidery, the frame will return from the color change point [D] to the offset start position [A] through the offset middle position [B]. After performing works for applique here, the frame will move to the color change point [D] through the offset middle position [B], then start embroidery again by switch operation.
- (3) When embroidery is finished, the frame will pass from the design end point [E] through the offset middle position [B], then move to the offset start position [A].

5-2-1. Explanation on the screen



Offset mark

After step 2 is finished, the frame will return to the offset start position [A] automatically. To move the frame, the setting of "Automatic offset" is necessary. (→p.164)

If "Automatic Offset" is not set, the frame will move to the design start position [C].

5-2-2. How to operate

The following is an example of inserting the offset mark between step 2 and step 3.

(1) To open screen

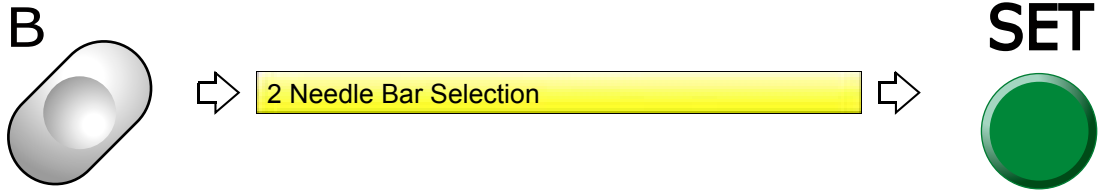

(2) To select step to insert offset mark

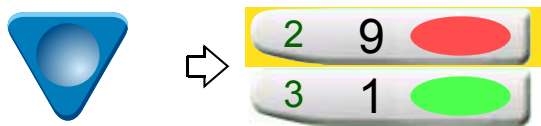

(3) To insert offset mark

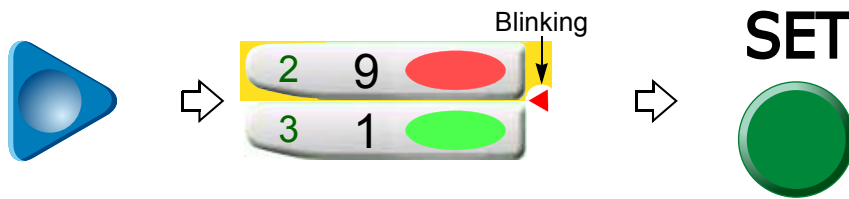

To delete offset mark

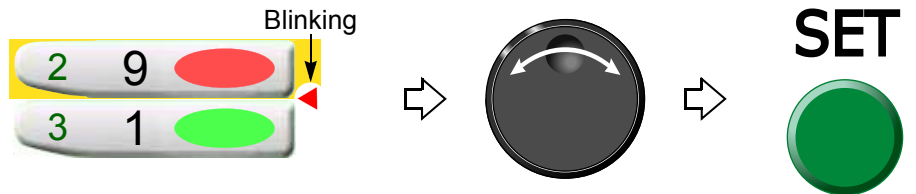

1
2
3
4
5
6
7
8
9
10
11

5-3. To return the frame to the offset start position manually (Return to the offset origin)

This function makes the frame return to the offset start position in the middle of embroidery when you stopped the machine. It is possible to operate only when Automatic offset is set. The offset middle position is not passed.

5-3-1. Screen



↑
To return the frame to offset start position
— : Not to execute
○ : To execute

5-3-2. How to operate



The following is an example of executing offset return.

(1) To open screen

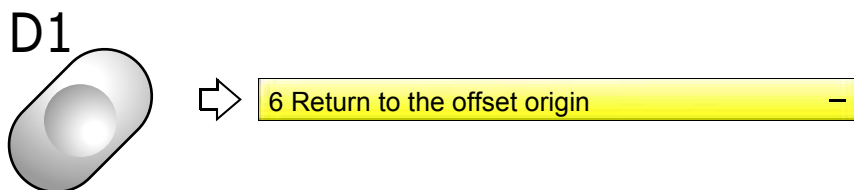

(2) To execute offset return

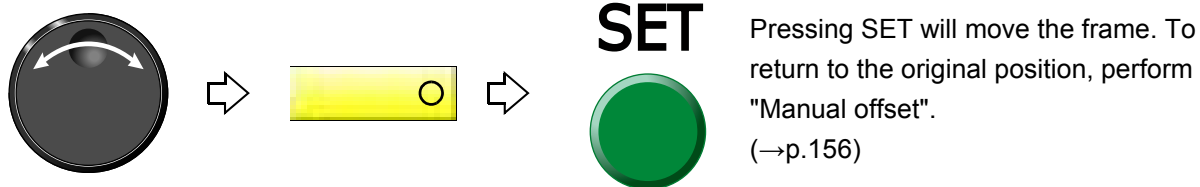

6. To register frame position

6-1. To register the frame position to make threading easily (table offset position)

This function targets the model equipped with table offset switch. Pressing the table-offset switch will set position (the table-offset position) to where the frame moves.

6-1-1. Screen

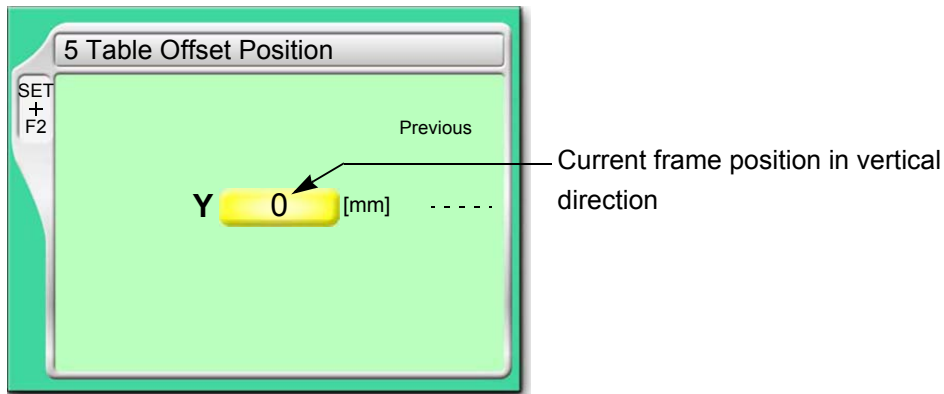

6-1-2. How to operate

The following is an example of setting the table offset position.

- (1) Set to main screen.
- (2) Press F2 key while pressing SET key.

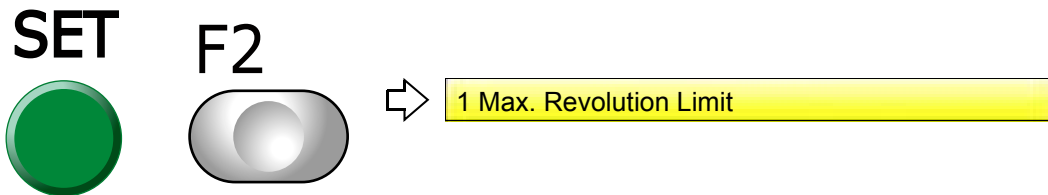

- (3) Press F2 key.

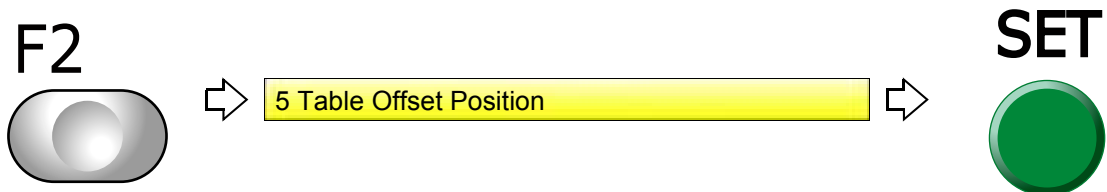

- (4) To set table offset position



Chapter 7

Function concerning storing and deleting of design

- 1. Design stored in the machine memory172
- 2. Design saved in USB memory184

1. Design stored in the machine memory

1-1. To delete a design (Memory Delete)

1-1-1. Explanation on the screen

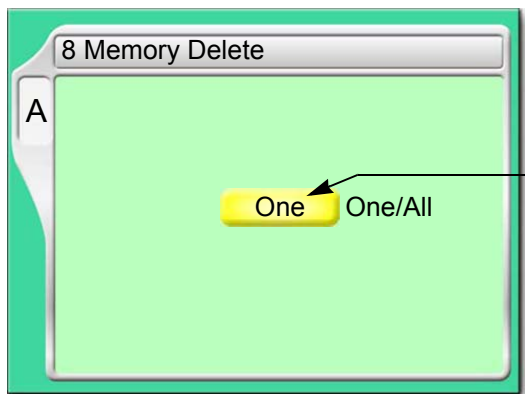

How to delete a design

One: The selected design is deleted one by one.

All: All designs are deleted at once.

1-1-2. How to operate

The following is an example of deleting a selected design.

(1) To open screen

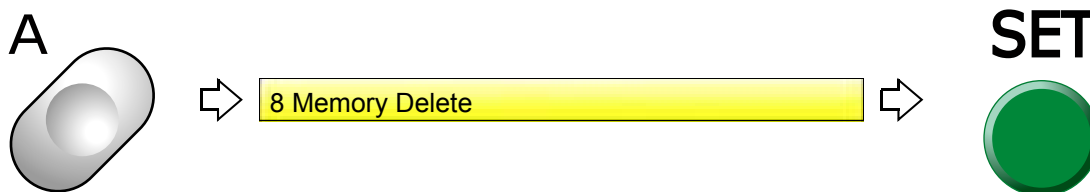

(2) Select a deleting method.

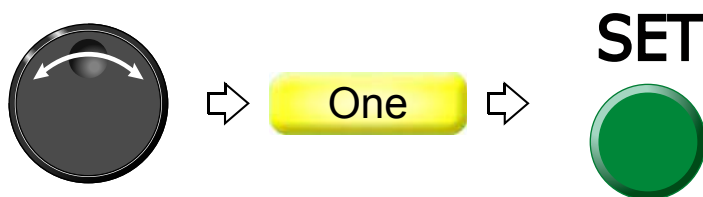

(3) To select and decide a design

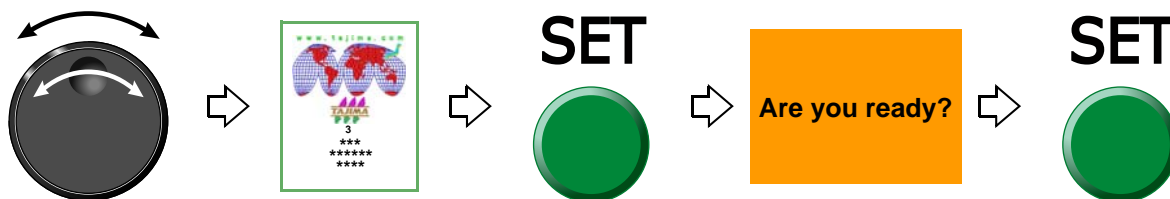

1-2. To move a design (Movement of design)

1-2-1. Screen

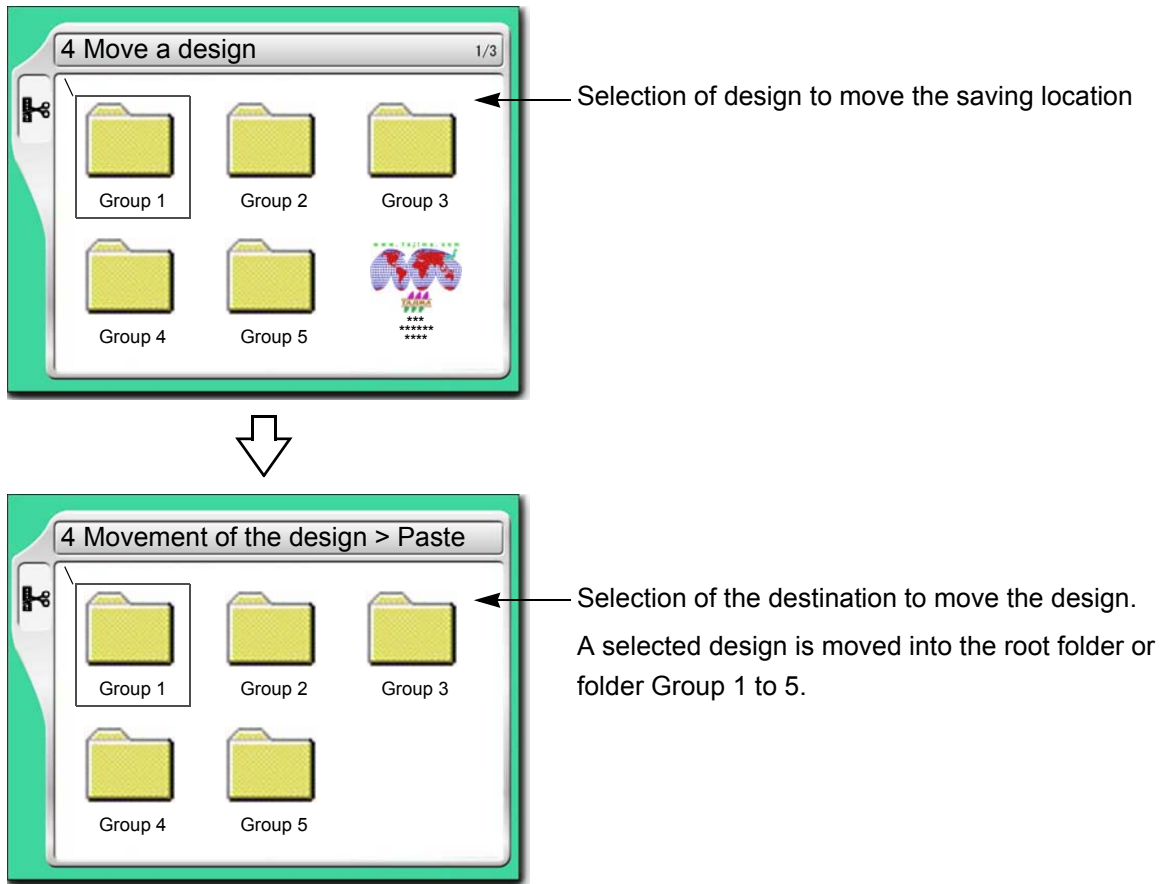

1-2-2. How to operate

The following is an example of moving a design to the folder (Group 3).

(1) To open screen

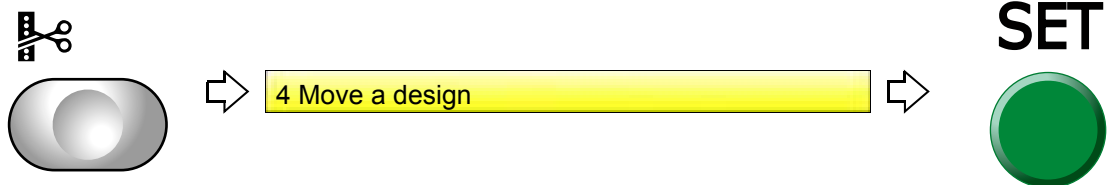

(2) To select a design

The operation differs depending on the storing place of the design.

(a) Design in folder



(b) Design on screen

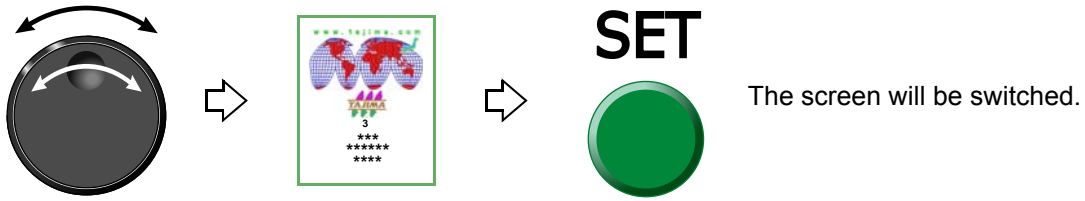

(3) To select destination to move and decide

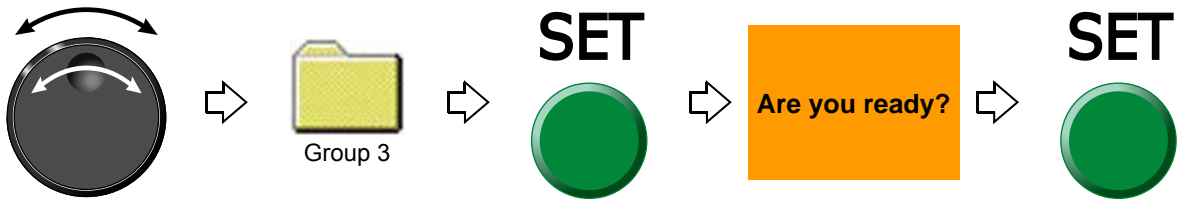

1-3. To copy a design (Copy a design)

1-3-1. Screen

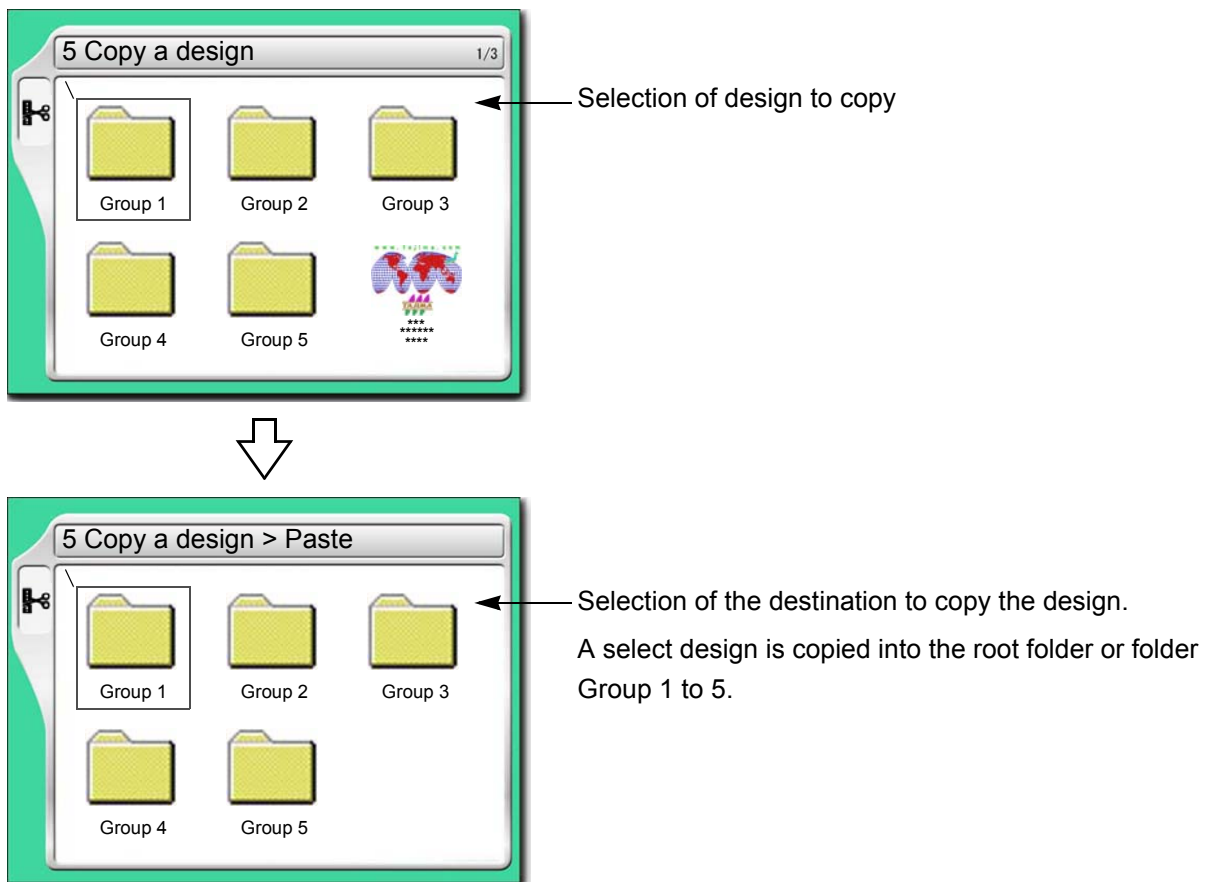

1-3-2. How to operate

The following is an example of copying a design and storing it in the folder (Group 3).

(1) To open screen

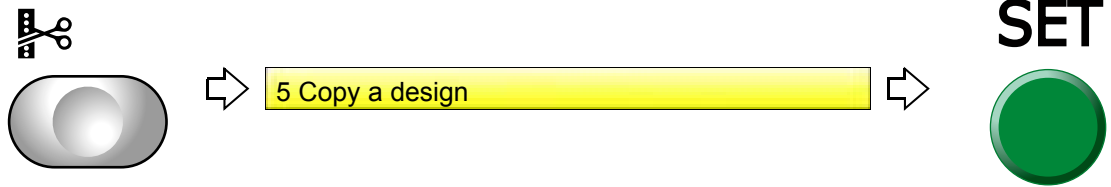

(2) To select a design

The operation differs depending on the storing place of the design.

(a) Design in folder



(b) Design on screen

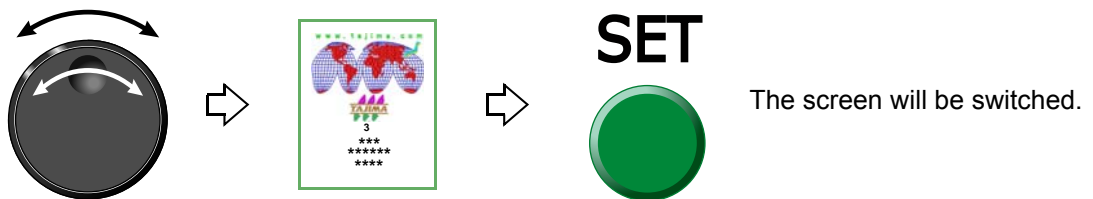

(3) Select a destination to copy, and decide.

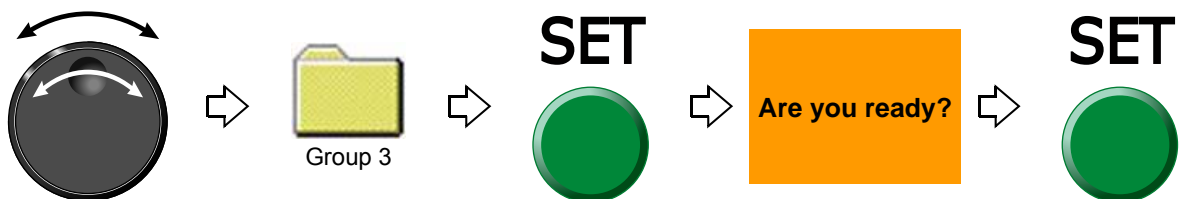

1
2
3
4
5
6
7
8
9
10
11

1-4. To change the file name of the design (Changing design name)

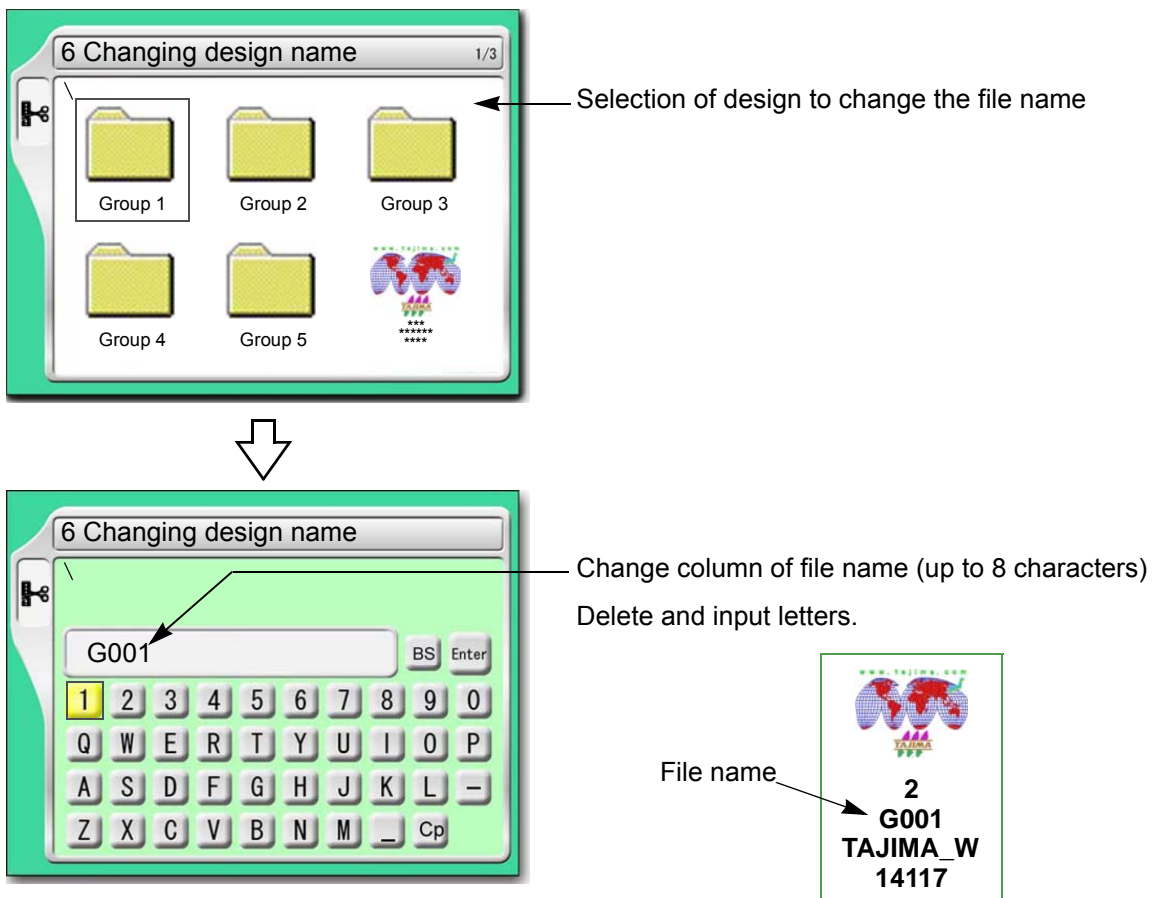

1-4-1. How to operate

The following is an example of changing the file name from "G001" to "A10".

(1) To open screen



(2) To select a design

The operation differs depending on the storing place of the design.

(a) Design in folder



(b) Design on screen

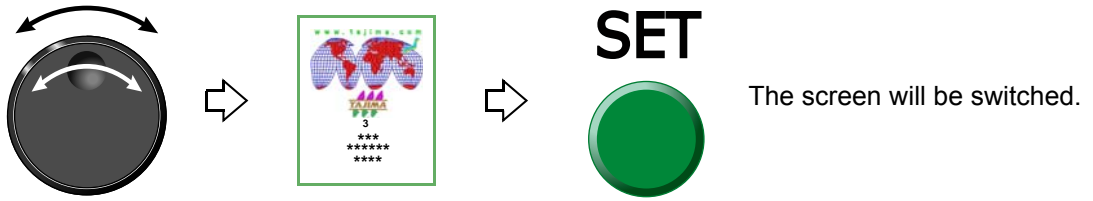

(3) To change file name

(a) To return the cursor to the top of the file name

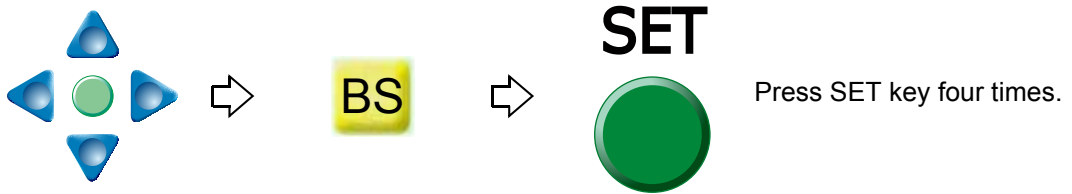

(b) To select "A"



(c) To select "1"



(d) To select "0"

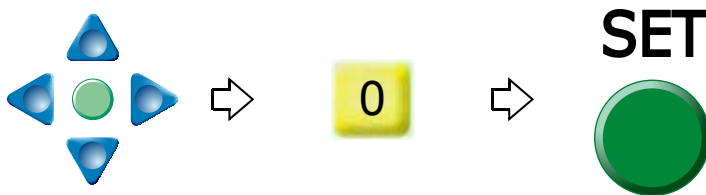

(e) To select "Enter" and decide

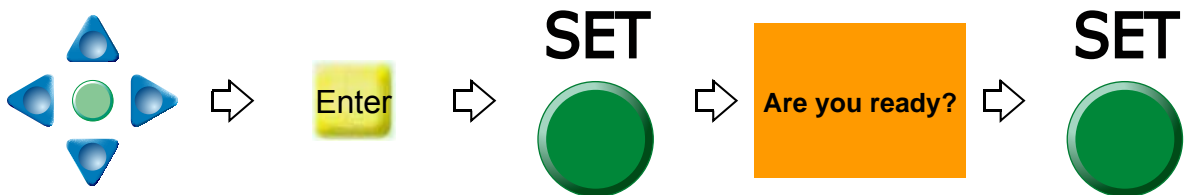

1
2
3
4
5
6
7
8
9
10
11

1-5. To change a folder name (Changing folder name)

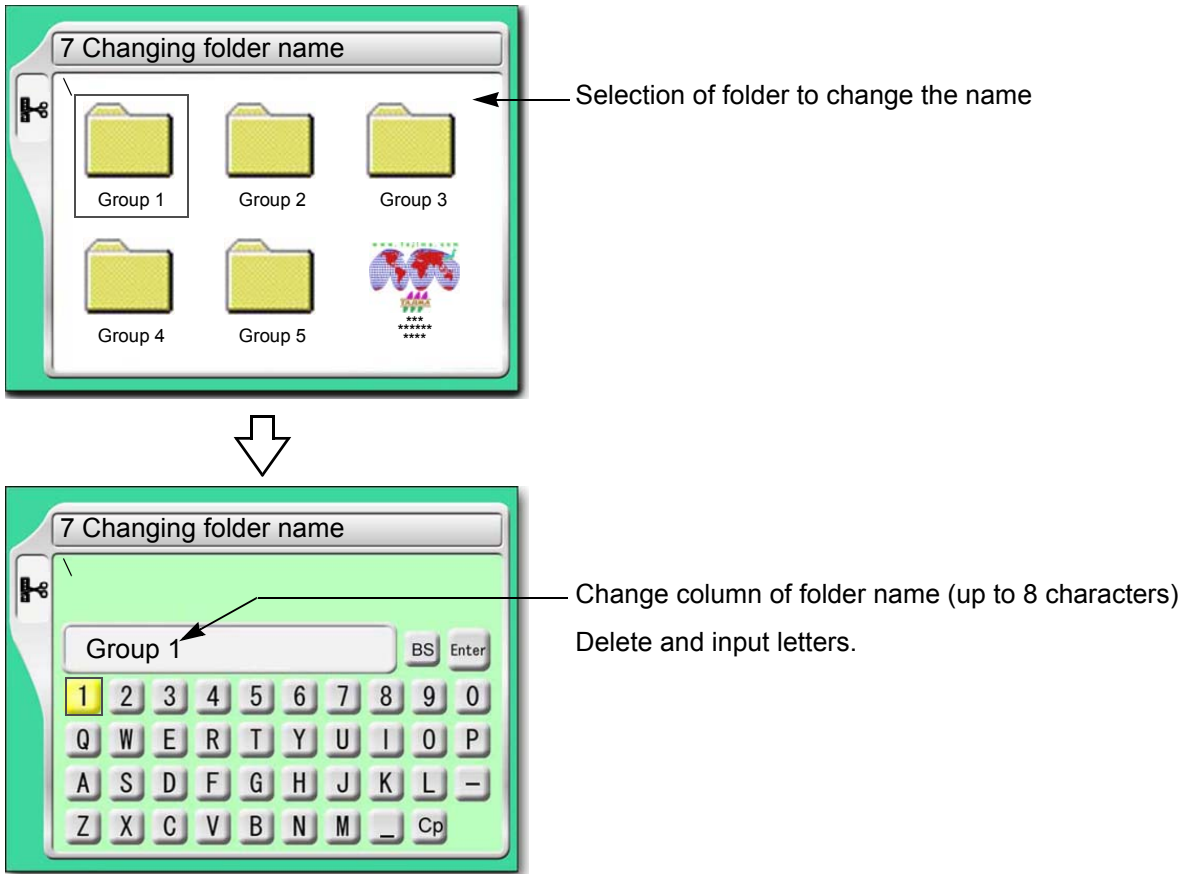

1-5-1. How to operate

The following is an example of changing the folder name from "Group 1" to "Design1".

(1) To open screen

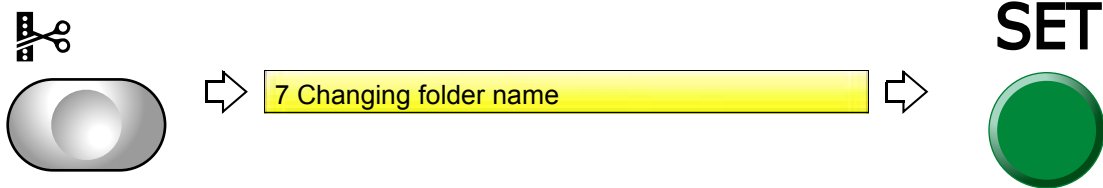

(2) To select a folder



(3) To change a folder name

(a) To return the cursor to the top of the folder name



(b) To select "D"



(c) To set to make small letters possible to be input



(d) To select "e"

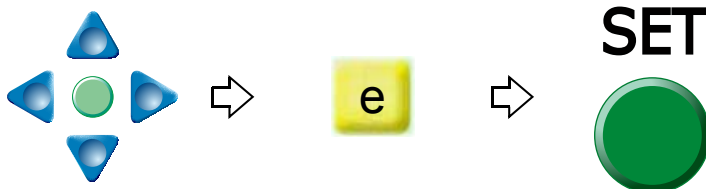

(e) To select "s"



(f) To select the remaining character (ign 1) similarly.

(g) To select "Enter" and decide

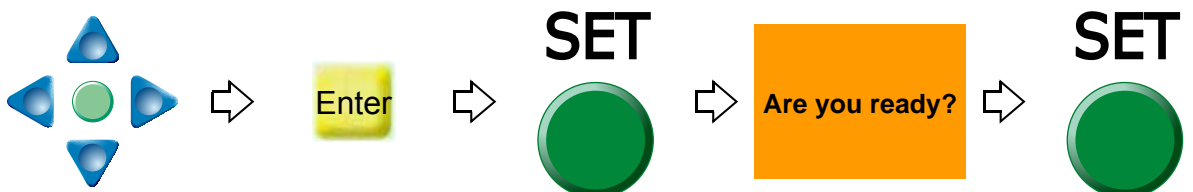

- 1
- 2
- 3
- 4
- 5
- 6
- 7
- 8
- 9
- 10
- 11

1-6. To sort a design (Design sort "in memory")

This function sorts designs in the machine memory by turns from the front. The folder will be displayed in advance of design.

1-6-1. Screen

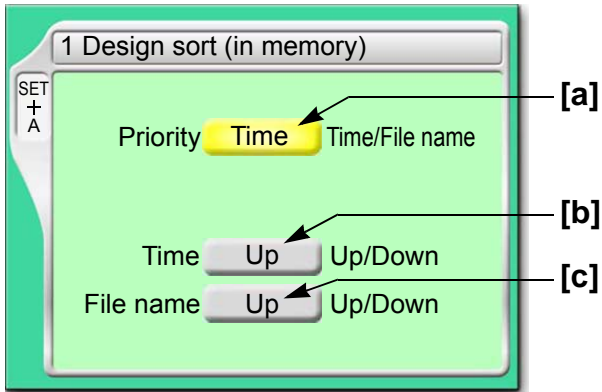

[a] Priority to sort

Time

It gives priority to updated time. When selecting "Time", perform the setting of the following [b].

File name

Give priority to the file name of the design. When selecting "File", perform the following setting [c].

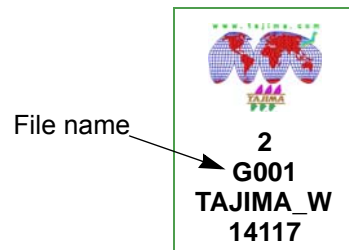

[b] Sorting method in "Time"

Up: Old → New

Down: New → Old

[c] Sorting method in "File Name"

Up: Digit/Symbol → ABC

Down: ABC → Digit/Symbol

1-6-2. How to operate

The following is an example of setting sort of the design giving the priority to "Time" and to "New → Old".

(1) Set to main screen.

(2) To press A key while pressing SET key, and press SET key further

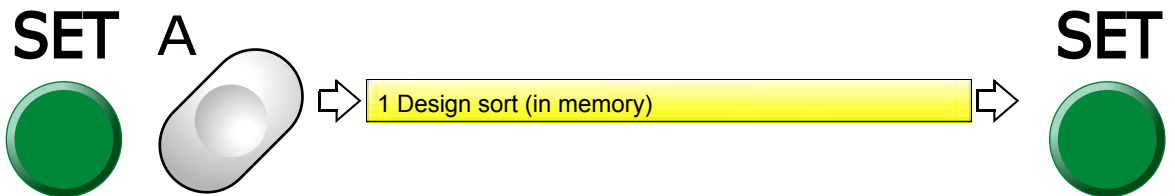

(3) To select priority to sort



(4) To select sorting method

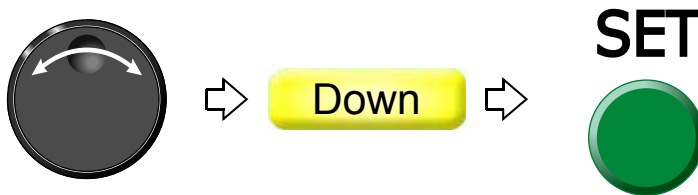

1
2
3
4
5
6
7
8
9
10
11

1-7. To store a design to a USB memory (USB "Save")

This operation requires input of the password.

1-7-1. Screen

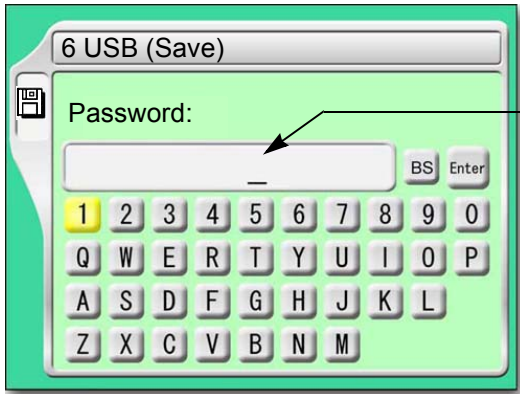

Inputting column of password

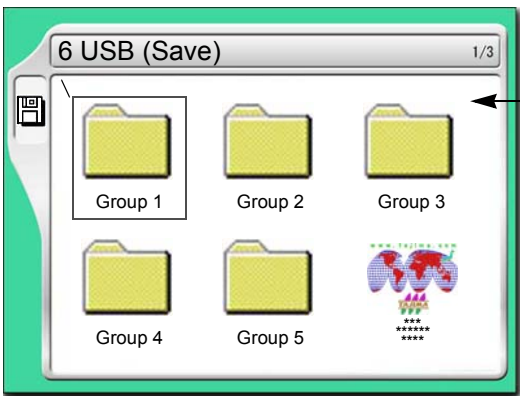

Selection of design to store into the USB memory

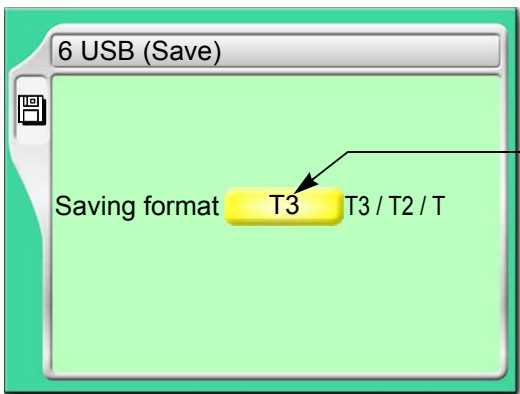

Saving format to USB memory
Usually, select "T3".

1-7-2. How to operate

The following is an example of saving designs into the USB memory.

(1) To set USB memory

(2) To open screen

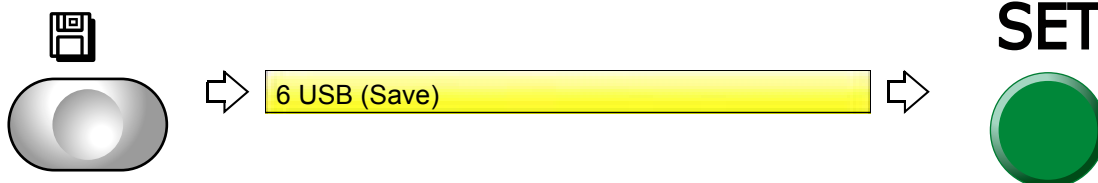

(3) To cancel the password

Regarding canceling method, refer to the detail page.(→p.135)

(4) To select a design

The operation differs depending on the storing place of the design.

(a) Design in folder



(b) Design on screen



(c) To select "Enter" and decide

When changing the file name, refer to the detail page.(→p.176)



(5) To select saving format to USB memory and decide

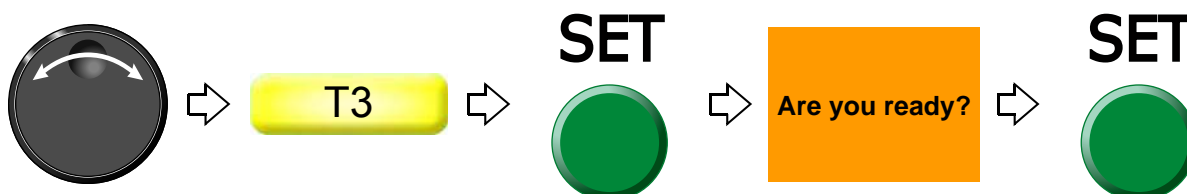

2. Design saved in USB memory

2-1. To delete a design (USB Delete)

2-1-1. Screen

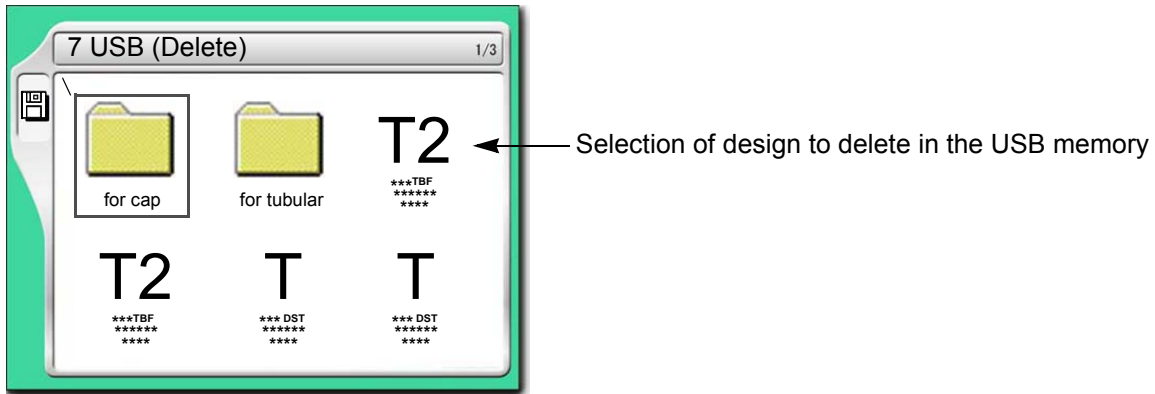

2-1-2. How to operate

The following is an example of deleting a design.

(1) To set USB memory

(2) To open screen

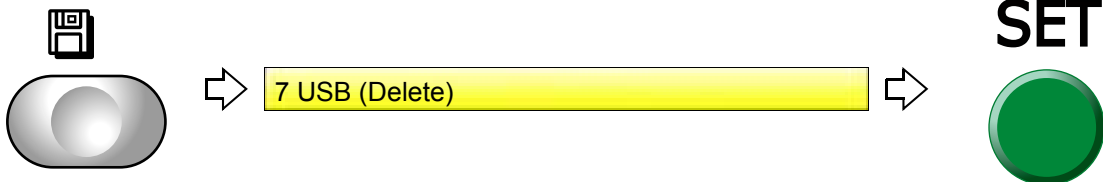

(3) To select a design

The operation differs depending on the storing place of the design.

(a) Design in folder



(b) Design on screen

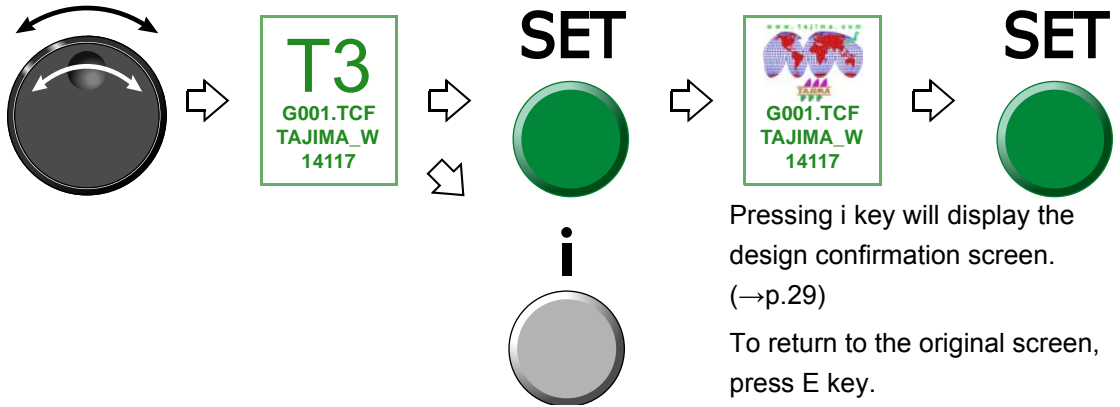

(4) To delete

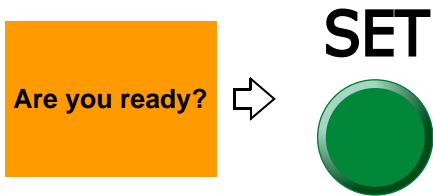

- 1
- 2
- 3
- 4
- 5
- 6
- 7
- 8
- 9
- 10
- 11

2-2. To sort a design (Design sort "USB") This function sorts designs in the machine memory by turns from the front. The folder is displayed in advance of design.

2-2-1. Screen

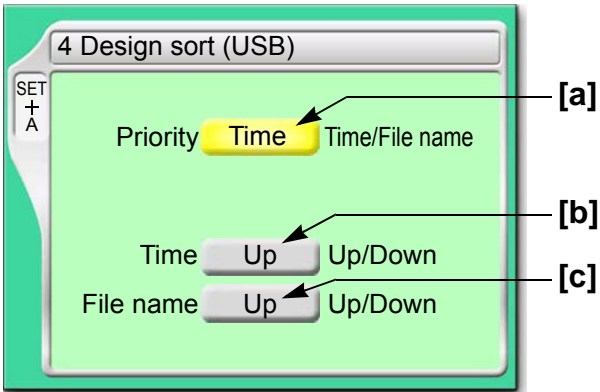

[a] Priority to sort

Time

It gives priority to updated time. When selecting "Time", perform the setting of the following [b].

File name

Give priority to the file name of the design. When selecting "File", perform the following setting [c].

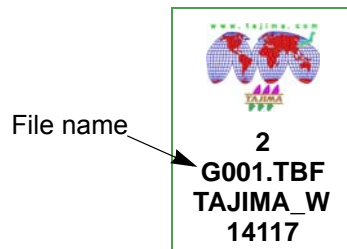

[b] Sorting method in "Time"

Up: Old → New

Down: New → Old

[c] Sorting method in "File Name"

Up: Digit/Symbol → ABC

Down: ABC → Digit/Symbol

2-2-2. How to operate

The following is an example of setting sort of the design giving the priority to "Time" and to "New → Old".

- (1) To set USB memory
- (2) Set to main screen.
- (3) To press A key while pressing SET key

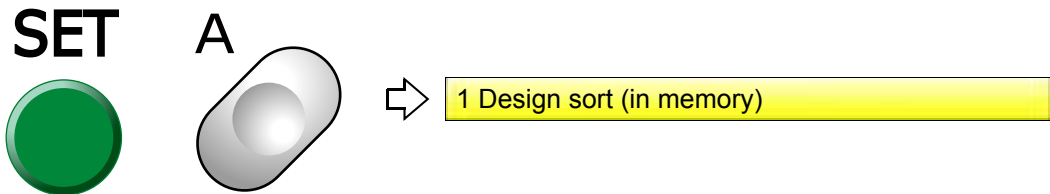

- (4) To press A key

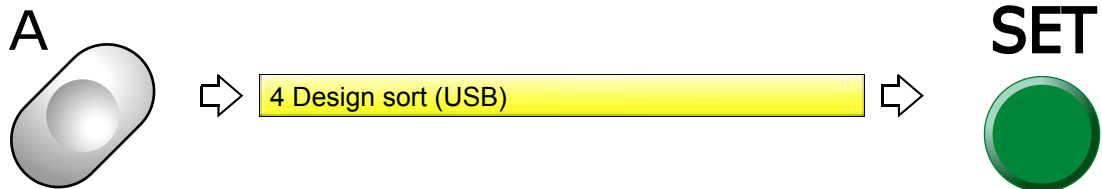

- (5) To select priority to sort

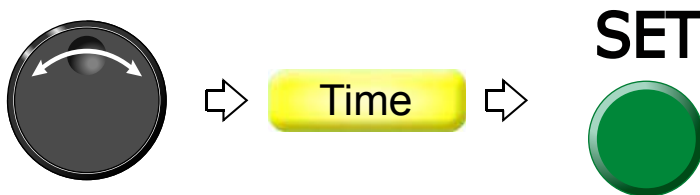

- (6) To select sorting method

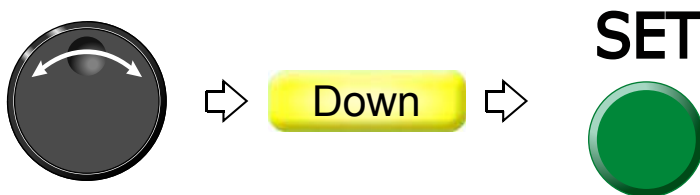

1
2
3
4
5
6
7
8
9
10
11

Chapter 8

Setting for optional device

1. To make optional device available for use.....	190
2. To set details of optional device.....	200
3. Functions concerning optional device.....	206

1

2

3

4

5

6

7

8

9

10

11

1. To make optional device available for use

Before using optional devices, be sure to check the setting condition for each device.

1-1. Sequin Device (common to III and IV)

This is a setting for making sequin device available for use. For details of the device, refer to the separate manual "Sequin Device".

1-1-1. Explanation on the screen

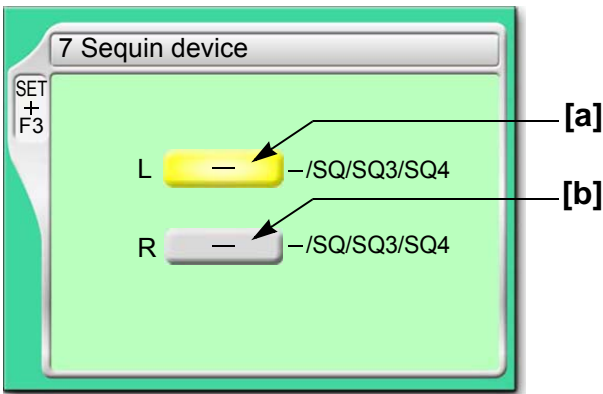

[a] Type of Sequin device equipped to left side

—: Not to use the device

SQ: High speed Sequin device

SQ3: Sequin device III (Up/down-by-motor type)

When you select "SQ3" in TFMX-C, TWMX-C, color change speed will become 1/2 of normal speed.

SQ4: Sequin device IV (Up/down-by-air type)

Air compressor is required.

[b] Type of Sequin device equipped to the right side

The contents of settings are the same as [a].

1-1-2. How to operate

The following is an example of equipping Sequin device III to the left side.

(1) Set to main screen.

(2) To press F3 key while pressing SET

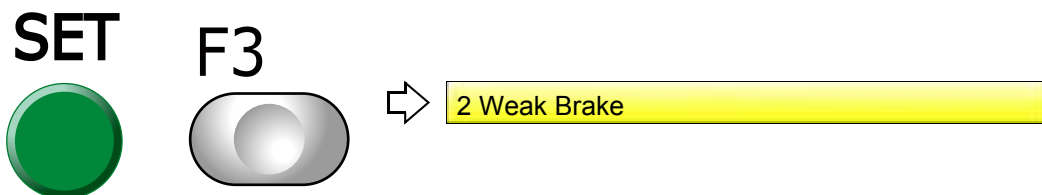

(3) To press F3 key

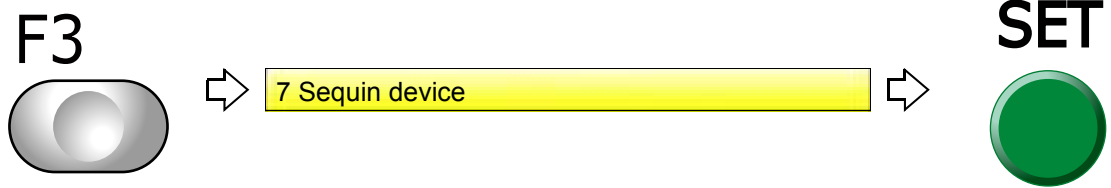

(4) To select type of sequin

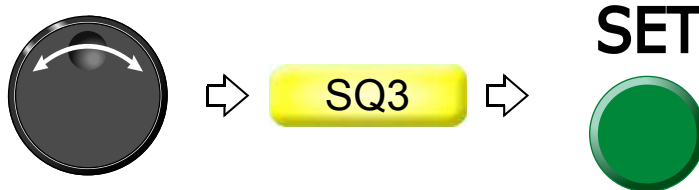

Proceed to the following operation continuously.

When selecting "SQ3", proceed to "2-1. Sequin Device III" (→p.200)

When selecting "SQ4", proceed to "2-2. Sequin device IV" (→p.204)

1
2
3
4
5
6
7
8
9
10
11

1-2. Automatic Lubrication System

This setting makes Automatic lubrication system available for use. For details of the device, refer to the separate manual "Automatic lubrication system".

1-2-1. Screen

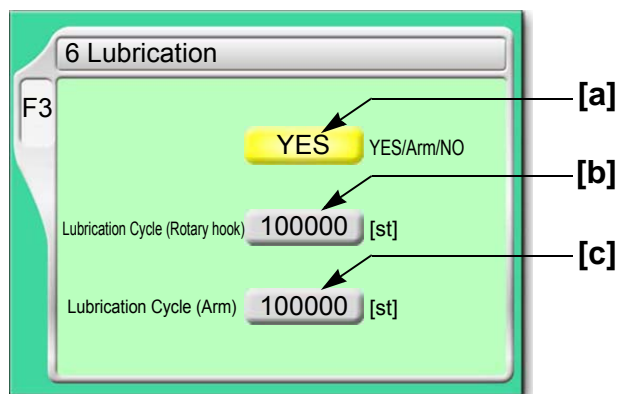

[a] Type of device

YES: Type to lubricate the inside of arm and rotary hook (LB I)

Arm: Type to lubricate to inside of the arm only (LB II)

NO: Without device

[b] Lubrication cycle to rotary hook

When counting reaches the number of set stitches, the machine will lubricate the rotary hook (recommended value: 50000).

[c] Lubricating cycle to inside of the arm

When counting reaches the number of set stitches, the machine will lubricate to the inside of the arm (recommended value: 150000).

-: Not to lubricate

1-2-2. How to operate

The following is an example that the lubrication cycle of the rotary hook is set to "50000" in case of type to lubricate both the inside of arm and rotary hook.

(1) To open screen

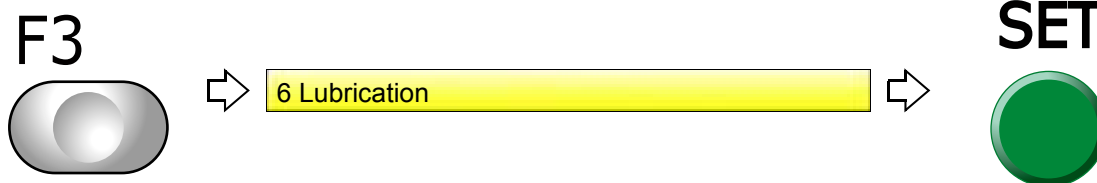

(2) To select type of device



(3) To select lubrication cycle to rotary hook



1-3. Network

This is the setting to make the network available for use by LAN connection.

1-3-1. Screen



↑
NO: Not to connect

Normal:

Input the design from DG/ML by Pulse or Autograph.

Auto-Load:

Input the design from DG/ML by Pulse in the order of output stand-by.

Sidekick:

Input the design data from Sidekick.

1-3-2. How to operate

The following is an example of inputting a design from "DG/ML by Pulse" with "Normal".

(1) Set to main screen.

(2) To press F3 key while pressing SET

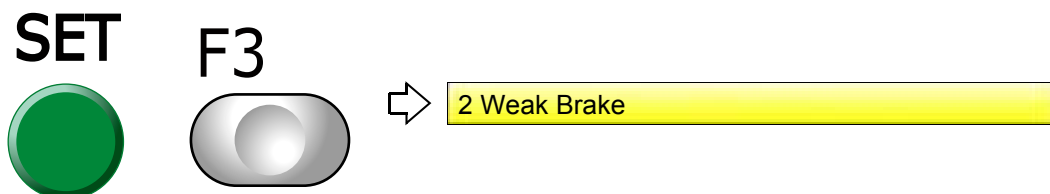

(3) To press F3 key

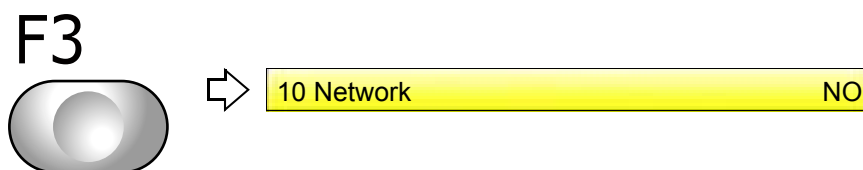

(4) Input a design with "Normal"

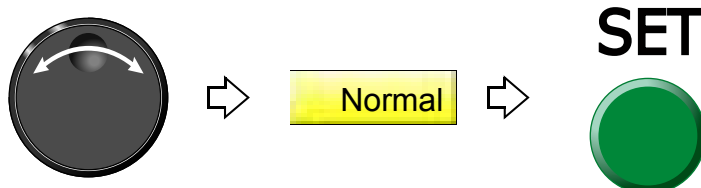

1-4. Lochrose embroidery device

This setting makes Lochrose embroidery device available for use. For details of the device, refer to the separate manual "Lochrose embroidery device".

1-4-1. Screen

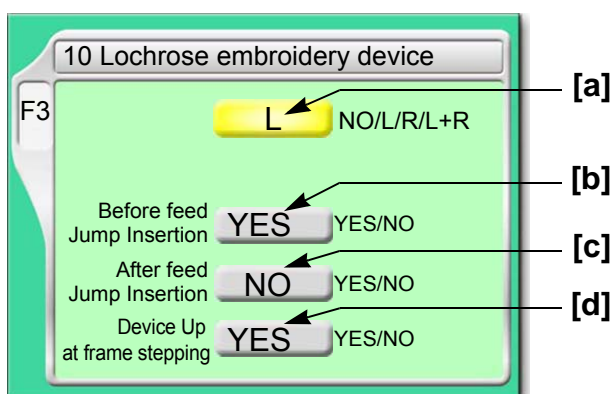

[a] Type of device

- L: Equipped to left side
- R: Equipped to right side
- L+R: Equipped to left and right side
- NO: Not to equip

[b] Insert jump before feeding material

Setting whether or not to insert a non-data jump code automatically before feeding out beads

YES: To insert

When beads can not be sewn effectually, select "YES". However, productivity will be decreased.

NO: Not to insert

[c] Insert jump after feeding material

Setting whether or not to insert a non-data jump code automatically after feeding out beads

YES: To insert

When you desire to tighten stitching tension of beads, select "YES". However, productivity will be decreased.

NO: Not to insert

[d] Moving up of device at frame stepping

YES: To perform

NO: Not to perform

! CAUTION

! Selecting "NO" will increase manufacturing efficiency. However, the device could interfere with the frame resulting in its breakage depending on design or frame type to use.

1-4-2. How to operate

The following is an example that the device is equipped to the left side and Jump is set to "To insert" before feeding out beads.

(1) To open screen

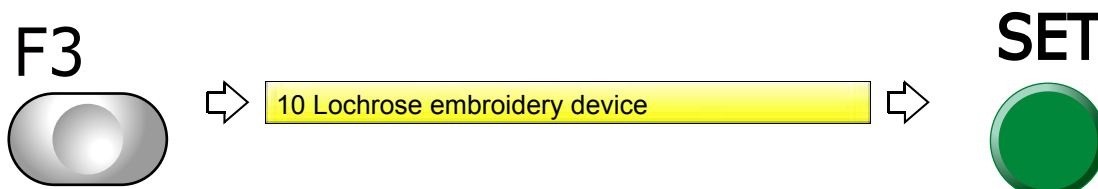

(2) To equip to left side

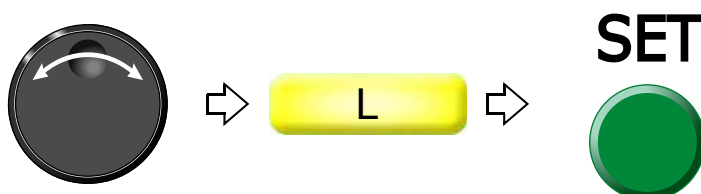

(3) To insert non-data jump code automatically



Proceed to "To make the air compressor available for use (Air Pressure Sensor)" continuously. (→p.206)

1-5. Cording Device

This is a setting for making coding device (KB-2M) available for use. For details of the device, refer to the separate manual "KB-2M (L&R)".

1-5-1. Screen

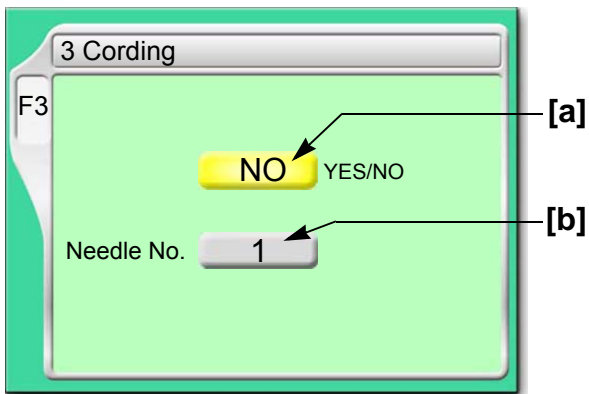

[a] Use of the device

YES: To use

NO: Not to use

[b] Equipped needle bar position

1(st needle): Equipped to the right side

12 (th needle): Equipped to left side (in case of 12-needle machine)

The last needle will be displayed.

1-5-2. How to operate

The following is an example of equipping Cording device to the left side.

(1) To open screen

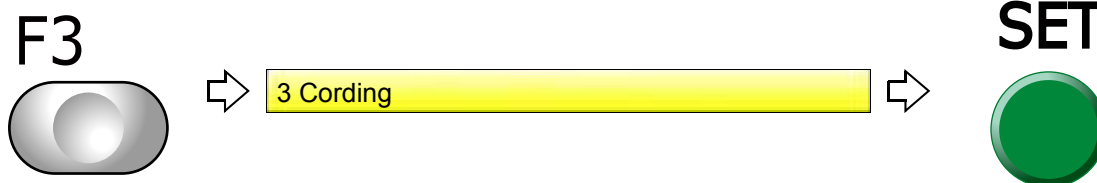

(2) To use cording device



(3) To select the needle bar No.

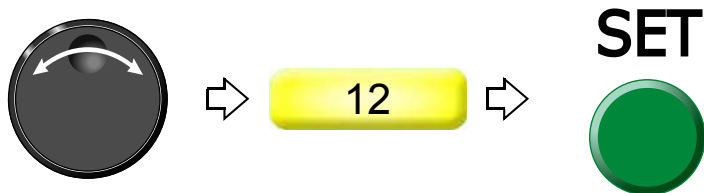

1-6. Boring Device II

This is a setting for making Boring device available for use. For details of the device, refer to the separate manual "Boring device II".

1-6-1. Screen

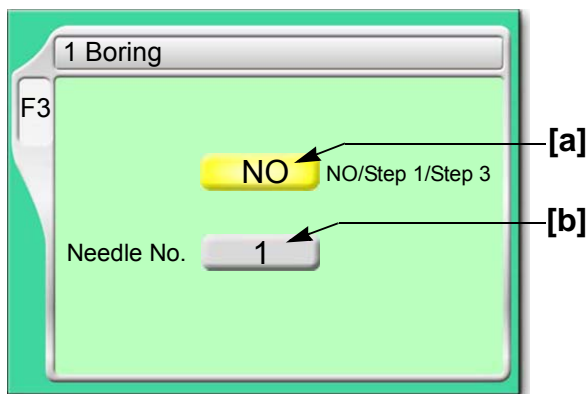

[a] Setting of Boring

Value	Device	Frame Travel ^[*1]	Scale up/down, rotation, reversion of design
NO	Not to use	-	-
Step 1 ^[*2]	To use	Not to perform	Unable
Step 3 ^[*3]		To perform	Able

*1:When switching to boring, the frame will move by 12 mm in vertical direction.

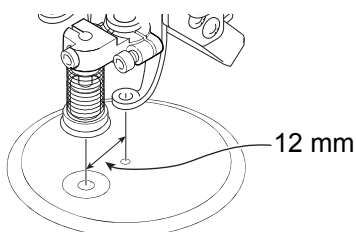

*2:Select if there is frame travel data in the design.

*3:Select if there is not frame travel data in the design.

[b] Needle bar No. equipped with device

1-6-2. How to operate

The following is an example that Boring device is set to "Step 3" and equipped to the needle bar No. "4".

(1) To open screen

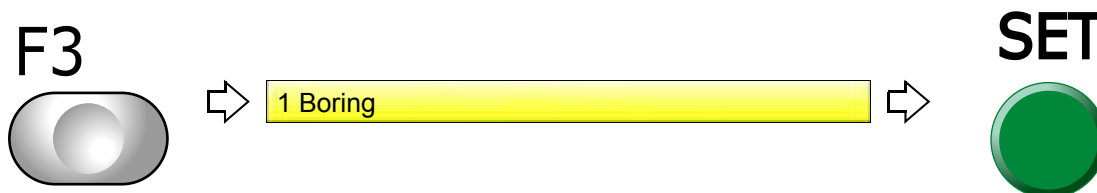

(2) To select Boring step



(3) To select the needle bar No.



1-7. Bobbin changer

This is a setting for making Bobbin changer (UBC II) available for use. For details of the device, refer to the separate manual "UBC II".

1-7-1. Explanation on the screen

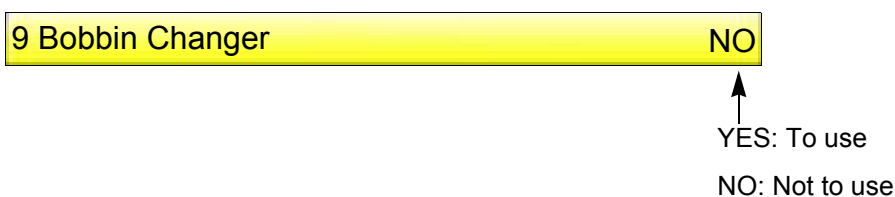

1-7-2. How to operate

The following is an example of setting Bobbin changer to "To use".

(1) To open screen

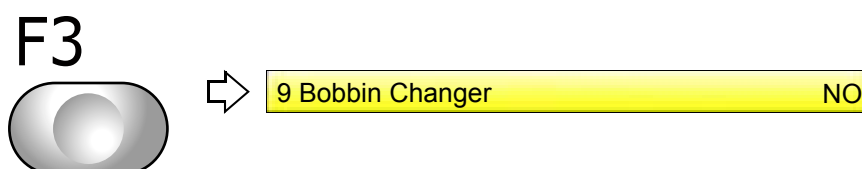

(2) To use Bobbin changer



1
2
3
4
5
6
7
8
9
10
11

2. To set details of optional device

2-1. Sequin Device III

The detail of the device will be set.

2-1-1. Explanation on the screen

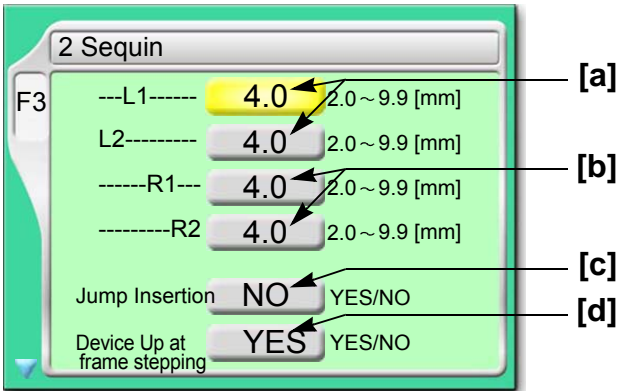

[a] Feed amount of sequin chips for each device L1 and L2 at the left side (refer to the right figure)

Select a value that adds about 1.0 to an external diameter of chip as a rough standard.

[b] Feed amount of sequin chips for each device R1 and R2 at the right side (refer to the right figure)

Select a value that adds about 1.0 to an external diameter of chip as a rough standard.

[c] Insertion of jump data when a sequin chip is sewn on

Select "YES" when sequin chips are not sewn effectually. However, productivity will be decreased.

YES: To perform

NO: Not to perform

[d] Moving up of device at frame stepping

YES: To perform

NO: Not to perform

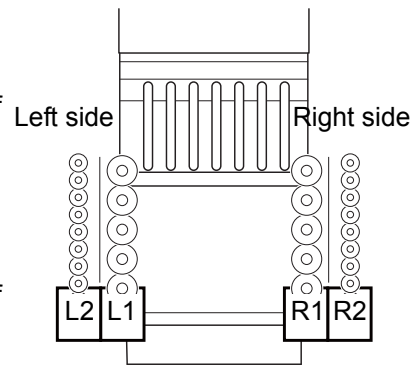

CAUTION

! Selecting "NO" will increase manufacturing efficiency. However, the device could interfere with the frame resulting in its breakage depending on design or frame type to use.

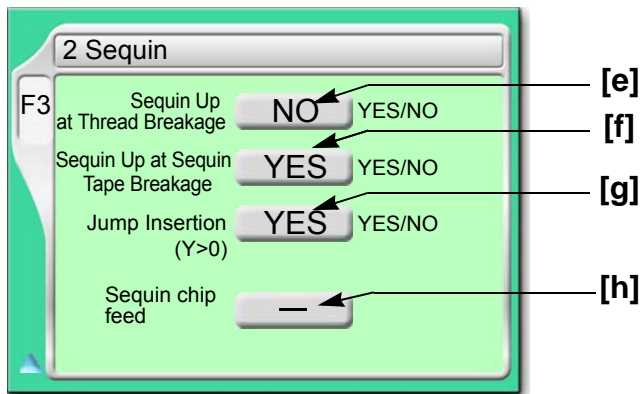

[e] Moving up of device at thread breakage

YES: To perform

NO: Not to perform

[f] Moving up of device when sequin chip runs out

YES: To perform

NO: Not to perform

[g] This setting prevents upper thread breakage by interference with device.

YES: To perform

NO: Not to perform

[h] Feed out sequin tip one by one by manual operation.(→p.203)

The feed amount is the value selected at [a] or [b] described above.

L: Left device

R: Right device

2-1-2. How to operate

The following is the example of setting in the conditions below.

Feed amount of sequin chips of device (L1) at left side: 4.0

Insertion of jump data: To perform

Moving up of device at frame stepping: To perform

(1) To open screen

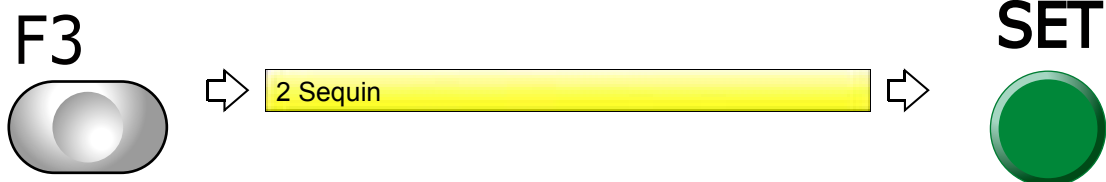

(2) To select feed amount of sequin chips of device (L1) at the left side



(3) To insert jump data



(4) To move up device at frame stepping



2-1-3. How to operate

! CAUTION

⊘ When performing this operation, do not put your hands etc. near the needle or on the machine table. Otherwise, moving up/down of the Sequin Device or moving right/left of the needle bar case could injure you.

The following is the example of feeding out sequin chips of the right side Sequin device one by one.

- (1) Set the tension base switch to "Middle" position. (It should not be suspended head.)
- (2) To open screen

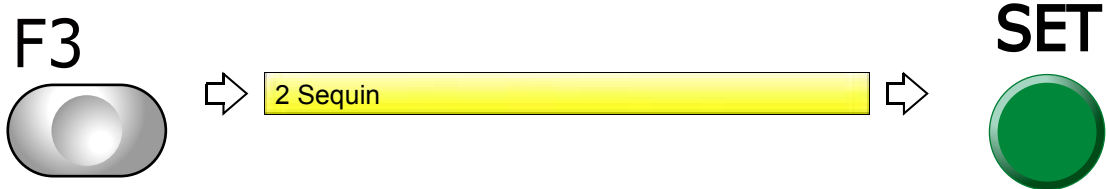

- (3) To move the cursor to "Sequin chip feed"



- (4) To select R (Right-side Sequin device)



- (5) To feed sequin chips

Every time raising the tension base switch will feed out sequin chips one by one.

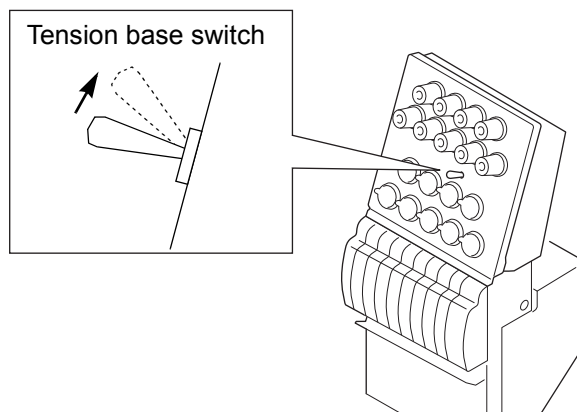

1
2
3
4
5
6
7
8
9
10
11

2-2. Sequin device IV

The detail of the device will be set.

2-2-1. Screen

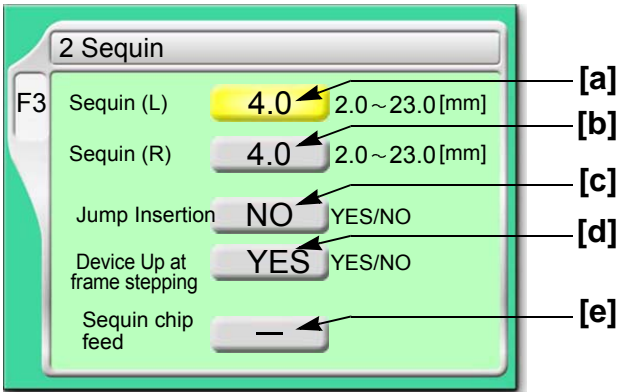

[a] Feed amount of sequin chips of device at left side

Select a value that adds about 1.0 to an external diameter of chip as a rough standard.

[b] Feed amount of sequin chips of the device at the right side

Select a value that adds about 1.0 to an external diameter of chip as a rough standard.

[c] Insertion of jump data when a sequin chip is sewn on

Select "YES" when sequin chips are not sewn effectually. However, productivity will be decreased.

YES: To perform

NO: Not to perform

[d] Moving up of device at frame stepping

YES: To perform

NO: Not to perform

CAUTION

! Selecting "NO" will increase manufacturing efficiency. However, the device could interfere with the frame resulting in its breakage depending on design or frame type to use.

[e] Feed out the sequin chip one by one manually.(→p.203)

The feed amount is the value selected at [a] or [b] described above.

L: Left device

R: Right device

2-2-2. How to operate

The following is the example of setting in the conditions below.

Feed amount of sequin chips of device at left side: 4.0

Insertion of jump data: To perform

Moving up of device at frame stepping: To perform

(1) To open screen

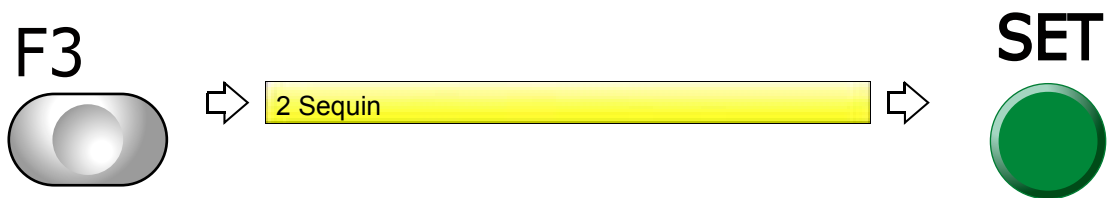

(2) To select feed amount of sequin chips of device at left side

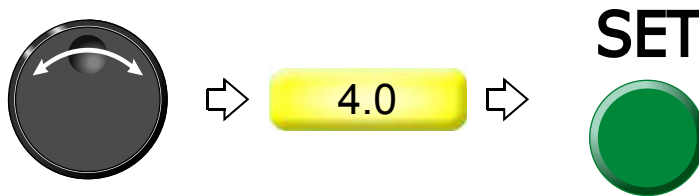

(3) To insert jump data



(4) To move up device at frame stepping



Proceed to "To make the air compressor available for use (Air Pressure Sensor)" continuously.
(→p.206)

1
2
3
4
5
6
7
8
9
10
11

3. Functions concerning optional device

3-1. To make the air compressor available for use (Air Pressure Sensor)

Set this function when the following optional devices are equipped.

Auto Clamp Frame

Sequin device IV

Lochrose embroidery device

3-1-1. Screen



↑
YES: To use air compressor
NO: Not to use

3-1-2. How to operate

! CAUTION

! When you use specified option, select "YES". Selecting "NO" could damage Sequin device and/or the machine by moving down of Sequin device when Air pressure is decreased in the middle of stitching.

The following is the example of making Air compressor available for use.

(1) Set to main screen.

(2) To press F3 key while pressing SET

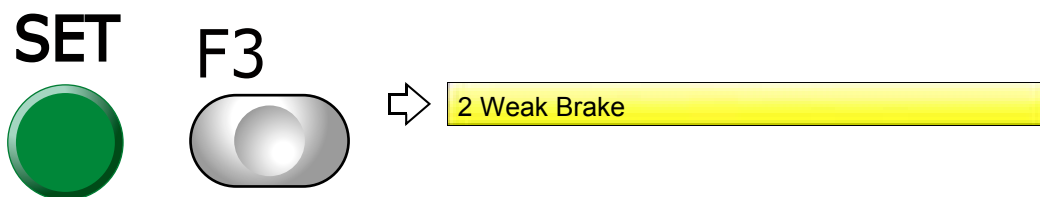

(3) To press F3 key

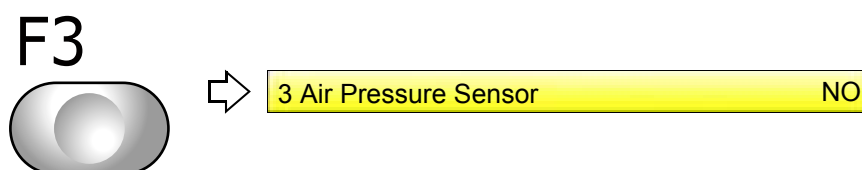

(4) To use the air compressor



3-2. To reverse the 1st color and the 2nd color in sequin device III
(Data conversion for sequin output)

This is the setting not for replacing by removing sequin but for reversing sequin on the design data all at once when you desire to replace sequin of the device L1 and L2 (the right figure). This function is effective only for the step selected with sequin needle against step of sewing sequin.

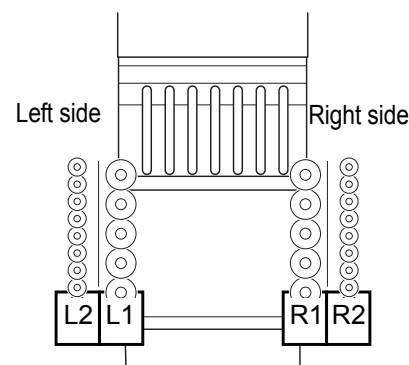

3-2-1. Screen

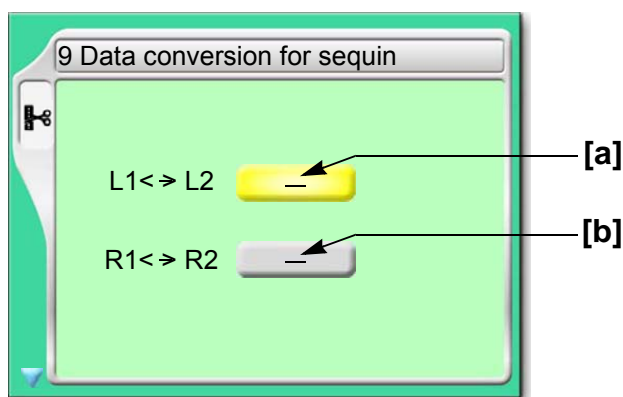

[a] The device L1 (1st color) and L2 (2nd color) at the left side will be replaced each other.
Thus, "Sequin_O" in the design data will be replaced with "Sequin_O_2" or vice versa.
Sequin_O (Sequin output): 1st color
Sequin_O_2 (Sequin output 2): 2nd color

[b] The device R1 (1st color) and R2 (2nd color) at the Right side will be replaced each other.

3-2-2. How to operate

! CAUTION

! The original design will be overwritten after editing. Back up design data according to need.

The following is an example of reversing L1 and L2 in the device at left.

(1) To open screen

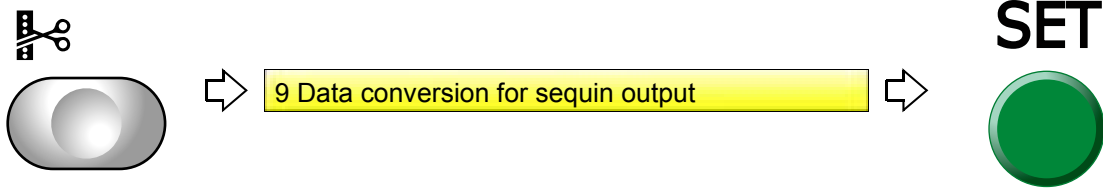

(2) To select a design



(3) To reverse

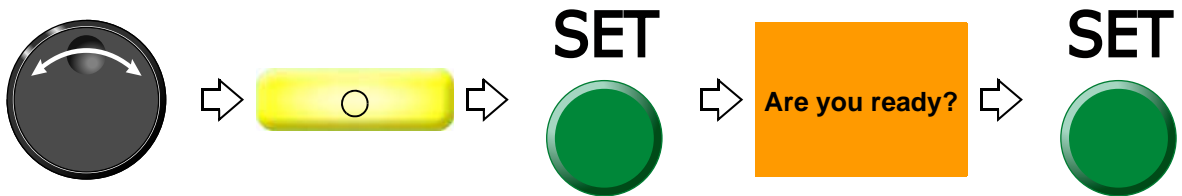

3-3. To change color by using DST design in sequin III (Needle bar selection)

This setting enables color change on Sequin device III (corresponding to sequin code Sequin_O and Sequin_O_2) by using DST design (corresponding only to sequin code Sequin_O) that is originally used for single color. After inputting data of DST design, sequin code (Sequin_O) will be allocated to "1" in the right figure. It is possible to switch "1" and "2" in unit of step by this operation.

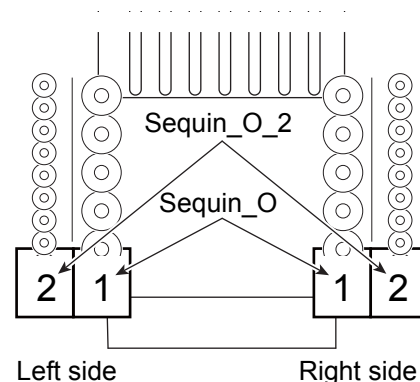

3-3-1. Explanation on the screen

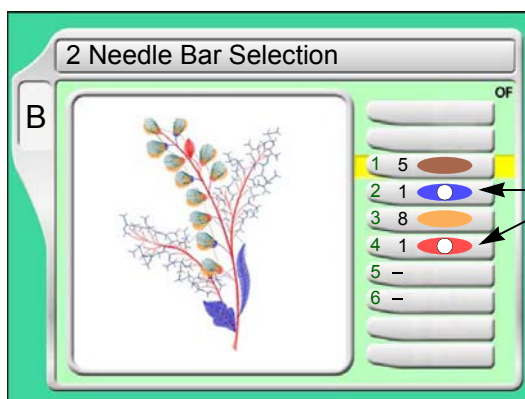

[a] Setting for color change of device

[a] Setting example of color change

Left side

In case of sewing by left side device "1"

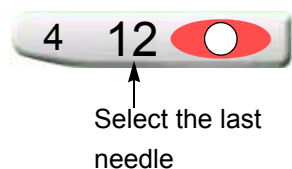

Left side

In case of sewing by left side device "2"

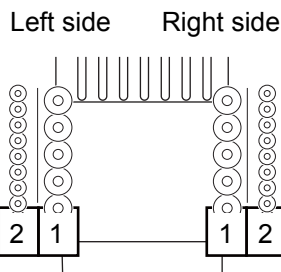
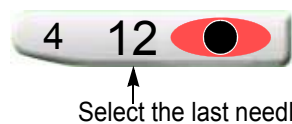

Right side

In case of sewing by left side device "1"

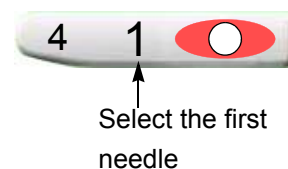

Right side

In case of sewing by left side device "2"

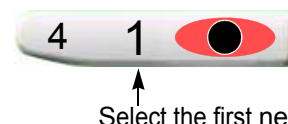

When saving data after change to the USB memory, display of "Needle Selection" on the operation panel will be switched as shown below figure. At the same time, the design data (the machine memory) will be also edited automatically, and sequin code in the design will switch from "Sequin_O" to "Sequin_O_2".



3-3-2. How to operate

The following is an example of sewing by left device "2" in step 2.

(1) To open screen

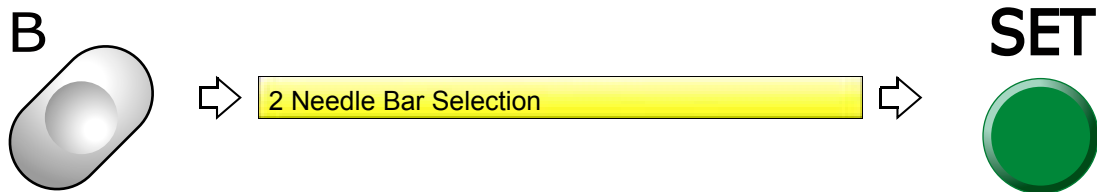

(2) To select Step 2

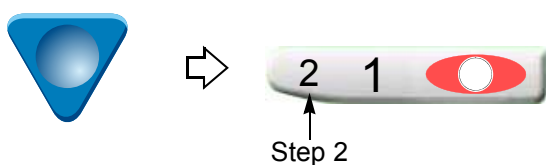

(3) To select device (last needle) at left side

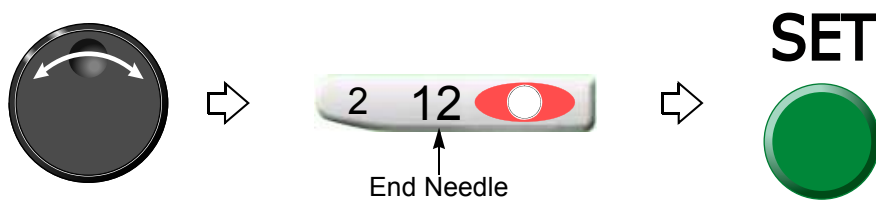

(4) To select device "2" (black dot)

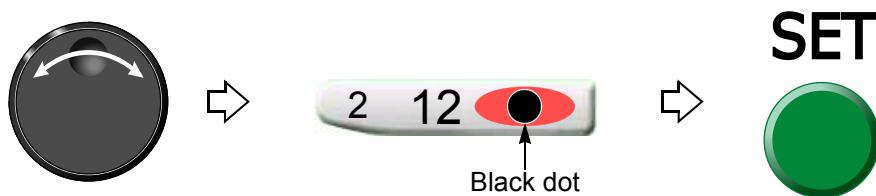

3-4. Lochrose counter

Display remaining number of beads for each head.

3-4-1. Screen

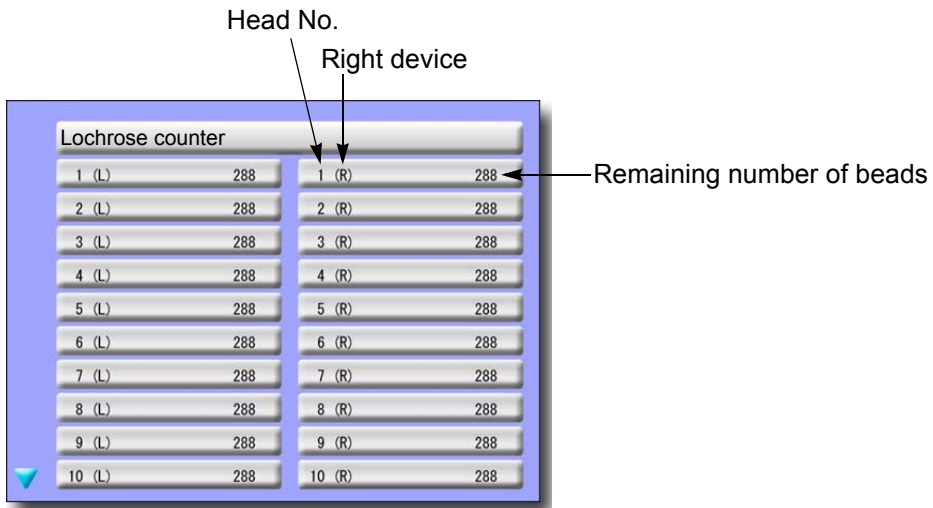

3-4-2. How to operate

Press i key until the screen shown above will be displayed.

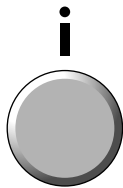

1
2
3
4
5
6
7
8
9
10
11

Chapter 9

Countermeasure when some trouble occurs in the machine

- 1. Countermeasure when the machine stopped214
- 2. Trouble examples and Corrective actions221

1

2

3

4

5

6

7

8

9

10

11

1. Countermeasure when the machine stopped

When the machine stops during embroidery, a code No. indicating stop factor will be displayed on the screen (the illustration below is an example).

Restoring method differs depending on the code Nos. described.

1-1. Normal stop

It is displayed in green on the screen. It is not a stop by abnormality of the machine.

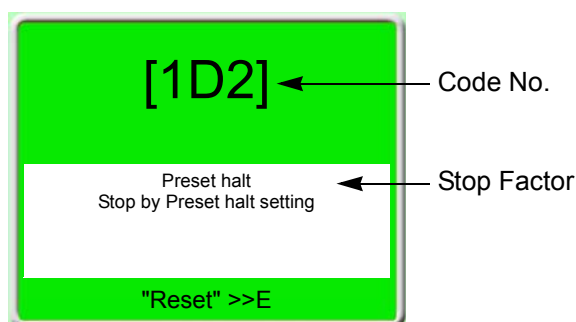

The list below also includes code Nos. which are not displayed (common to the models).

No.	Stop Factor	How to restore
1B1	Stop by frame stepping code	Perform "Start operation" or "Frame back/forward operation", or press any operation key (excluding manual frame travel key) to continue operation of the machine.
1B2	Stop by color change code	
1B3	Stop by end code	
1B4	Stop by thread trimming code	
1B6	Stop by automatic color change (free setting) offset code	
1B8	Stop by temporary stop code	
1C1	Stop by stop switch during frame stepping	Start to the machine.
	Stop by stop switch during trace	To start the operation again, press SET key. To reset the setting, press E key.
	Do not turn OFF the power during display of 1C1. It may not possible to continue embroidery if the power is turned OFF.	
1D1	Stop at all-head sewing start point after frame back	Start the machine and continue embroidery.
1D2	Stop by preset halt (except oil, lochrose)	Press the E key.
1D5	Stop by Preset halt (run out of beads)	
OIL	Preset halt (Oil)	Lubricate to the necessary spots, and press E key.

1-2. Abnormal stop

It is displayed in red on the screen. The trouble will occur when the movement of the machine comes off from normal position etc.

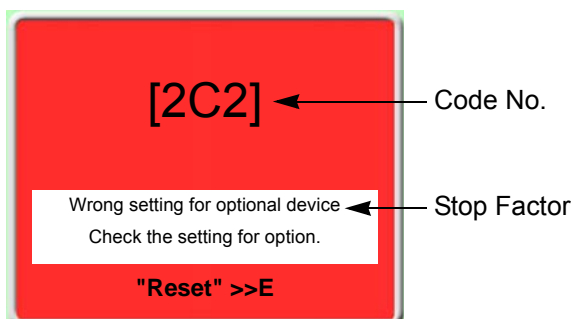

No.	Stop Factor	How to restore
211	The main shaft has stopped deviating from the fixed position.	Return the main shaft to the fixed position. Check the main shaft fixed position sensor.
221	The embroidery frame moved to the travel limit position (left) (-X direction).	Move the frame manually so that embroidery can be performed within the set range. *Only the model that has limit switch at drive system is applicable.
222	The embroidery frame moved to the travel limit position (right) (-X direction).	
223	The embroidery frame moved to the travel limit position (front) (+Y direction).	
224	The embroidery frame moved to the travel limit position (rear) (-Y direction).	
225	The frame move to the limit position during trace.	Press the E key. Check the current frame position.
	The frame moved to the software limit position during trace.	Press the E key. Check setting range of software frame limit.
228	Table up/down operation was performed when the frame was positioned at the front.	Move the frame to the rearmost position.
229	The machine was stopped during Power resume.	Perform Power resume again.
251	Oil of lubricating pump is lacking.	Lubricate to the lubrication tank.
258	Upper dead point sensor error (Sequin device III)	Check the sensor.
259	Lower dead point sensor error (Sequin device III)	Check the sensor.
25A	Sequin color change sensor error (Sequin device III)	Check the sensor.
291	Upper thread breakage is detected.	Check thread.
	TC sensor card error	Replace TC sensor card.
293	Under thread breakage is detected.	Check under thread.
294	Absence of sequin material is detected (Sequin device III only).	Check the material.
2B1	Network does not work normally.	Check connecting status of cable, setting status of device such as personal computer.

No.	Stop Factor	How to restore
2B3	Data exists in an end code.	Correct design data.
2B4	Function code error	
2B5	Sequin data error	
2B7	Data set is not completed.	Set data.
2BA	Memory capacity exceeded	Delete unnecessary design(s) registered in the memory.
2BB	Available range to perform frame back was exceeded.	Do not perform frame back any more.
2BC	No design is registered in the memory at all.	Register designs in the memory.
	The delete of design in process of embroidery was attempted.	To perform memory delete of design in process of embroidery, perform data input of other data or perform data input of the same design again.
	Data edit was attempted during embroidery.	Do not perform data edit during embroidery.
2BE	Start and End codes are not set as a one pair in satin conversion, sequin, boring and low speed code.	Set again so that start and end codes become as a pair.
2C1	Machine was started during setting of data edit or needle bar selection.	Start the machine after ending the setting.
2C2	Setting for option is incorrect.	Set correctly.
2C6	The machine was operated during working of bobbin changer.	Do not operate the machine during working of bobbin changer.
2C7	Wrong password is input.	After pressing E key, input the correct password.
2C8	Sleep mode key was pressed during trace.	Press the E key.
2C9	Time was changed during setting of Password (Time-based Limit).	Press the E key.
2CA	The power is not turned "OFF/ON".	Turn "OFF/ON" the power.
2CE	Stop by safety device	After removing the obstacle, press E key, then press the start switch.
2E2	Air pressure of the regulator has become lower than the rated value.	Check the air compressor. Check the origin of air supply.
2E3	Power supply failed during operation.	Perform power resume operation after turning ON the power.
B01	Abnormality occurred in reading/writing.	Copy design to a new USB memory and use it.
B04	USB memory is not inserted.	Insert.
BC1	Design tried to input is not in design spooler.	Check the condition of design spooler.
BC2	The same file name exists in USB memory.	Change the file name.
BC5	Insufficient remaining capacity of USB memory	Replace with a USB memory with enough remaining capacity.

No.	Stop Factor	How to restore
BF1	At network connection to host PC, IP address was not obtainable from DNS server.	Check IP address of DNS server. Correct "IP Setting.ini" file. Check operating condition of DNS server.
BF2	The contents of "IP Setting.ini" file for network setting was incorrect	Correct the contents of "IP Setting.ini" file.
5B1	It is not possible to input data due to abnormal contents of configuration in TCF design.	Check the design.
5C1	Data set was performed without frame origin memory after installation of software. The machine was stopped during operation of frame origin memory.	Perform frame origin memory.
5C2	Machine was started during moving up/down of sequin device.	Start the device after completion of up/down.
5C3	Setting error of sequin device III	Check the setting of panel.
5C6	General external device is operating.	Operate the machine after general external device is stopped.

1-3. Stop due to malfunction

It is displayed in red on the screen. It is caused by card, harness or communication error. If the below code No. is displayed, consult the distributor.

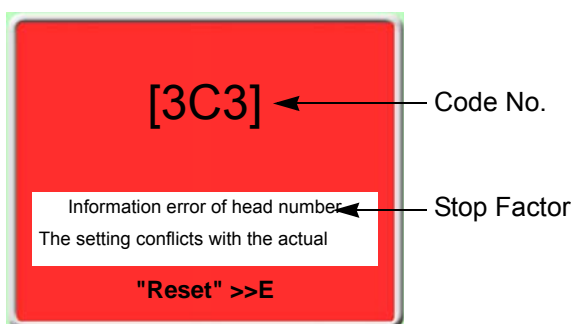

No.	Stop Factor	How to restore
311	Encoder A signal does not change for 5 seconds. Abnormality of motor, motor belt (It is not displayed for the single-head machine.)	Check connection of the encoder signal lines. Check excitation of the main shaft driver. Check the motor or motor belt.
312	Fixed position signal (Main shaft Z signal) does not change during operation.	Press the E key. Check the main shaft motor or the photo-interrupter card. When recovery is impossible, replace the main shaft motor or the photo-interrupter card.
316	Main shaft motor error or main shaft driver error	Turn "OFF/ON" the power. Or switch from sleep mode to normal mode. (Each driver setting will be reset.) When it is not possible to recover from the trouble, replace the card.
322-*	Abnormality of X-axis driver *Description of mark differs depending on factor. The same is applied to No.323.	
323-*	Abnormality of Y-axis driver	

No.	Stop Factor	How to restore
32A	The machine cannot memorize excitation of X-axis driver.	Turn "OFF/ON" the power. Check connection of each frame driver motor and/or sensor wire.
32B	The machine cannot memorize excitation of Y-axis driver.	Replace the corresponding frame driver or frame motor.
32C	Incompletion of X-axis frame travel	Turn "OFF/ON" the power. Or switch from sleep mode to normal mode. (Each driver setting will be reset.) When it is not possible to recover from the trouble, replace the card.
32D	Incompletion of Y-axis frame travel	
32E	The machine cannot complete X-axis origin search within the time.	Check setting for embroidery space at software installation. Check the sensor card.
32F	The machine cannot complete Y-axis origin search within the time.	
331	Abnormal signal of bobbin changer has been detected.	Operate the bobbin changer manually after resetting the error, and check/adjust the place where motion error occurred.
353	Abnormality occurred in up/down color change driver (Sequin device III only).	Check the card.
354	Sequin motor, color change motor, ATH motor overcurrent (Color change motor and ATH motor are applicable to single-head machine only.)	Turn OFF/ON the power. Check and/or replace the head card. Decrease rpm.
362	Jump motor overcurrent	
382	The needle position signal status during color change does not change for 1 second and more.	Check the color change motor and power supply circuit. Check the potentiometer (needle position sensor).
383	Needle position was abnormal.	Check setting for the number of needles at installation of software.
	There was no needle position signal during rotation of the main shaft.	Check the potentiometer (needle position sensor).
387	Color change motor sensor error	Check encoder signal wire of color change motor.
3A6	ATH movable knife retractable position has become nonuniform.	Check the position of ATH movable knife.
3A9	Upper thread holding motor overcurrent	Turn OFF/ON the power. Check and/or replace head card.

No.	Stop Factor	How to restore
3B5	Communication error (between CPU card USB hub), power supply system error of 280 V or 24 V, abnormality of power supply card	Check harness connection between CPU card and USB hub. Check and/or replace power supply card. Check and/or replace DC power supply.
	Wrong selection of model at installation of software	Install the software again.
3B5 MC	Communication error (among CPU card, USB hub and machine card), USB communication error due to color change position, 24 V power supply system error, power supply card error	Check harness connection among CPU card, USB hub and machine card. Check and/or replace power supply card. Check and/or replace 24 V power supply.
3B5 S	Communication error (among CPU card, USB hub and main shaft driver), USB communication error due to color change position, 280 V power supply system error, power supply card error	Check harness connection among CPU card, USB hub and main shaft driver. Check and/or replace power supply card.
3B5 X	Communication error (among CPU card, USB hub and X-axis driver), USB communication error due to color change position, 280 V power supply system error, power supply card error	Check harness connection among CPU card, USB hub and X-axis driver. Check and/or replace power supply card.
3B5 Y	Communication error (among CPU card, USB hub and Y-axis driver), USB communication error due to color change position, 280 V power supply system error, power supply card error	Check harness connection among CPU card, USB hub and Y-axis driver. Check and/or replace power supply card.
3B7	Communication error inside the controller, bad communication (between CPU card and switch card)	Turn "OFF/ON" the power. Check harness connection between CPU card and switch card. Replace CPU card or switch card.
3B8	Impossible communication with sequin device III	Check the sequin controller card or connection.
3B9	Communication error of up/down color change driver (Sequin device III only).	Check the sequin driver card (Occurred only when power is turned ON).
3BA	Communication error with sequin device III	Check the sequin controller card or connection (Occurred only when power is turned ON).
3BC MC	Communication speed error (machine card)	Check/replace machine card.
3BC S	Communication speed error (main shaft driver)	Check and/or replace the main shaft driver.
3BC X	Communication speed error (X-axis driver)	Check/replace the X-axis driver.
3BC Y	Communication speed error (Y-axis driver)	Check/replace the Y-axis driver.
3BD MC	Error of ID written to the card. Driver not for machine card is connected.	Check/replace machine card.

No.	Stop Factor	How to restore
3BD S	Refer to 3BD (MC) described above. Driver not for the main shaft is connected.	Check and/or replace the main shaft driver.
3BD X	Refer to 3BD (MC) described above. Driver not for X-axis is connected.	Check/replace the X-axis driver.
3BD Y	Refer to 3BD (MC) described above. Driver not for Y-axis is connected.	Check/replace the Y-axis driver.
3BF	Remaining number of beads cannot be grasped.	Check and/or replace the head card.
3C1	Contact error of the bar switch or start/stop switch, breakage of the switch harness, or bad connection of the connector	Check the connector and the connecting terminal. Replace the limit switch/switch assembly.
3C3	Mis-setting of the number of heads in "Machine Type"	Check the contents of setting.
3D6	There is abnormality in the program or in the CPU card.	Check the CPU card.
	The software is not installed normally.	Install the software.
3DB	Lack of system RAM capacity	Turn "OFF/ON" the power. Replace CPU card.
3DC	Abnormality of memory device	Turn "OFF/ON" the power. Install the software. Replace the DOM or CPU card.
3DD	Abnormal system installation	Install the software. Replace DOM or CPU card.
3DE	Abnormality of external memory device	Turn "OFF/ON" the power. Check/replace the USB memory, or replace the CPU card.
6D1	File error of frame drive parameter	Install the software.
6D2	Disconnection of communication line	Turn "OFF/ON" the power. Check harness connection between CPU card and USB hub. Check and/or replace power supply card. Check and/or replace DC power supply. Install the software again.
6D3	Disconnection of USB communication line in I/O card, communication error	Turn "OFF/ON" the power. Check connection of USB cable Check and/or replace power supply card. Check and/or replace DC power supply. Install the software again.

2. Trouble examples and Corrective actions

2-1. Thread breakage is highly visible.

Cause	Troubleshooting
Bad thread tension	Adjust tension. Upper thread 120 to 140 g, Under thread 20 to 30 g
Quality of thread is bad. Poor thread flow	Use good quality thread. Spray silicone.
Direction of needle is bad or needle bents.	Adjust to face to the front or to the right a bit. Replace.
Applique glue is stuck on needle.	Remove adhered glue.
Contamination, run-out of oil of rotary hook	Clean and lubricate the machine.
There are many fine stitches of 0.5 mm or less in design data.	Remove fine stitch(es).
The fabric is lifted too much against the needle plate. The fabric touches the needle plate too much.	Stretch the fabric again so that it touches needle plate lightly.
Run-out of oil of needle bar	Lubricate.
There is a scratch on the thread course.	Grind it with sandpaper etc. Replace.
Bad height of presser foot	Perform adjustment so that height fits to fabric/ material.

If the followings seem to cause the trouble, please ask the distributor for information.

- (a) The gap between rotary hook and rotary hook support is narrow. Timing between needle and rotary hook is too early or too late. Scratch, abrasion of rotary hook.
- (b) The gap between needle and hook point is not suitable. Bad adjustment of lower dead point and/or upper dead point of needle bar.
- (c) A play of rotary hook shaft is big in back and forth direction. There is a play on the fringe of the frame.
- (d) Rotation of the main shaft is not smooth. Abrasion/breakage of neighboring parts of take-up lever drive and/or needle bar drive.
- (e) A play of needle bar case (in right and left direction) is big.

2-2. Needle breaks.

Cause	Troubleshooting
Bad thread tension	Adjust tension.
Density of design data is very high.	Correct data. Delete unnecessary underlay stitching.
The material is too thick or hard.	Use material suitable for embroidery.
Bobbin is deformed and it touches the needle.	Replace the bobbin.
Bad quality of needle, mismatching to embroidery condition	Use good quality needle. Use needle that fits to embroidery condition.
Vibration of the machine is big.	Adjust leveling.

If the followings seem to cause the trouble, please ask the distributor for information.

- (a) Abrasion of needle catcher of rotary hook. The gap between needle and hook point is not suitable.
- (b) A play of needle bar case (in right and left direction) is big.
- (c) The floor vibrates. There is a play on the fringe of the frame.

2-3. Bad finishing of sewing

Cause	Troubleshooting
Bad thread tension	Adjust tension.
Quality of thread is bad. Poor thread flow	Use good quality thread. Spray silicone.
Density of design data does not match with material and/or thread.	Correct data.
Bad frame attaching and fixing of the fabric	Attach the frame correctly. Fix the fabric firmly.
Thread, needle and/or size of needle plate do not match with embroidery.	Make combination that fits to design data/material.
R.P.M. is too high.	Decrease R.P.M.

If the followings seem to cause the trouble, please ask the distributor for information.

- (a) There is a play on the fringe of frame.
- (b) Abrasion and breakage of neighboring parts of take-up lever drive and needle bar drive.
- (c) Bad take-up lever timing.
- (d) Belt tension of drive system is too strong or too weak.
- (e) Setting for the machine does not match to the embroidery condition.

2-4. To suspend the error head

When it becomes impossible to perform embroidery by all heads due to malfunctioning of tension base card, this working makes the remaining heads perform embroidery by making the head with occurrence of trouble become suspended head. It corresponds only to 2 or more head machine.

! DANGER

 To detach the wiring cover, be sure to turn OFF the power. Card that generates high voltage is attached to the back face of the square pipe. There could be danger of electric shock.

2-4-1. Working procedure

- (1) Detach the wiring cover.

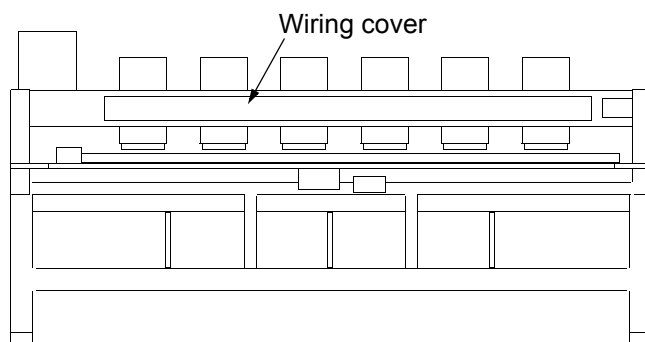

(2) Connect the jumper connector to the connector of the head card.

To suspend the third head, connect the jumper connector to the connector for odd-numbered head.

One piece of head card is used for two heads.

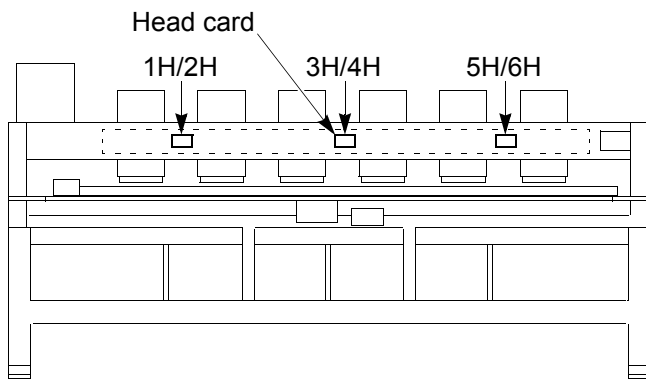
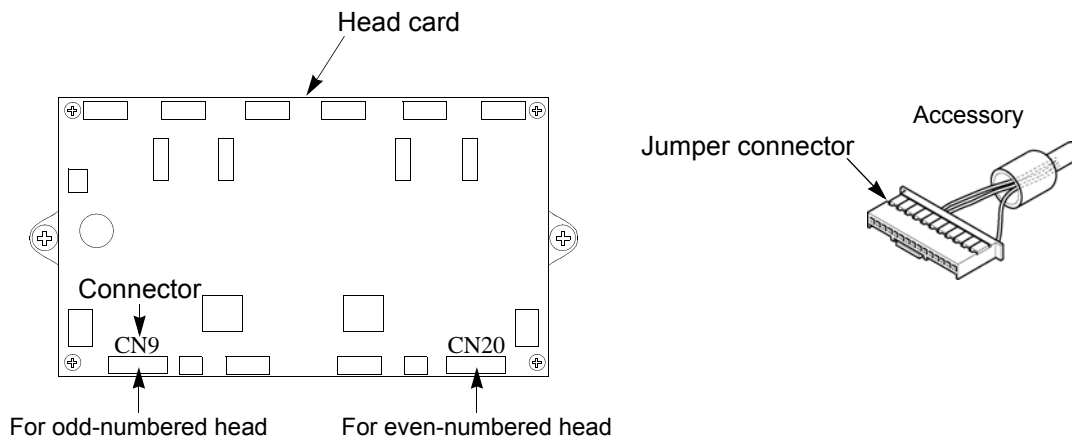

Chapter 10

Maintenance and Inspection

1. Items that must be followed carefully.....	226
2. Cleaning.....	227
3. Lubrication	229
4. Greasing	232
5. Inspection, Repair	235

1

2

3

4

5

6

7

8

9

10

11

1. Items that must be followed carefully

⚠ DANGER

⚠ The spots as shown below are attached with cards that generate high voltage. Other personnel than the service man approved by Tajima should not open the covers. You could get an electric shock of high voltage.

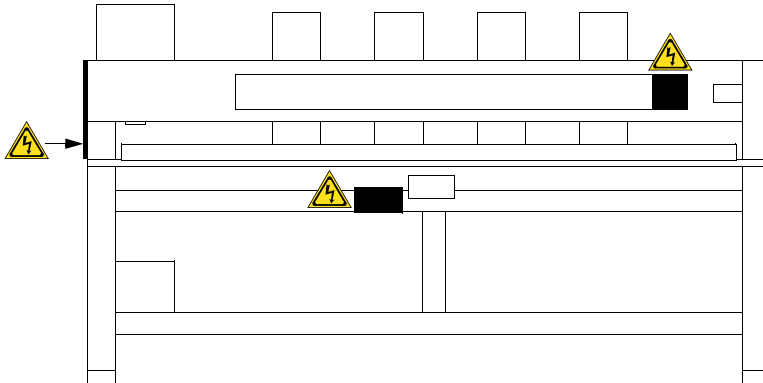

The diagram shows a side view of a machine with a top cover and a main body. Three yellow warning symbols (⚠) are placed to indicate high voltage areas: one on the top cover, one on the main body, and one on the left side panel.

⚠ WARNING

- ⓘ Daily maintenance (cleaning, lubrication, greasing, inspection) should be performed by personnel who has been trained properly.
- ⓘ "Repair" and "Replacement of electrical component" must be done only by the service personnel assigned and trained by Tajima or qualified technician. (Consult your distributor.)
- ⓘ When starting operation again, attach all the detached covers as they originally were.

⚠ CAUTION

- ⓘ Perform daily maintenance (cleaning, lubrication, greasing, inspection). Neglect of daily maintenance could cause troubles. Damage due to neglect of daily maintenance may be judged as "Outside the scope of warranty".
- ⓘ If the machine is not used for a long period, turn the power switch ON in regular intervals. Although each card of the machine has a backup battery, data may be lost for about one month because voltage of the battery will come down gradually due to discharge when power switch is turned off.
- ⓘ Assure enough illumination. Assure 300 lux or more for working areas including underneath part of the machine table when changing under threads or performing daily maintenance.
- ⊘ Do not turn ON the power with the main shaft fixed. The machine could be broken.

2. Cleaning

WARNING

 When performing cleaning, be sure to turn off the power switch. You could be injured seriously by being entangled in the machine.

Clean each section by using a commercially available cleaning tool or brush (accessory). Using of an Vacuum cleaner or an Air compressor will facilitate working.

Main cleaning spots are indicated by an arrow in the figure below. If dirt is highly visible at other spots besides these spots, clean up there accordingly.

(1) ATH, rotary hook

Cleaning cycle: Every day

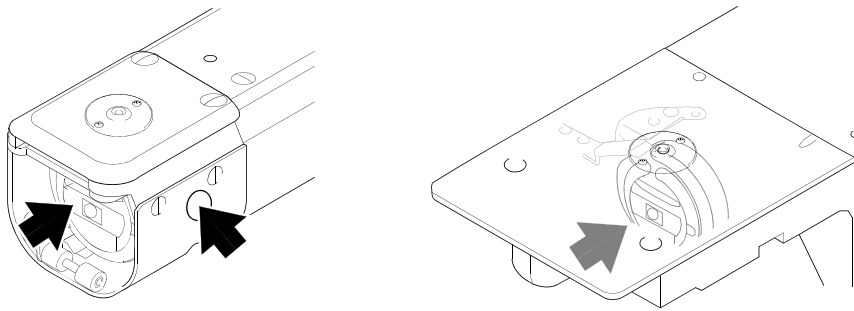

An example when using an air compressor



(2) Head

Cleaning cycle: Once a week

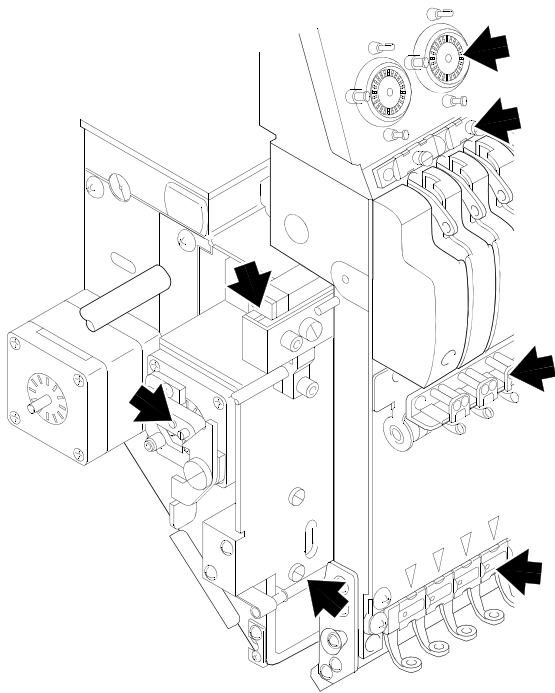

An example when using a cleaner
Brush



(3) Drive system

Cleaning cycle: Once a week

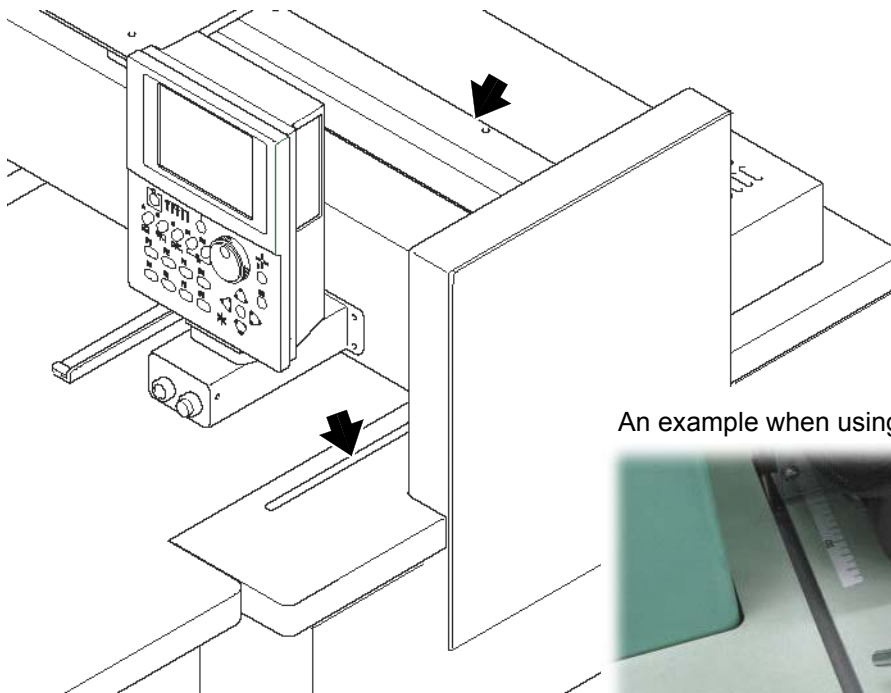

An example when using an air compressor



3. Lubrication

⚠ WARNING

! To perform lubrication of the machine, turn off the power switch. You may sustain severe injuries due to being entangled by moving machine units.

Select TF oil (packed with the machine), or the equivalent (viscosity grade = equivalent to VG20) to this one for use.

To perform lubrication, use the oiler (accessory) and its nozzle (accessory).

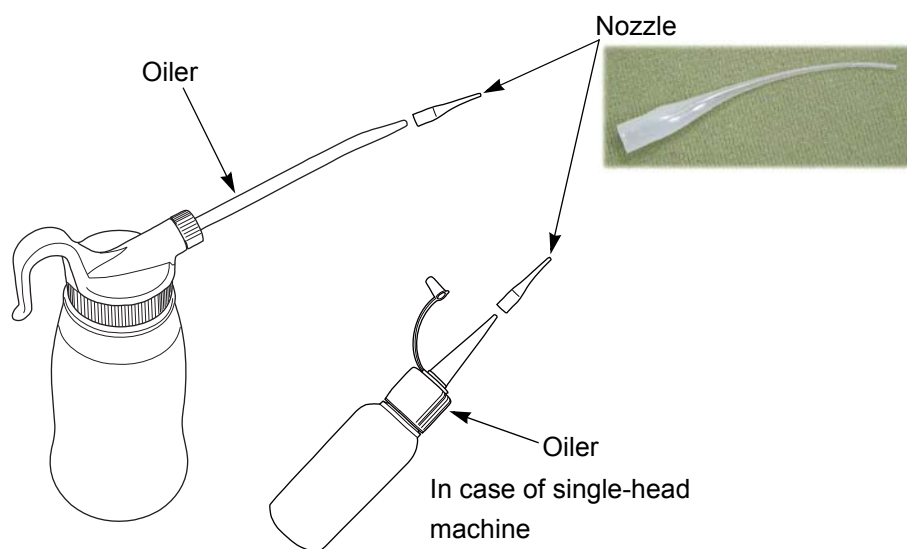

(1) Rotary hook

There are 2 lubricating spots (lubrication hole and raceway at the hook). When lubricating to the lubrication hole, attach the nozzle (accessory) to the tip of the oiler. Cut the tip of the nozzle according to necessary length.

Lubrication cycle: Once/5 to 6 hours

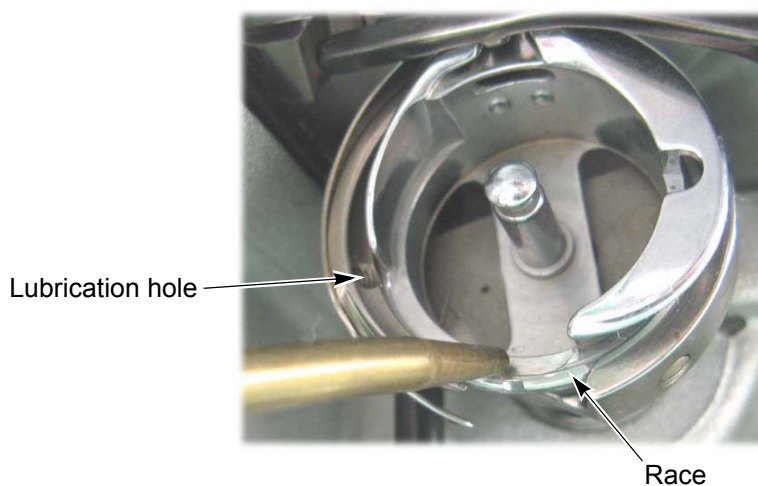

(2) Inside of head

Lubrication cycle: Once/week

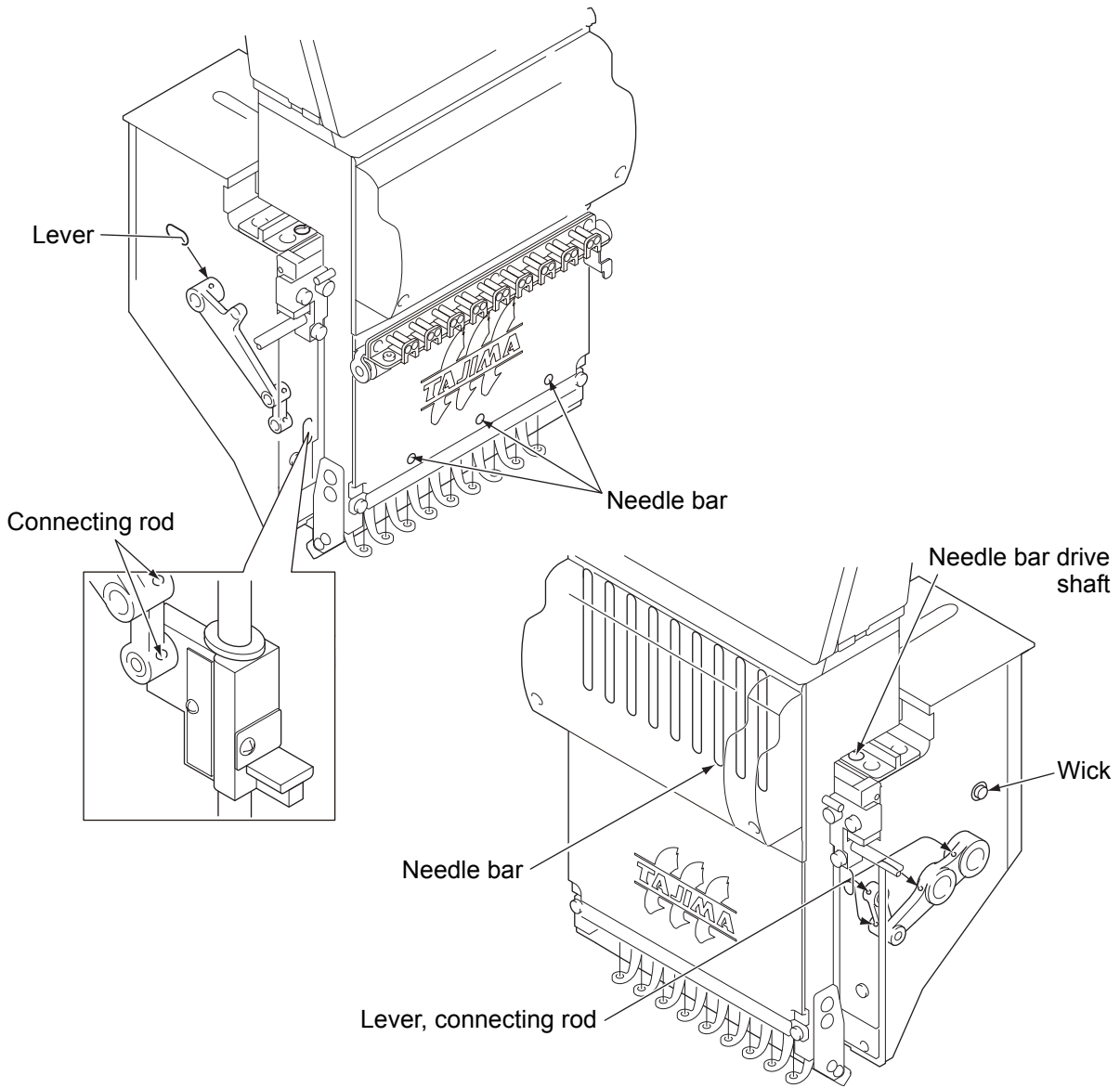

(3) Inside of cylinder bed (Single-head machine)

Lubrication cycle: Once/week

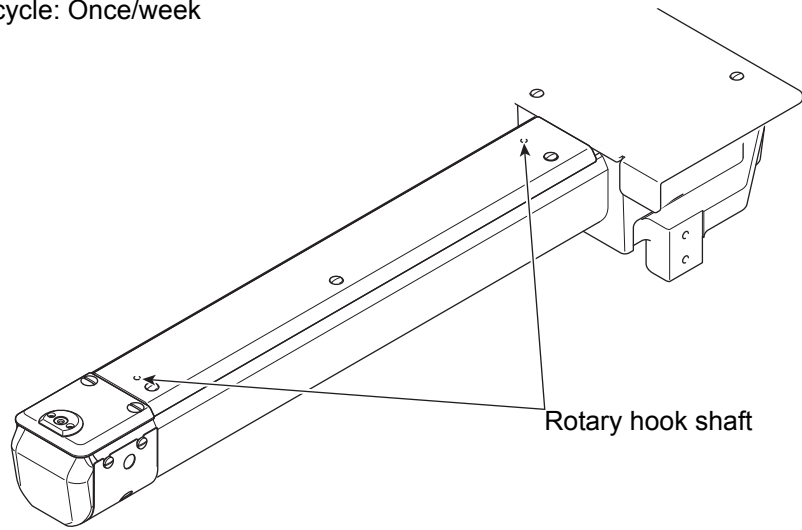
**(4) Inside of slim cylinder bed (TFMX-IIC TYPE-2)**

Lubrication cycle: Once/week

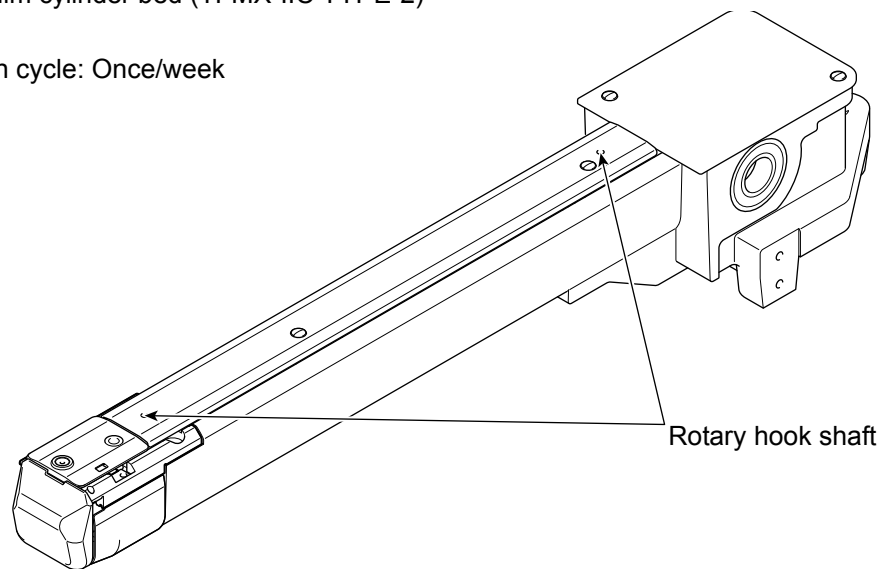

4. Greasing

 **WARNING**

 During machine greasing, turn off the power switch. You may sustain severe injuries due to being entangled by moving machine units.

 **CAUTION**

 Use a grease specified (described below) by Tajima or equivalent to keep the lubricity inside of the head normally. Use of the grease except these could cause trouble due to deterioration of the lubricity. Regarding how to obtain it, consult the distributor.

[Items specified by Tajima]

Item name	Item No.	Base oil	Thickener
GREASE :KING STAR EP NO.2 :400G	750103004000	Refined mineral oil (about 75%)	Lithium soap (about 15%)
SPRAY GREASE :NIG LUBE PG :300ML	750104001000	Olefinic synthetic oil	Lithium soap

Grease manufacturer: NIPPON GREASE CO.,LTD.

URL: <http://www.nippon-grease.co.jp/>

(1) Head

Greasing spot	Greasing cycle	Grease to use
Bearing case [*1]	Once/3 months	SPRAY GREASE :NIG LUBE PG :300ML
Roller, Cam		

*1: Grease into the hole in the bearing case by using syringe.

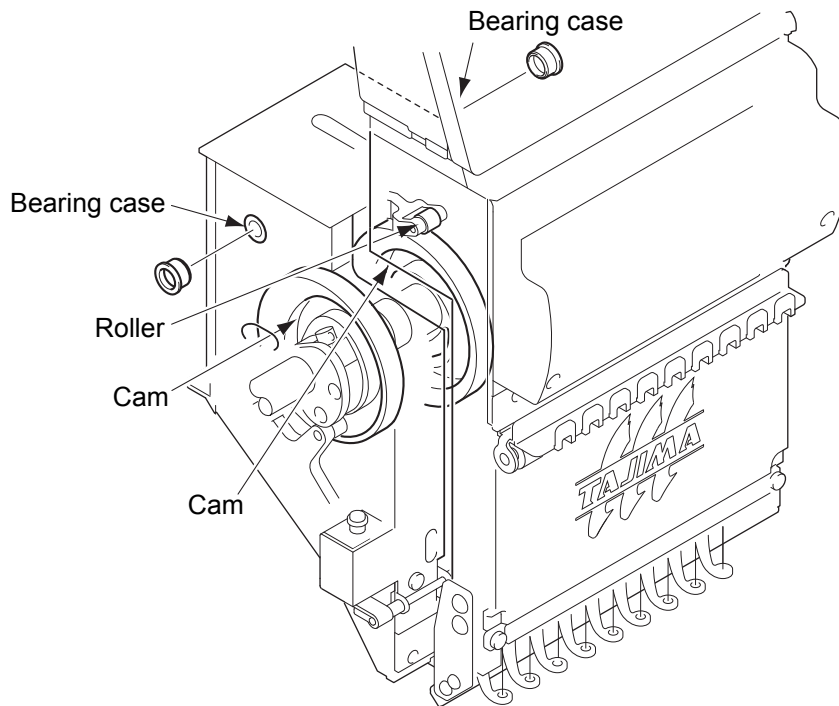
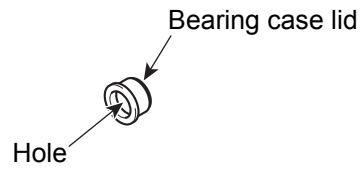

(2) Rotary hook base, Cylinder bed

Greasing spot	Greasing cycle	Grease to use
Gear	Once/3 months	GREASE :KING STAR EP NO.2 :400G

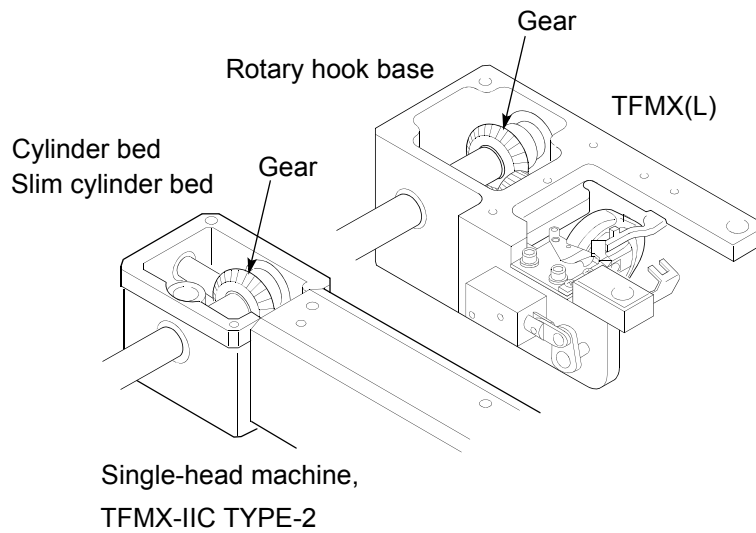

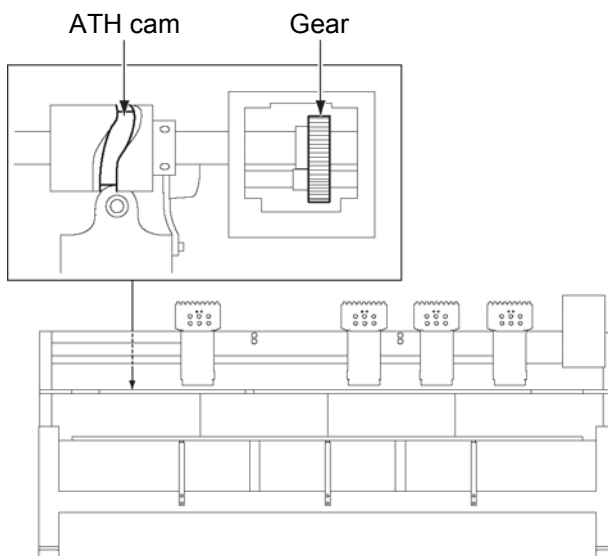

(3) ATH Cam, Gear (applicable to 2 or more head machine only)

Greasing spot	Greasing cycle	Grease to use
ATH cam, gear	Once/3 months	GREASE :KING STAR EP NO.2 :400G





5. Inspection, Repair

 **WARNING**

 Before inspection, be sure to turn off the original power supply. Some circuits are still applied voltage eve if the original power supply was turned off. Wait until these circuits are completely out of voltage (4 minutes) and then start working.

Inspection Point	Action	Inspection Cycle
Attaching of each type of cover	Attach all the covers.	At start of working
Setting condition of embroidery thread	Set it correctly.	
Check breakage and/or bent of needle.	Replace the needle.	
Lubricating condition of each section	Lubricate.	
Automatic lubrication system	Refill oil.	Once/3 months
Belt tension (main shaft, X/Y drive system)	Consult the distributor.	

 **WARNING**

 Before repairing the machine, be sure to turn off the original power supply. Some circuits are still applied voltage eve if the original power supply was turned off. Wait until these circuits are completely out of voltage (4 minutes) and then start working.

 If the machine needs the repair, the repair must be done only by the service personnel assigned and trained by Tajima or qualified technician. (Consult your distributor.) Do not change the specification nor modify the parts of the machine without due consultation with Tajima. Such modification may have the risk against the operational safety.

 When restarting the machine after repairs, attach all covers etc. which were removed for repair operation.

 **CAUTION**

 For the repair, use Tajima genuine parts for replacement.

Chapter 11

Appendix

1. Spec. of the machine	238
2. Function code	243
3. Electrical system diagram.....	245
4. Terminology	247

1

2

3

4

5

6

7

8

9

10

11

1. Spec. of the machine

1-1. Power supply specifications

Since power spec. of the machine is specified clearly as shown below, use the machine under these conditions.



WARNING

 Since there is a danger of electric shock due to leak current, be sure to ground the earth cable of the machine. In addition, degree of grounding should be type D or higher (grounding resistance 100 ohms or less).

- (1) Voltage, allowable voltage range: 10% of the rated voltage
- (2) Power consumption (max)
 - Single head machine: 330 VA, 260 W
 - 2 or more head machine: 710 VA, 420 W
- (3) Frequency: 50/60 Hz
- (4) Insulation resistance: 10M ohms and larger (at 500 V Megger)

1-2. Ambient noise level

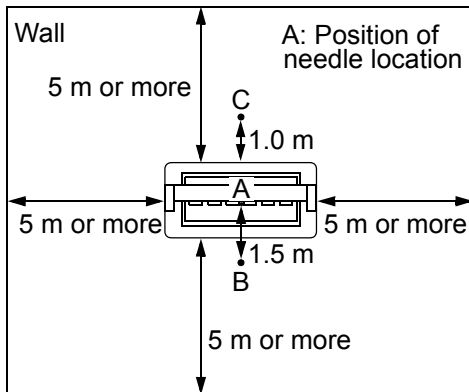
The ambient noise level of the machine is less than 85 db (single head machine: less than 82 db).
Measuring environment is as the figure below.



- (1) Measuring position
 - Higher value is adopted after measured at B and C. The height is measured at 1.6 m from the floor.
- (2) Working condition of the machine
 - Fabric is stretched on the border frame, and satin stitch sewing of stitch length 4 mm is executed.
- (3) RPM
 - The maximum number of revolutions of the machine
- (4) Measuring instrument
 - Conformity to IEC61672-1: 2002 Class 1

1-3. Switching of input voltage (some spec. only)

The following label (either of one) is stuck at the lower part of the power supply card. Only the model on which label No.3 is stuck can switch input voltage.

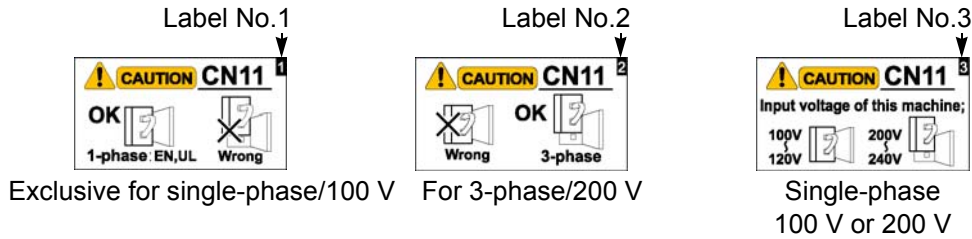

However, since the setting is performed according to your voltage spec. at shipment, it is not necessary to switch input voltage in usual usage. Perform switching of input voltage only in the following condition.

- (a) When the machine was moved for installation to the place whose voltage spec. is different from that at shipment
- (b) When you replace power supply card and connection of the connector CN11 is different from your voltage spec.

1-3-1. How to switch

DANGER

Since there could be danger of electric shock, perform the work after turning OFF the power.

In case of TFMX-C single-head machine and TWMX-C models

- (1) Detach the stand cover.
- (2) Change connection of the connector CN11 on the power supply card.

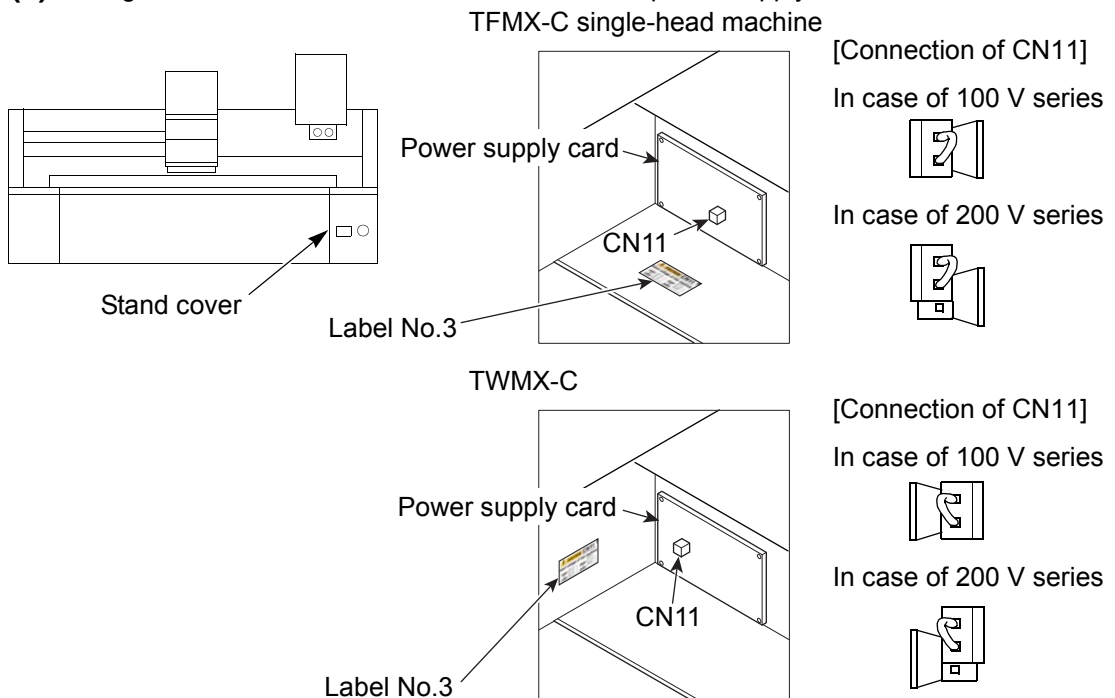

In case of 2 or more head machines

- (1) Detach the acrylic board.
- (2) Change connection of the connector CN11 on the power supply card.

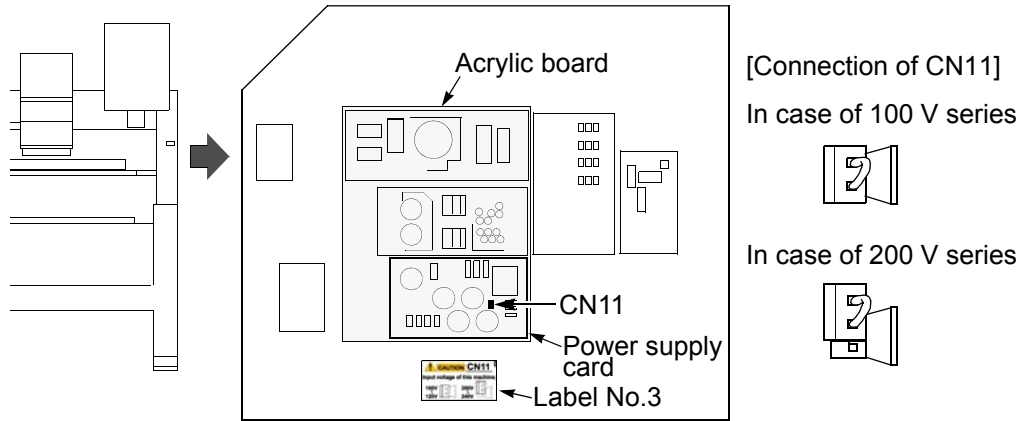

1-4. Layout of electrical component, card

DANGER

Since there could be danger of electric shock, other persons than service personnel certified by Tajima should not open the right-end box cover A, wiring cover B and Y-axis driver box C.

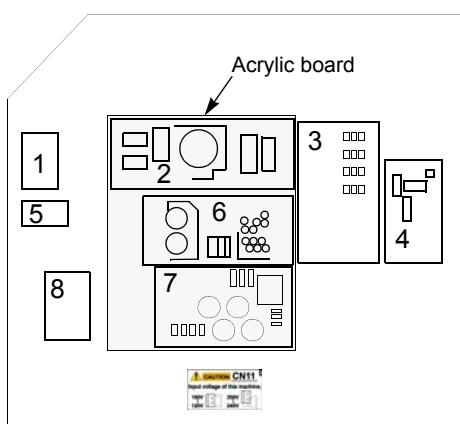

1. Breaker
2. DC 24 V power supply
3. Machine card
4. X-axis driver
5. Terminal base
6. DC 12/5 V power supply
7. Power supply card
8. Noise filter
9. Head card
10. Y-axis driver
11. Main shaft driver

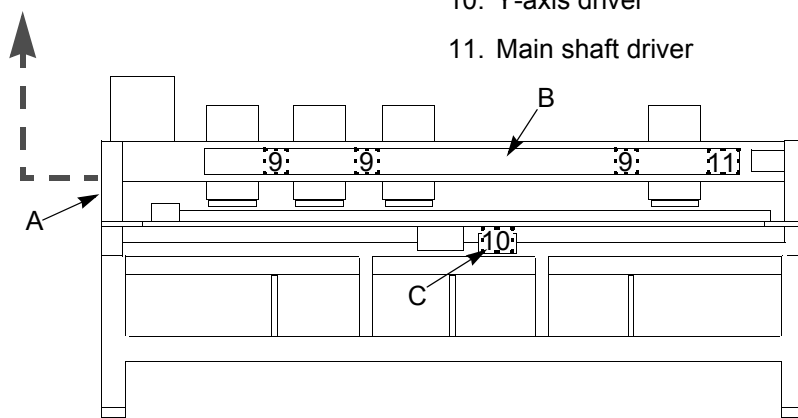

1-5. Machine weight

Since it is described on the spec. plate, please check (indicated by an arrow in the figure below).

Single head machine

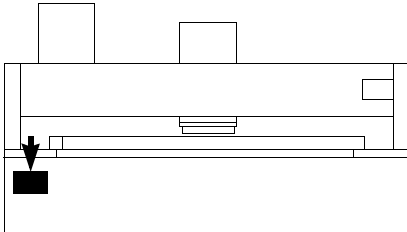

TFMX-IIC TYPE-2, TFMX (L)

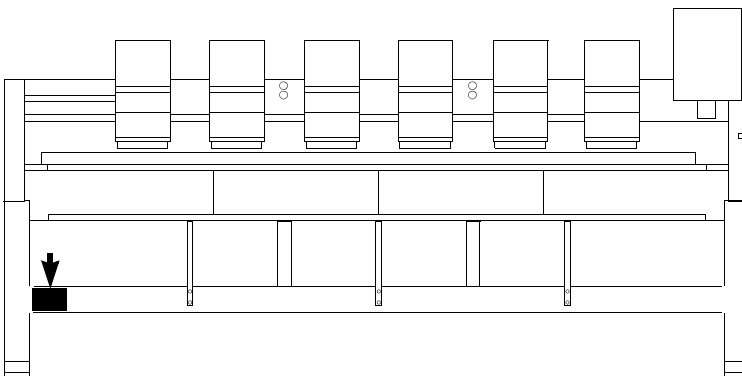

2. Function code

2-1. Function codes that can be edited by this machine

Function code	Function name	In case of saving design to a USB memory and selecting "T", data will be converted to the following function codes.
Stitch	Stitch	Stitch
Jump	Jump	Jump
Color	Color change	Stop
ATH	Upper/Under Thread ATH	Jump
Up_ATH	Upper Thread ATH	
Tmp_Stop	Temporary Stop Stitch	Stop
Tmp_Stop_J	Temporary Stop Jump	
Low_S	Low Speed Start Stitch	Stitch
Low_E	Low Speed End Stitch	
Low_S_J	Low Speed Start Jump	Jump
Low_E_J	Low Speed End Jump	
Satin_S	Satin Stitch Start	Stitch
Satin_E	Satin Stitch End	
Offset	Auto. Color Change Offsetting	
Sequin_S	Sequin Start	Sequin
Sequin_E	Sequin End	
Sequin_O	Sequin Output	Jump
Sequin_O_2	Sequin Output 2	Jump
Boring_S	Boring Start	Stitch
Boring_E	Boring End	
AFC_Feed	AFC frame feed	
End	End	End

2-2. Function codes that cannot be edited by this machine (display only)

Function code	Function name	In case of saving design to a USB memory and selecting "T", data will be converted to the following function codes.
Color_J	Color Change Jump	Stop
ATH_J	Upper/Under Thread ATH Jump	Jump
Up_ATH_J	Upper Thread ATH Jump	
Sequin_E_J	Sequin End Jump	Sequin
Sequin_O_J	Sequin Output Jump	Jump
Boring_1_J	Boring 1 Jump	Stitch
Boring_2_J	Boring 2 Jump	
Boring_3_J	Boring 3 Jump	
Boring_4_J	Boring 4 Jump	
Boring_S_J	Boring Start Jump	
Boring_E_J	Boring End Jump	
Loop	Looping	
Loop_J	Loop Stitch Jump	
Chain	Chain Stitch	
Chain_J	Chain Stitch Jump	
Laser_ON	Laser ON	
Laser_OFF	Laser OFF	
Laser_Pow	Laser Power Switching	
Laser_Lens	Laser Lens Switching	
Tape_Head	Tape Rewinding	
End_J	End Jump	

3. Electrical system diagram

3-1. Single-head machine

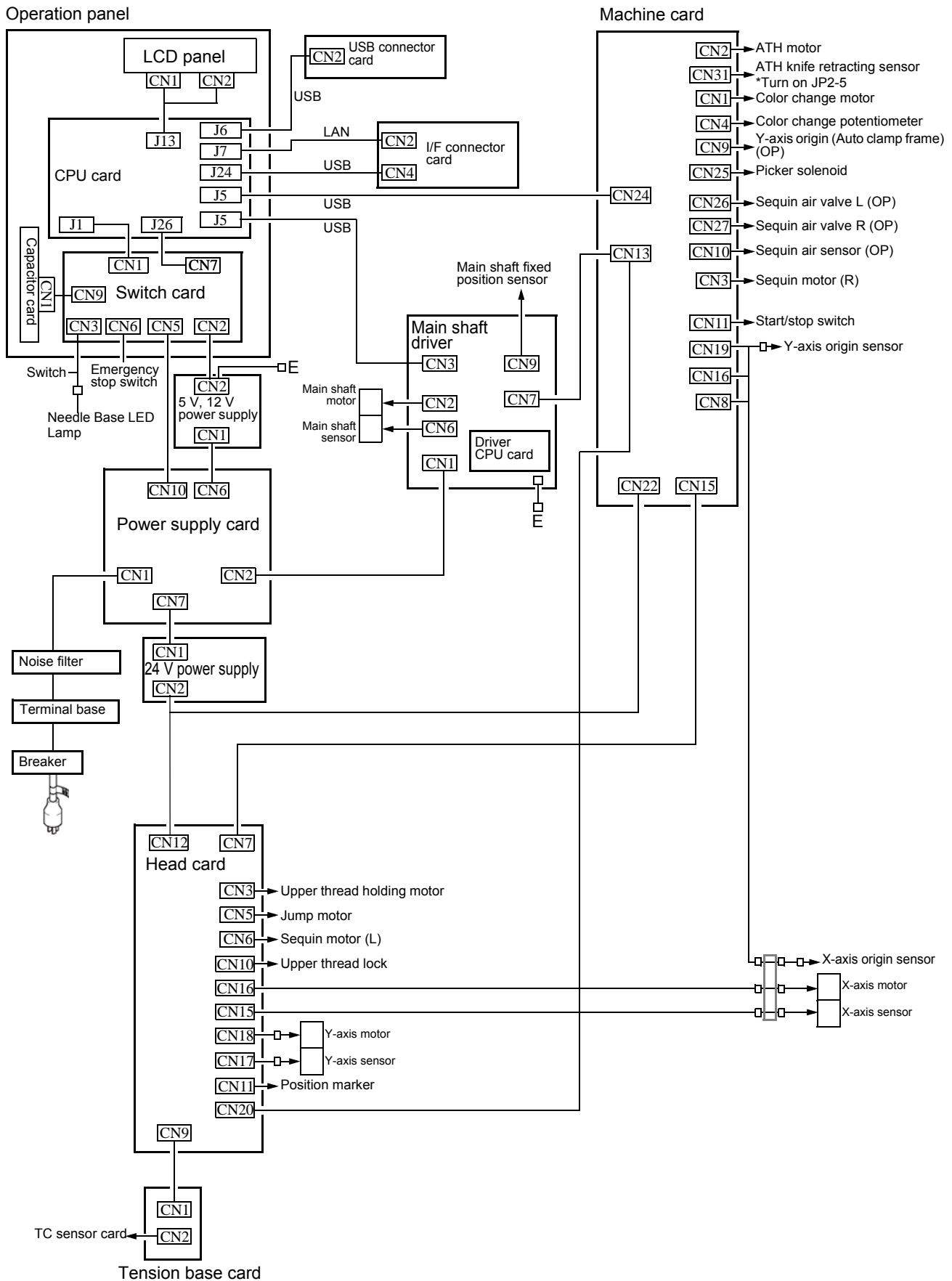

3-2. TFMX-IIC TYPE-2, TFMX (L)

Limit switch is equipped only to L-spec. machine.

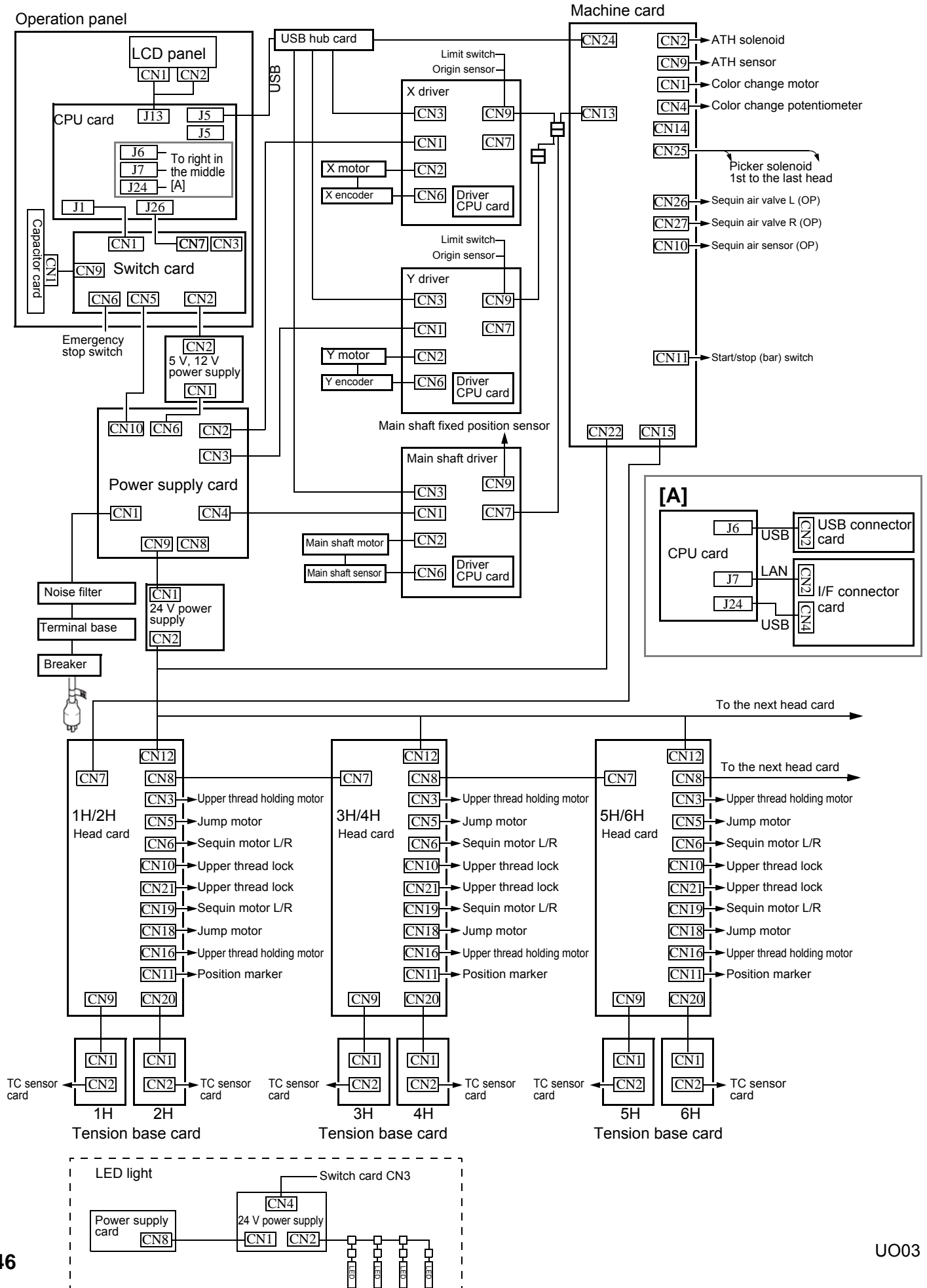

4. Terminology

The following terms apply to all models in common. There might be a case that it does not correspond depending on model.

<A>

Absolute origin

An anchoring point to calculate the current frame position (X: 0.0, Y:0.0).

ATH

Abbreviation of Automatic Thread Trimming and Holding Device.

Auto Jump

To make a stitch divided into stitches of the setting value or less automatically when its stitch length exceeds the setting value. It is effective to prevent the stepping out of the frame and the displacement of the design.

Backlash

A play (gap) generated by shock at drive system and/or around the frame when a stitch returns (when frame drive is reversed). It may affect finish of sewing.

<C>

Cleanup

To remove a fine stitch included in design data to make before and after stitches absorb it. It is effective to reduce thread breakage.

Condition data

Embroidery condition included in design data (needle bar selection, data conversion, repeat, design start position, automatic offset).

CT0

File including information of needle bar selection and design start position. It is necessary to handle TBF, CT0 and DGF as a set on a personal computer.

<D>

Data mode

Saving format of design data (T, T2, T3).

Data set

To input design data to the memory of the machine to start the machine.

D-axis

Driving shaft to rotate sewing needle or nipple (TCMX series).

DGF

File that indicates design image. It is necessary to handle TBF, CT0 and DGF as a set on a personal computer.

Driver

Control card to make the frame or main shaft drive. X-axis driver, Y-axis driver, main shaft driver etc. are included.

DST

Stitch data of Tajima ternary format. Data saving format is T.

<E>

Excitation

To keep frame motor drive. It is not possible to move the frame by hand during excitation.

<F>

Fine stitch

Short stitch such as it causes thread breakage. Stitch of which stitch length is 0.5 mm or less.

Fixed pitch movement

Horizontal frame travel to the neighboring head by head interval.

Fixed position

Angle of the main shaft at which the main shaft motor stops (stop position).

Frame Back

To move the embroidery frame only to the returning direction of stitches with the needle bar(s) stopped.

Frame coordinates

Frame position in embroidery space. It is indicated such as "X: -153.2, Y: +120.4".

Frame Forward

To move the embroidery frame only to the advancing direction of stitches with the needle bar(s) stopped.

Frame Limit

Limit position that the frame can move (it is indicated by mark-off line on the table).

Frame origin

An anchoring point to calculate the current frame position (X: 0.0, Y:0.0).

Frame stepping

To move the embroidery frame only with the main shaft of the machine kept stopped during embroidery.

Function code

Command code that controls general movements of the machine. All design data consists of function codes (Stitch, Jump, Color, etc.).

<H>**Head group**

Function that assumes plural heads as one head by grouping them. This enables large design embroidery or multi-colored embroidery of more colors than the number of needles.

<I>**Inching**

Movement to stabilize start of sewing by moving needle bar slowly before the main shaft starts usual operation. It is executed before thread trimming to stabilize thread trimming.

<J>**Jump**

To make only the frame move in the state that needle bar does not move down during operation. It is possible to make a longer stitch than one stitch of the maximum length.

<M>**M-axis**

Drive shaft to rotate nipple or bobbin (TLMX series).

<O>**Offset start position**

A frame travel start position set by operation of automatic offset. A position to make the machine stand by to facilitate changing of frame and/or fabric by moving the frame to the front automatically in the middle of sewing or at the end of sewing.

<P>**Parameter**

Setting item that decides working condition of the machine.

Pseudo-fixed position (stop at the lower dead point)

To stop the machine with needle stuck in cloth at end of embroidery. Moving the frame in this condition will enable consecutive embroidery.

<R>**Return Stitches**

Tie stitch to be executed at start of sewing (stitch to prevent mis-stitching at start).

Running stitch

Decorative stitch of straight line or curved line only.

<S>

Satin stitch

Repeated zigzag stitches. It is mainly used for hem of applique, logo, mark, flower design etc.

Sequin needle

Needle that sews sequins in sequin device. It indicates the first needle or the last needle.

Sidekick

Name of network application software manufactured by Pulse Microsystems Ltd. This software can input the design data into the machine memory by wireless LAN as a main function.

Step

The section divided by color change code in the design data. The first section is called step 1, and the next section is called step 2.

<T>

Table offset

To move the frame to the rear direction temporarily to facilitate threading. It is mainly effective when the frame is positioned at table cut section.

Tatami stitch

Stitch to be filled in a certain amount of area. It is mainly used for big logo, background, underlay etc.

TBF

Stitch data of Tajima binary format. Data saving format is T2. It can correspond much more function codes compared with DST. It is necessary to handle TBF, CT0 and DGF as a set on a personal computer.

TCF

Data integrating TBF, CT0 and DGF. Integration facilitates handling of design data. Data saving format is T3.

Tie Stitches

Tie stitch to be executed before thread trimming (stitch to prevent fray).

<W>

Weak brake (Main shaft motor brake)

To fix the main shaft by brake of the main shaft motor so that the main shaft does not rotate when it stops.

<X>

X-axis drive system

Drive system to make the embroidery frame move in crosswise (X) direction.

X data

Data to make the embroidery frame move in crosswise (X) direction. It is indicated by moving direction (code: +/-) and value (mm).

<Y>

Y-axis drive system

Drive system to make the embroidery frame move in lengthwise (Y) direction.

Y data

Data to make the embroidery frame move in lengthwise (Y) direction. It is indicated by moving direction (code: +/-) and value (mm).

<Z>

Z-axis

Driving shaft to change needle height (TCMX series).

Zigzag cord needle

Needle that sews cord in zigzag cording device. It indicates the first needle or the last needle.

A	
A certain head does not work	223
A.S. after Auto Data Set	103
Air Pressure Sensor	206
Ambient noise level	238
ATH Start Timing	88
Auto Jump	107
Auto Origin Return	163
Automatic Data Set after finishing embroidery.....	120
Automatic Offset.....	164
B	
Backlash.....	104
Bar switch.....	69
Bobbin changer	198
C	
Changing design name	176
Changing folder name	178
Cleaning	227
Cleanup	111
Color change speed	118
Condition data	31
Copy a design.....	174
Cording Device.....	196
D	
Data Conversion	98
Data conversion for sequin output	207
Data Edit "Delete"	130
Data Edit "Insert"	86, 126
Data Edit "Modify"	122
Data Input LAN.....	45
Data Setting	50
Decision of the design start position	57
Design rotation by 180 degrees on Cap Frame....	155
Design sort "in memory"	180
Design sort "USB".....	186
F	
Folder layer	41, 50
Frame Back.....	69, 146
Frame Drive Adjustment.....	115
Frame Forward.....	146
Frame Limit setting	96
Frame origin memory	159
Frame origin memory with the power-ON	160
Frame Start Timing.....	113
Frame Travel Speed.....	119
Function code	243
G	
Greasing.....	232
I	
Input confirmation of condition file.....	143
Inspection, Repair	235
J	
Jog remote-controller	23
Jump code combination	117
Jump Convert	85
K	
KB-2M.....	196
L	
LAN port	20
Language	140
Lubrication.....	229
M	
Main screen	26
Main Shaft Inching	117
Manual Color Change	78
Manual frame travel.....	59
Manual Offset	156
Manual Thread Trimming.....	79
Max. Revolution Limit.....	91
Maximum RPM.....	64
Memory Delete	172
Middle thread guide adjusting lever	67
Min. Revolution.....	89
Misreading by bar code reader.....	49
Movement of design	173

N	
Name of each part	14
Needle Bar Color	137
Needle bar information.....	138
Needle bar operation.....	58
Needle Bar Selection.....	53
Needle bar suspension lever	67
Network	193
O	
Operation panel.....	18
P	
Power resume	158
Power supply specifications.....	238
Power switch.....	34
Preset Halt	92
R	
Registration of a design into the machine memory	41
Repeat	100
Return the frame after manual frame travel.....	157
Return to the design start position	162
Return to the offset origin	168
Revolution limit	90
S	
Satin Stitch	105
Saving format of the design	41
Setting in units of Needle bar.....	108
Software Frame Limit.....	93
Software Version.....	139
Start point of design.....	32
Start/stop switch.....	68
Step	53
Stop at Lower D.Point	95
Stop Factor	214
Switching of input voltage.....	239
T	
Table offset position	169
Table offset switch	24
Tension base switch	66
Terminology	247
Thread breakage indicator lamp.....	66
Thread Detection	83
Thread passing.....	37
To change color automatically	55
To change frame type	152
To decide color change sequence	53
To execute by Stop code, to specify number of stitches to execute	147
To set All Head Sewing Start Point (Frame Back All Head Sew).....	150
To start operation automatically	55
To switch Frame Back / Frame Forward	146
To trim thread automatically (ATH).....	80
To turn ON the power.....	36
To use USB memory (Data Input USB)	41
Total Stitch Counter	136
Trace	62
Trouble examples and Corrective actions	221
U	
UBC II	198
Upper thread lock timing.....	114
USB "Save"	182
USB Delete	184
USB memory	20
W	
Warning labels.....	9
Weak brake.....	141



1st Edition June, 2004
45th Edition July, 2017

■ **Manufactured by:**
Tokai Industrial Sewing Machine Co., Ltd.

NO.1800, Ushiyama-cho, Kasugai, Aichi-pref., 486-0901, Japan
Telephone:568-33-1161 Fax:568-33-1191

■ **Distributed by:**
Tajima Industries Ltd.

19-22, Shirakabe, 3-chome, Higashi-ku, Nagoya, 461-0011, Japan
Telephone:52-932-3444 Fax:52-932-2457

●**Copy, reprint, or modification of all or any part of this manual without permission is prohibited.**